

СТ11-СТ12 СТ13-СТ14 СТ15-СТ19 СТ20-СТ23 СТ24-СТ27	РЕЖУЩИЕ ПЛАСТИНЫ и ИНСТРУМЕНТЫ POLY-V ПЛАСТИНЫ ДЛЯ ОБРАБОТКИ КАНАВОК ПОД КЛИНОВЫЕ РЕМНИ ПЛАСТИНЫ ДЛЯ ОБРАБОТКИ КАНАВОК Долбяки с СМП ИНСТРУМЕНТ ДЛЯ ОБРАБОТКИ ВКЛАДЫШЕЙ СЕДЛА КЛАПАНА ИНСТРУМЕНТ ДЛЯ ВИХРЕВОГО РЕЗЬБОФРЕЗЕРОВАНИЯ
СТ29 СТ30-СТ39 СТ40-СТ42 СТ43-СТ50 СТ51-СТ57 СТ58-СТ71 СТ71-СТ76	ДЕРЖАВКИ ДЛЯ НАРУЖНОГО ТОЧЕНИЯ ОБОЗНАЧЕНИЕ ДЕРЖАВОК ДЛЯ НАРУЖНОГО ТОЧЕНИЯ ПО ISO T-ТИП ДЕРЖАВКИ ДЛЯ НАРУЖНОГО ТОЧЕНИЯ M-ТИП ДЕРЖАВКИ ДЛЯ НАРУЖНОГО ТОЧЕНИЯ P-ТИП ДЕРЖАВКИ ДЛЯ НАРУЖНОГО ТОЧЕНИЯ C-ТИП ДЕРЖАВКИ ДЛЯ НАРУЖНОГО ТОЧЕНИЯ S-ТИП ДЕРЖАВКИ ДЛЯ НАРУЖНОГО ТОЧЕНИЯ S-ТИП ДЕРЖАВКИ ДЛЯ ШВЕЙЦАРСКИХ СТАНКОВ АВТОМАТОВ
СТ78 СТ79-СТ84 СТ85-СТ89 СТ90-СТ95 СТ96-СТ111	РАСТОЧНЫЕ ДЕРЖАВКИ СИСТЕМА ОБОЗНАЧЕНИЯ РАСТОЧНЫХ ДЕРЖАВОК ПО ISO T И C-ТИП РАСТОЧНЫЕ ДЕРЖАВКИ M-ТИП РАСТОЧНЫЕ ДЕРЖАВКИ P-ТИП РАСТОЧНЫЕ ДЕРЖАВКИ S-ТИП РАСТОЧНЫЕ ДЕРЖАВКИ
СТ113 СТ114-СТ115 СТ116-СТ118 СТ119-СТ121	КАРТРИДЖИ СИСТЕМА ОБОЗНАЧЕНИЯ КАРТРИДЖЕЙ ТИП-S ХОНИНГОВАННЫЕ КАРТРИДЖИ S-ТИП КАРТРИДЖИ P-ТИП КАРТРИДЖИ / ТОРЦОВОЧНАЯ ГОЛОВКА ДЛЯ ЦИЛИНДРИЧЕСКИХ ЗАГОТОВОК
СТ123 СТ124-СТ129	ДЕРЖАВКИ ДЛЯ НАРЕЗАНИЯ НАРУЖНОЙ РЕЗЬБЫ СИСТЕМА ОБОЗНАЧЕНИЯ ДЕРЖАВОК ДЛЯ НАРЕЗАНИЯ НАРУЖНОЙ РЕЗЬБЫ ДЕРЖАВКА ДЛЯ НАРЕЗАНИЯ НАРУЖНОЙ РЕЗЬБЫ / ТЕХНИЧЕСКИЕ РЕКОМЕНДАЦИИ ДЛЯ НАРЕЗАНИЯ РЕЗЬБЫ
СТ131 СТ132-СТ144 СТ144-СТ146 СТ147-СТ149 СТ149 СТ150-СТ151 СТ151 СТ152-СТ161	ДЕРЖАВКИ ДЛЯ ОБРАБОТКИ КАНАВОК СИСТЕМА ОБОЗНАЧЕНИЯ ДЕРЖАВОК ДЛЯ ОБРАБОТКИ КАНАВОК ДЕРЖАВКИ ДЛЯ ОБРАБОТКИ НАРУЖНЫХ КАНАВОК ДЕРЖАВКИ ДЛЯ ОБРАБОТКИ НАРУЖНЫХ КАНАВОК ДЛЯ ТОКАРНЫХ СТАНКОВ ШВЕЙЦАРСКОГО ТИПА ДЕРЖАВКИ ДЛЯ ОБРАБОТКИ ТОРЦЕВЫХ КАНАВОК ДЕРЖАВКИ L-ТИПА ДЛЯ ОБРАБОТКИ ТОРЦЕВЫХ КАНАВОК НОЖИ ДЛЯ ОТРЕЗКИ И ОБРАБОТКИ ГЛУБОКИХ КАНАВОК БЛОКИ К СМЕННЫМ НОЖАМ ДЛЯ ОТРЕЗКИ И ОБРАБОТКИ ГЛУБОКИХ КАНАВОК ДЕРЖАВКИ ДЛЯ ОБРАБОТКИ ВНУТРЕННИХ КАНАВОК
СТ165-СТ188 СТ189-СТ190 СТ191 СТ192 СТ195-СТ196 СТ198-СТ202	ИНСТРУМЕНТ ДЛЯ СВЕРЛЕНИЯ И ОБРАБОТКИ ОТВЕРСТИЙ СВЕРЛА / СИСТЕМА ОБОЗНАЧЕНИЯ СВЕРЕЛ КОЛЬЦА ДЛЯ СНЯТИЯ ФАСКИ / ЭКСЦЕНТРИЧЕСКИЙ АДАПТЕР ДЛЯ СВЕРЕЛ ЭКСЦЕНТРИЧЕСКИЙ АДАПТЕР ДЛЯ СВЕРЕЛ ФОРМА ЗАКАЗА СПЕЦИАЛЬНЫХ СВЕРЕЛ ЭКОНОМИЧНЫЙ MULTI TOOL / СИСТЕМА ОБОЗНАЧЕНИЯ MULTI TOOL РЕГУЛИРУЕМЫЕ РАСТОЧНЫЕ ГОЛОВКИ / СИСТЕМА ОБОЗНАЧЕНИЙ РЕГУЛИРУЕМЫХ РАСТОЧНЫХ ГОЛОВОК
СТ204 СТ205-СТ206 СТ206 СТ207 СТ208-СТ231 СТ232-СТ234 СТ235-СТ244 СТ244-СТ252 СТ253-СТ260 СТ260-СТ262 СТ262-СТ263 СТ264 СТ265-СТ266 СТ267 СТ268-СТ299 СТ300-СТ303 СТ304-СТ306 СТ307-СТ313 СТ314-СТ315 СТ316-СТ317 СТ318-СТ323	ФРЕЗЕРНЫЙ ИНСТРУМЕНТ СИСТЕМА ОБОЗНАЧЕНИЙ ФРЕЗЕРНОГО ИНСТРУМЕНТА S-ТИП КОНЦЕВЫЕ ФРЕЗЫ ДЛЯ СНЯТИЯ ФАСКИ (ЗЕНКОВКИ) СПИРАЛЬНЫЕ ФРЕЗЫ ДЛЯ СНЯТИЯ ФАСКИ ЗЕНКОВКА ДЛЯ ОТВЕРСТИЙ ПОД ВИНТЫ С ЦИЛИНДРИЧЕСКОЙ И ШЕСТИГРАННОЙ ГОЛОВКОЙ (DIN 974-1) S-ТИП КОНЦЕВЫЕ ФРЕЗЫ S-ТИП КОНЦЕВЫЕ РАДИУСНЫЕ ФРЕЗЫ S-ТИП ВЫСОКОПРОИЗВОДИТЕЛЬНЫЕ КОНЦЕВЫЕ ФРЕЗЫ S-ТИП СМЕННЫЕ ФРЕЗЕРНЫЕ ГОЛОВКИ (КРЕПЛЕНИЕ ПОД РЕЗЬБУ) S-ТИП СМЕННЫЕ ФРЕЗЕРНЫЕ ГОЛОВКИ (КРЕПЛЕНИЕ ПОД РЕЗЬБУ) СФЕРИЧЕСКИЕ КОНЦЕВЫЕ ФРЕЗЫ S-ТИП СМЕННЫЕ СФЕРИЧЕСКИЕ ФРЕЗЕРНЫЕ ГОЛОВКИ (КРЕПЛЕНИЕ ПОД РЕЗЬБУ) ОПРАВКИ ДЛЯ СМЕННЫХ ГОЛОВОК РЕЗЬБОНАРЕЗНЫЕ ФРЕЗЫ S-ТИП СПИРАЛЬНАЯ КОНЦЕВАЯ ФРЕЗА (КУКУРУЗНАЯ ФРЕЗА) ТОРЦЕВЫЕ ФРЕЗЫ ТОРЦЕВЫЕ И КОПИРОВАЛЬНЫЕ ФРЕЗЫ C-ТИП ТОРЦЕВЫЕ ФРЕЗЫ ВЫСОКОПРОИЗВОДИТЕЛЬНЫЕ ТОРЦЕВЫЕ ФРЕЗЫ T-ОБРАЗНЫЕ ФРЕЗЫ ДИСКОВЫЕ ТРЕХСТОРОННИЕ ФРЕЗЫ ИНСТРУКЦИЯ ПО УСТАНОВКЕ ФРЕЗ И ТЕХНИЧЕСКАЯ ИНФОРМАЦИЯ
СТ324-СТ337 СТ338-СТ339	ЗАПАСТНЫЕ ЧАСТИ ЗАПАСТНЫЕ ЧАСТИ СОДЕРЖАНИЕ

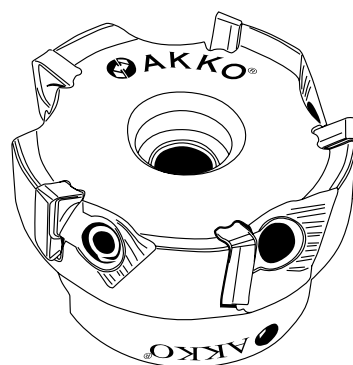

konusulan
the spoken kalite...
quality...

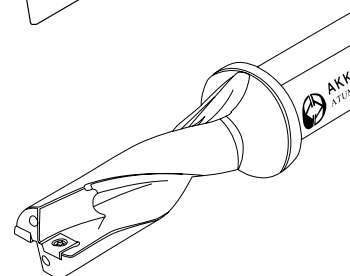

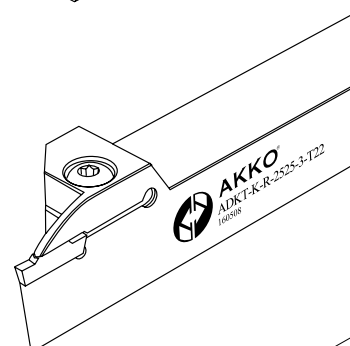
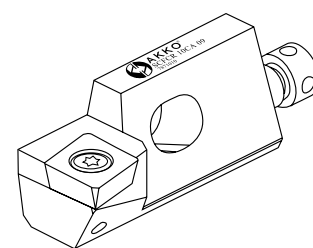
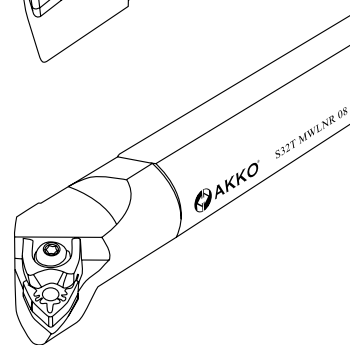
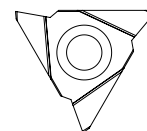

KESİCİ UÇLAR ve TAKIMLARI
CUTTING INSERTS and TOOLHOLDERS
РЕЖУЩИЕ ПЛАСТИНЫ и ИНСТРУМЕНТЫ



POLY-V

POLY-V KANAL AÇMA UÇLARI ve TAKIMLARI
POLY-V GROOVING INSERTS and TOOLHOLDERS
ПОLY-V ПЛАСТИНЫ ДЛЯ ОБРАБОТКИ КАНАВОК ПОД
КЛИНОВЫЕ РЕМНИ



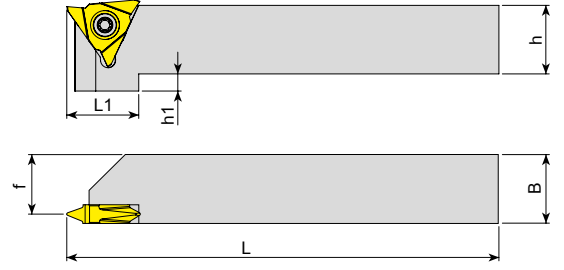

Takım Kodu Ordering Code Код для заказа	Stok Stock Наличие		Takım Ölçüleri (mm) Dimension (mm) Размеры (мм)					Kesici Uç Insert Пластина	Yedek Parçaları / Spare Parts / Запасные части		
	R	L	h	B	f	L	L1		h1	Sıkma Vidası Screw Зажимной винт	Tork Anahtar Torx Key Торх Ключ
ADKT-T12P-R/L-1616-T5	●	●	16	16	13.50	125	21	5	T12...	1020-M5x11	80-T20
ADKT-T12P-R/L-2020-T5	●	●	20	20	17.50	125	21	5			
ADKT-T12P-R/L-2525-T5	●	●	25	25	22.50	150	-	-		1020-M5x14	
ADKT-T12P-R/L-3232-T5	●	●	32	32	29.50	170	-	-			

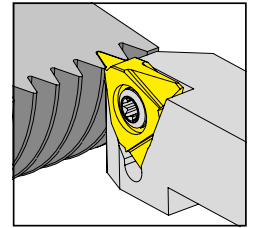
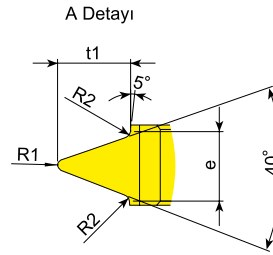
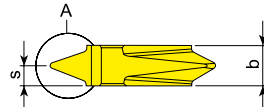
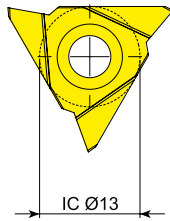
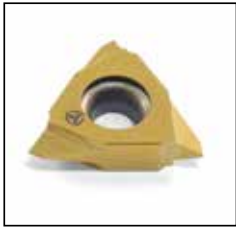

Uç Kodu Insert Code Код Пластина	Stok Stock Наличие	Uç Ölçüleri (mm) Insert Dimension (mm) Размеры (мм)						Kalite Grade Марка твердого сплава
		e	b	R1	R2	S	t1	
T12.10.0234.PJ.R	●	2.34	5.20	0.25	0.20	2.60	2.30	VK20F01
T12.10.0356.PK.R	●	3.56	5.20	0.35	0.25	2.60	3.69	VK20F01
T12.10.0470.PL.R	●	4.70	5.20	0.33	0.40	2.60	5.02	VK20F01

ADKT-T12P...Tipi katerler ile kullanınız. / Use with ADKT-T12P... Type toolholder. / Используйте резцы Тип ADKT-T12P ...

İndekslediğinde boy $\pm 0,02$ mm / Indexability length $\pm 0,02$ mm / Индексруемая длина $\pm 0,02$ мм

Diğer ölçü talepleriniz için müşteri temsilciniz ile irtibata geçiniz. / For other dimension request, contact with customer representative. / Для запроса другого размера, свяжитесь с работником компании.

KANAL AÇMA

KANAL AÇMA, KÖŞE BOŞALTIMA UÇLARI ve TAKIMLARI
INSERTS and TOOLHOLDERS FOR GROOVING CORNER RELIEFS
ПЛАСТИНЫ ДЛЯ ОБРАБОТКИ КАНАВOK



AKKO®
AAUT-T20-R-



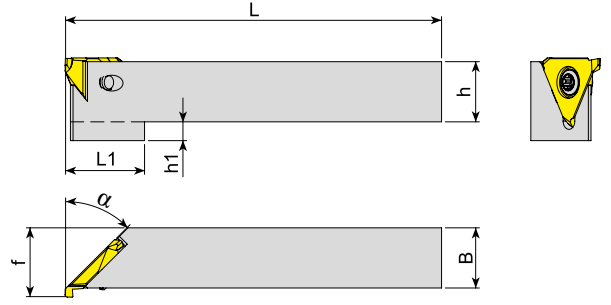

Takım Kodu Ordering Code Код для заказа	Stok Stock Наличие		Takım Ölçüleri (mm) Dimension (mm) Размеры (мм)							Kesici Uç Insert Пластина	Sıkma Vidası Screw Зажимной винт	Tork Anahtar Torx Key Торх Ключ
	R	L	h	B	f	L	L1	h1	α			
AAUT-T20-R/L-1616-45	●	○	16	16	18.3	125	21	5	45°	T20...	1020-M5x7.5	80-T20
AAUT-T20-R/L-2020-45	●	○	20	20	22.3	125	21	5	45°			
AAUT-T20-R/L-2525-45	●	○	25	25	27.3	150	-	-	45°			

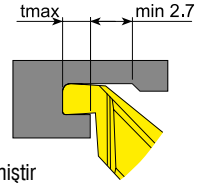
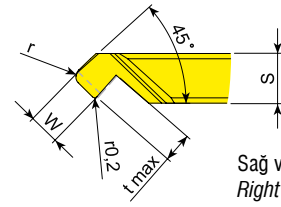
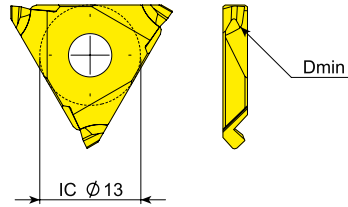

Sağ versiyon gösterilmiştir
 Right hand version shown
 Показана правая версия

Uç Kodu Insert Code Код Пластина	Stok Stock Наличие	Uç Ölçüleri (mm) Insert Dimension (mm) Размеры (мм)					Kalite Grade Марка твердого сплава	Minimum Çap Ø Minimum Diameter Ø Минимум Диаметр Ø	Kanal Derinliği Depth of Groove Up to Глубина канавки	Kanal Genişliği Width of Groove Ширина канавки
		W	S	r	t max	D min				
T20.00.0815.45.04R	●	1.5	3.25	0.4	1.6	8	VK20F01	8 mm	2 mm	1.5-2.4 mm
T20.00.1220.45.05R	●	2.0	3.25	0.5	1.8	12	VK20F01			
T20.00.2024.45.06R	●	2.4	3.25	0.6	2.0	20	VK20F01			

AAUT.. Tipi katerlerle kullanınız. / Use with AAUT type toolholder. / Используйте резцы Тип ADKT-T12P...

Kullanım öncesinde dip boşluk işlenmiş olmalıdır. / The undercut must be placed before axial machining. / Перед использованием нижняя стенка должна быть обработано индексlendiğinde boy ± 0.02 mm / Indexability length ± 0.02 mm / Индексруемая длина $\pm 0,02$ мм

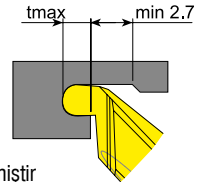
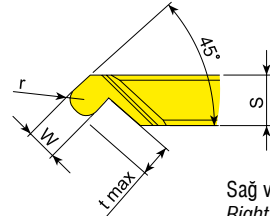
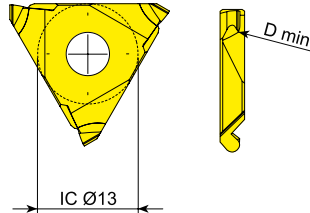
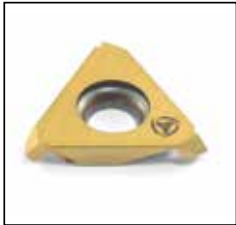

Sağ versiyon gösterilmiştir
 Right hand version shown
 Показана правая версия

Uç Kodu Insert Code Код Пластина	Stok Stock Наличие	Uç Ölçüleri (mm) Insert Dimension (mm) Размеры (мм)					Kalite Grade Марка твердого сплава	Minimum Çap Ø Minimum Diameter Ø Минимум Диаметр Ø	Kanal Derinliği Depth of Groove Up to Глубина канавки	Kanal Genişliği Width of Groove Ширина канавки
		W	S	r	t max	D min				
T20.00.1220.45.20R	●	2.0	3.25	2.0	1.8	12	VK20F01	12 mm	2 mm	2 mm

AAUT.. Tipi katerlerle kullanınız. / Use with AAUT type toolholder. / Используйте резцы Тип ADKT-T12P...

Kullanım öncesinde dip boşluk işlenmiş olmalıdır. / The undercut must be placed before axial machining. / Перед использованием нижняя стенка должна быть обработано индексlendiğinde boy ± 0.02 mm / Indexability length ± 0.02 mm / Индексруемая длина $\pm 0,02$ мм

BROŞ

BROŞ ÇEKME UÇLARI ve TAKIMLARI
BROACHING INSERTS and TOOLHOLDERS
Долбяки с СМП



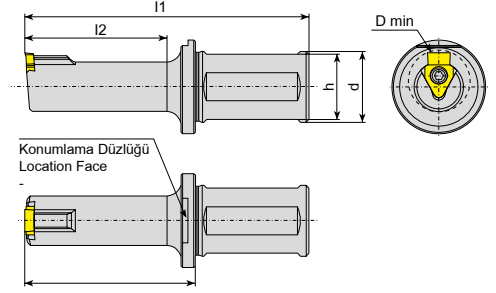

Takım Kodu Ordering Code Код для заказа	Stok Stock Наличие	Takım Ölçüleri (mm) Dimension (mm) Размеры (мм)						Kesici Uç Insert Пластина	Yedek Parçaları / Spare Parts / Запасные части	
		D min	l2	d	l1	l	h		Sıkma Vidası Screw Зажимной винт	Tork Anahtar Torx Key Торх Ключ
ABT-B41-D17-Y25-L90-I040	●	17	40	25	90	50	23	B41...	4015-M4x11	80-T15
ABT-B41-D17-Y25-L105-I065	●	17	65	25	105	75	23			
ABT-B41-D22-Y25-L100-I050	●	22	50	25	100	60	23			
ABT-B41-D22-Y25-L125-I070	●	22	70	25	125	80	23			
ABT-B42-D30-Y32-L100-I050	●	30	50	32	100	60	30	B42...	1020-M5x14	80-T20
ABT-B42-D30-Y32-L125-I075	●	30	75	32	125	85	30			
ABT-B42-D30-Y32-L170-I110	●	30	110	32	170	120	30			
ABT-B42-D38-Y32-L100-I050	●	38	50	32	100	60	30			
ABT-B42-D38-Y32-L125-I075	●	38	75	32	125	85	30			
ABT-B42-D40-Y32-L100-I050	●	40	50	32	100	60	30			
ABT-B42-D40-Y32-L125-I075	●	40	75	32	125	85	30			



DIN138 (Tolerans C11) torna ve freze tezgahlarında broş çekme uçları.
 DIN138 (Tolerance C11) inserts for keyway broaching on lathe and milling machines.
 Допуск на ширину обработанной канавки C11 по DIN138.

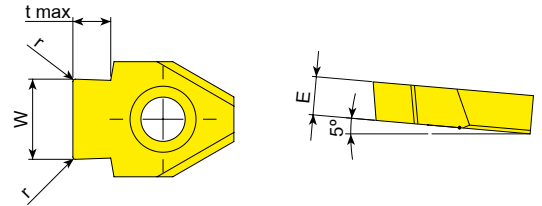

Uç Kodu Insert Code Код Пластина	Stok Stock Наличие	Uç Ölçüleri (mm) Insert Dimension (mm) Размеры (мм)				
		W	r	t max	E	Dmin
B41.00.0612.085.VP3001	●	6.12	0.85	2.6	4.0	22
B41.00.0713.085.VP3001	●	7.13	0.85	3.3	4.0	22
B41.00.0813.105.VP3001	●	8.13	1.05	3.4	4.0	22
B42.00.1013.105.VP3001	●	10.13	1.05	4.2	6.0	30
B42.00.1215.135.VP3001	●	12.15	1.35	5.1	6.0	38
B42.00.1215.175.VP3001	●	12.15	1.75	6.6	6.0	38
B42.00.1215.225.VP3001	●	12.15	2.25	8.5	6.0	38

Tipik kesme şartları / Typical cutting conditions / Типичные условия резания: İlerleme (Vf): 3000-8000 mm/dak (min) / Paso (ap): 0.02-0.08 mm / Подача 3000-8000 мм/мин



DIN6885 (Tolerans P9) torna ve freze tezgahlarında broş çekme uçları.
DIN6885 (Tolerance P9) inserts for keyway broaching on lathe and milling machines.
Допуск на ширину обработанной канавки P9 под шпонку ГОСТ 23360-78.

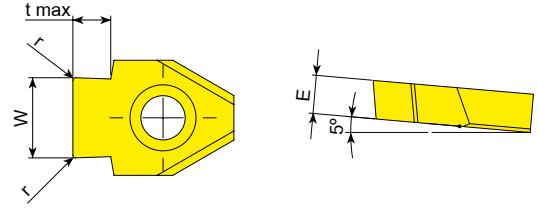

Uç Kodu Insert Code Код Пластина	Stok Stock Наличие	Uç Ölçüleri (mm) Insert Dimension (mm) Размеры (мм)				
		W	r	t max	E	Dmin
B41.00.0498.020.VP3001	●	4.98	0.20	2.7	4.0	17
B41.00.0598.020.VP3001	●	5.98	0.20	3.4	4.0	17
B41.00.0798.020.VP3001	●	7.98	0.20	4.1	4.0	22
B42.00.0998.030.VP3001	●	9.98	0.30	4.2	6.0	30
B42.00.1197.030.VP3001	●	11.97	0.30	5.7	6.0	38
B42.00.1397.030.VP3001	●	13.97	0.30	6.8	6.0	40

Tipik kesme şartları / Typical cutting conditions / Типичные условия резания: İlerleme (Vf): 3000-8000 mm/dak (min) / Paso (ap): 0,02-0,08 mm



DIN6885 (Tolerans JS9) torna ve freze tezgahlarında broş çekme uçları.
DIN6885 (Tolerance JS9) inserts for keyway broaching on lathe and milling machines.
Допуск на ширину обработанной канавки JS9 под шпонку ГОСТ 23360-78.

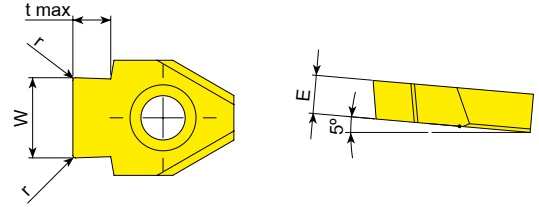

Uç Kodu Insert Code Код Пластина	Stok Stock Наличие	Uç Ölçüleri (mm) Insert Dimension (mm) Размеры (мм)				
		W	r	t max	E	Dmin
B41.00.0501.020.VP3001	●	5.01	0.20	2.7	4.0	17
B41.00.0601.020.VP3001	●	6.01	0.20	3.4	4.0	17
B41.00.0801.020.VP3001	●	8.01	0.20	4.1	4.0	22
B42.00.1001.030.VP3001	●	10.01	0.30	4.2	6.0	30
B42.00.1200.050.VP3001	●	12.00	0.50	8.5	6.0	38
B42.00.1201.030.VP3001	●	12.01	0.30	5.7	6.0	38
B42.00.1401.030.VP3001	●	14.01	0.30	6.8	6.0	40

Tipik kesme şartları / Typical cutting conditions / Типичные условия резания: İlerleme (Vf): 3000-8000 mm/dak (min) / Paso (ap): 0.02-0.08 mm / Подача 3000-8000 мм/мин



Torna ve freze tezgahlarında
kama kanalı pah kırma uçları.
Inserts for keyway chamfering on
lathe and milling machines.

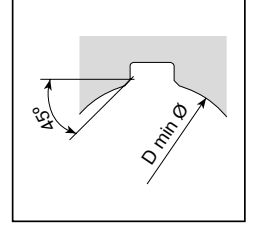
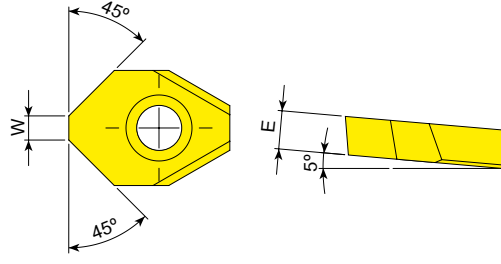

Uç Kodu Insert Code Код Пластина	Stok Stock Наличие	Uç Ölçüleri (mm) Insert Dimension (mm) Размеры (мм)		
		D min	W	E
B41.00.0150.CH.VP3001	●	17	1.5	4.0
B41.00.0300.CH.VP3001	●	22	3.0	4.0
B42.00.0600.CH.VP3001	●	30	6.0	6.0

Tipik kesme şartları / Typical cutting conditions / Типичные условия резания: İlerleme (Vf): 3000-8000 mm/dak (min) / Paso (ap): 0.02-0.08 mm / Подача 3000-8000 мм/мин

PROFİL VERİLMİŞ UÇLAR / PROFILED INSERTS / КАРТИНКА ПЛАСТИН В ПРОФИЛЬ
ÖRNEK PROFİLLER / EXAMPLES OF PROFILES / ПРИМЕРЫ ПРОФИЛЕЙ

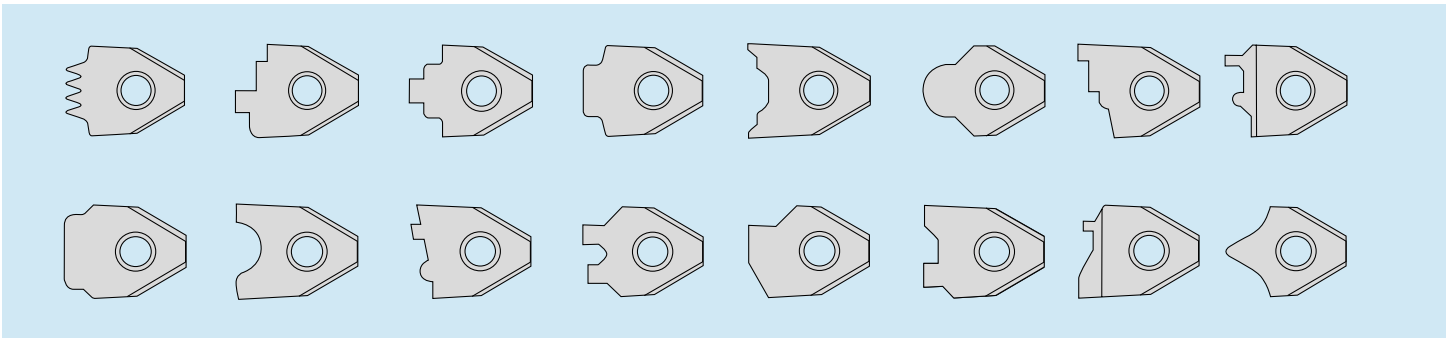

Profil uçlar müşterilerimizin özel taleplerine göre üretilmektedir.
Profiled inserts are manufactured according to customer special requirements.
Профилированные пластины изготавливаются в соответствии с особыми требованиями заказчика

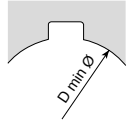
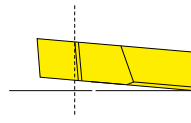
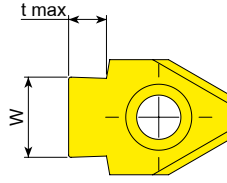

Kanal Genişliği Slot With Ширина канавки	Tolerans Tolerance Толерансы	Uç Ölçüsü Insert Size mm Размеры (мм)	W	t max	Uçlar Inserts Пластины	Uygulanabilir takım ve uç bağlantısı ile Dmin tablosu Applicable Dmin for toolholders and inserts table Таблица Dmin для инструмента и пластин				
						ABT-B41-D17...	ABT-B41-D22...	ABT-B42-D30...	ABT-B42-D38...	ABT-B42-D40...
6	C11	6	6.12	2.6	B41.00.0612.085.VP3001		22	X	X	X
7		7	7.13	3.3	B41.00.0713.085.VP3001		27	X	X	X
8		8	8.13	3.4	B41.00.0813.105.VP3001		32	X	X	X
10		10	10.13	4.2	B42.00.1013.105.VP3001	X	X		40	
12		12		5.1	B42.00.1215.135.VP3001	X	X		50	
16		12	12.15	6.6	B42.00.1215.175.VP3001	X	X		70	
24		12		8.5	B42.00.1215.225.VP3001	X	X		100	
5	P9	5	4.98	2.7	B41.00.0498.020.VP3001	17		X	X	X
6		6	5.98	3.4	B41.00.0598.020.VP3001	17		X	X	X
8		8	7.98	4.1	B41.00.0798.020.VP3001		22	X	X	X
10		10	9.98	4.2	B42.00.0998.030.VP3001	X	X	30		
12		12	11.97	5.7	B42.00.1197.030.VP3001	X	X		38	
14		14	13.97	6.8	B42.00.1397.030.VP3001	X	X			40
5	JS9	5	5.01	2.7	B41.00.0501.020.VP3001	17		X	X	X
6		6	6.01	3.4	B41.00.0601.020.VP3001	17		X	X	X
8		8	8.01	4.1	B41.00.0801.020.VP3001		22	X	X	X
10		10	10.01	4.2	B42.00.1001.030.VP3001	X	X	30		
12		12	12.00	8.5	B42.00.1200.050.VP3001	X	X		38	
12		12	12.01	5.7	B42.00.1201.030.VP3001	X	X		38	
14		14	14.01	6.8	B42.00.1401.030.VP3001	X	X			40

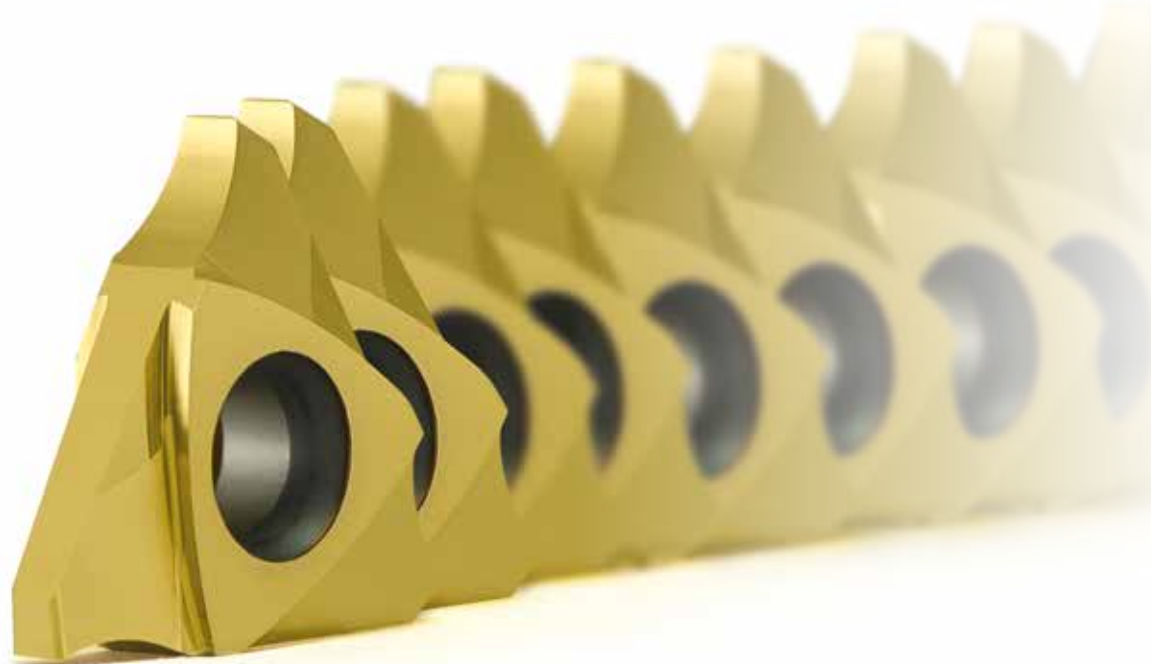

SUPAP

SUPAP YUVASI İŞLEME UÇLARI ve TAKIMLARI
VALVE SEAT INSERTS and TOOLHOLDERS
ИНСТРУМЕНТ ДЛЯ ОБРАБОТКИ ВКЛАДЫШЕЙ СЕДЛА
КЛАПАНА



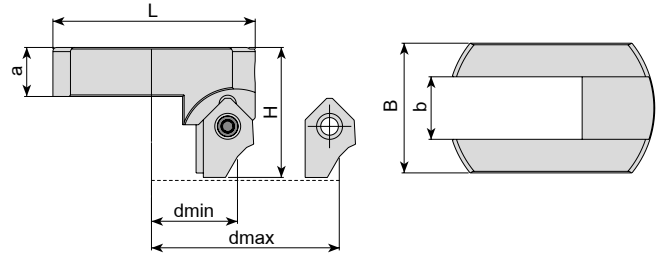

Takım Kodu Ordering Code Код для заказа	Stok Stock Наличие	Takım Ölçüleri (mm) Dimension (mm) Размеры (мм)						Yedek Parçaları / Spare Parts / Запасные части				
		D min max	L	a	H	b	B	Kesici Uç Insert Пластина	Sıkma Vidası Screw Зажимной винт	Tork Anahtar Torx Key Торх Ключ	Ayar Vidası Adjustable Регулировочный винт	Anahtar Allen Key Ключ
VST-B11-1830	●	18-30	29	9.4	28.5	12	25.0					
VST-B11-2842	●	28-42	39	9.4	25.0	12	25.0	B11...	3008-M3X8	80-T08	2702-M4x10	AAL-01-02

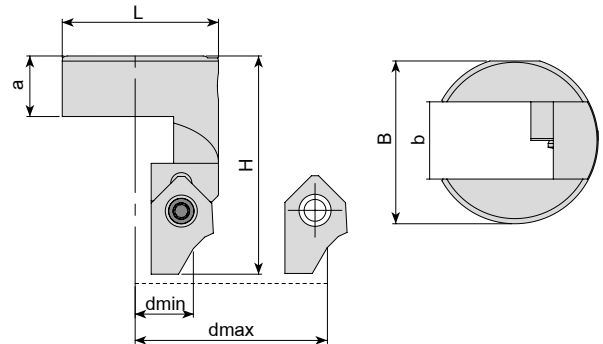

Takım Kodu Ordering Code Код для заказа	Stok Stock Наличие	Takım Ölçüleri (mm) Dimension (mm) Размеры (мм)						Yedek Parçaları / Spare Parts / Запасные части				
		D min max	L	a	H	b	B	Kesici Uç Insert Пластина	Sıkma Vidası Screw Зажимной винт	Tork Anahtar Torx Key Торх Ключ	Ayar Vidası Adjustable Регулировочный винт	Anahtar Allen Key Ключ
VST-B11-4058	●	40-58	24	9.4	34.0	12	25.3	B11...	3008-M3X8	80-T08	2702-M4x10	AAL-01-02

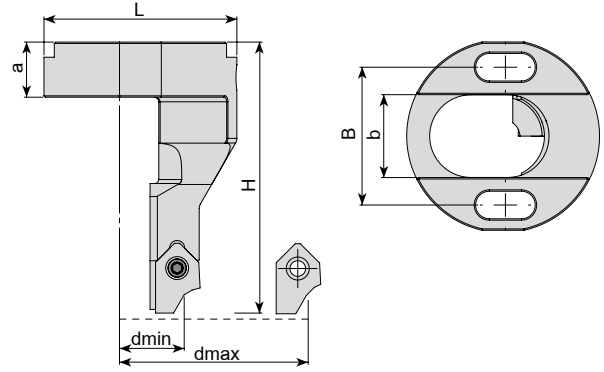

Takım Kodu Ordering Code Код для заказа	Stok Stock Наличие	Takım Ölçüleri (mm) Dimension (mm) Размеры (мм)						Kesici Uç Insert Пластина	Yedek Parçaları / Spare Parts / Запасные части								
		D min max	L	a	H	b	B		Sıkma Vidası Screw Зажимной винт	Tork Anahtar Torx Key Торх Ключ	Ayar Vidası Adjustable Регулируемый винт	Anahtar Allen Key Ключ					
VST-B11-2032	●	20-32	42	12	59	18	30						B11...	3008-M3X8	80-T08	2702-M4x10	AAL-01-02

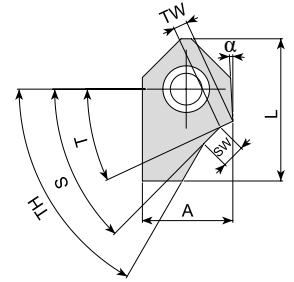

Uç Kodu Insert Code Код Пластины	Stok Stock Наличие	Uç Ölçüleri (mm) Insert Dimension (mm) Размеры (мм)							
		S	SW	T	TW	TH	A	L	α
B11003	●	45	1.3	25	1.1	52	9.7	15.25	3°
B11004	●	45	1.6	25	1.3	52	9.7	15.25	3°
B11005	●	45	2	25	1.3	52	9.7	15.25	3°
B11006	●	45	2.5	25	1.5	52	9.7	15.25	3°
B11007	●	45	1.5	30	1.5	60	9.7	15.25	3°
B11008	●	45	1.3	25	1.1	60	9.7	15.25	3°
B11009	●	45	1.6	25	1.3	60	9.7	15.25	3°
B11010	●	45	2	25	1.3	60	9.7	15.25	3°
B11011	●	30	2	15	1.8	60	9.7	15.25	3°
B11012	●	36	2	15	1.6	60	9.7	15.25	3°
B11014	●	45	2.5	25	1.5	60	9.7	15.25	3°
B11016	●	30	1.5	15	1.3	60	9.7	15.25	3°
B11017	●	30	2.5	15	1.8	60	9.7	15.25	3°
B11018	●	36	2.5	15	1.6	60	9.7	15.25	3°
B11019	●	20	2.5	10	2	75	9.7	15.25	3°
B11020	●	45	1.3	25	1.1	52	7.7	15.25	3°
B11021	●	30	3	15	1.8	60	9.7	15.25	3°
B11022	●	45	3	30	1.8	60	9.7	15.25	3°

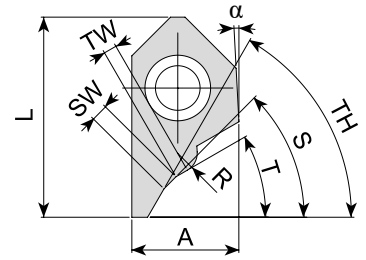

Uç Kodu Insert Code Код Пластины	Stok Stock Наличие	Uç Ölçüleri (mm) Insert Dimension (mm) Размеры (мм)								
		S	SW	T	TW	TH	A	L	α	R
B11013	●	45	1.3	30	1	60	8.15	15.25	3°	1.50

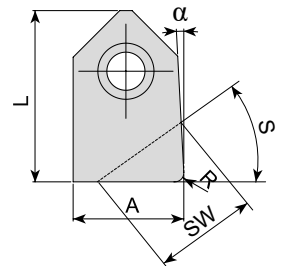

Uç Kodu Insert Code Код Пластины	Stok Stock Наличие	Uç Ölçüleri (mm) Insert Dimension (mm) Размеры (мм)					
		S	SW	A	L	α	R
B11015	●	0°	9.85	9.85	15.25	3°	0.80
B11023	●	0°	7.7	7.7	15.25	3°	0.80
B11024	●	20°	8.2	9.75	15.25	3°	0.80
B11025	●	25°	10	9.65	15.25	3°	0.80
B11026	●	30°	9	9.65	15.25	3°	0.80
B11027	●	35°	10	9.60	15.25	3°	0.80
B11028	●	45°	8.9	9.55	15.25	3°	0.80

WHIRLING

WHIRLING UÇLARI ve TAKIMLARI
WHIRLING INSERTS and TOOLHOLDERS
ИНСТРУМЕНТ ДЛЯ ВИХРЕВОГО РЕЗЬБОФРЕЗЕРОВАНИЯ



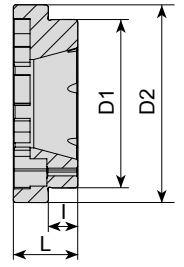
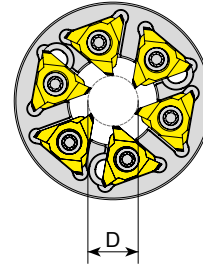

Makine Machine Станок	Tahrikli Whirling Ünitesi Aggregate Whirling Unit	Whirling Ring Kodu Whirling Ring Code Whirling Ring Код	Stok Stock Наличие	Takım Ölçüleri (mm) Dimension (mm) Размеры (мм)						Kesici Uç Insert Пластина	Yedek Parçaları / Spare Parts / Запасные части		
				Z	D	D1	D2	I	L		Sıkma Vidası Screw Зажимной винт	Tork Anahtar Torx Key Торх Ключ	
STAR	5914 72 00/68172	ATW-301-T09-D1240-Z06	●	6	12	40	47	7	15				
	BTW1000	ATW-302-T09-D1233-Z06	○	6	12	33	47	4	18.5				
CITIZEN	GSW101	ATW-303-T09-D0620-Z06	○	6	6	20	35	3.2	15				
	MWS101/KSW101	ATW-304-T09-D1240-Z06	○	6	12	40	46	2.5	15.5				
	LSW101/BSW215/ LSW215315												
	LSW424	ATW-305-T09-D1245-Z06	○	6	12	45	46	9.5	18				
TORNOS	306101/307087	ATW-306-T09-D1240-Z06	○	6	12	40	57	3.5	15				
	417617	ATW-307-T09-D1250-Z06	○	6	12	50	67	3.5	15.4				
WTO	TN762004	ATW-308-T09-D1142-Z06	●	6	11	31.97	42	6.7	18.2				
	TN762006	ATW-309-T09-D2054-Z08	○	8	20	56.5	54	1.5	13.8				
TSUGAMI	3234 Y342	ATW-310-T09-D1252-Z06	○	6	12	52	65	8.7	17				
	3268 Y452	ATW-311-T09-D1252-Z06	○	6	12	52	52	10	10				
	3268 Y271	ATW-312-T09-D1252-Z06	○	6	12	52	54	6	19				
	3214 Y342	ATW-313-T09-D1650-Z06	○	6	16	50	62	8.5	20				
	3234 Y342	ATW-314-T09-D2052-Z06	○	6	20	52	65	8.7	17				
HANWHA	MADAULA	ATW-315-T09-D1245-Z06	○	6	12	45	56	8.5	15				



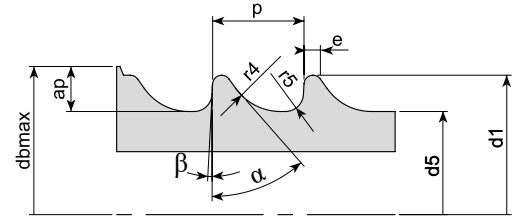
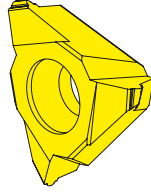

Uç Kodu Insert Code Код Пластины	Kalite Grade		Standart ISO5835	Uç Ölçüleri (mm) Insert Dimension (mm) Размеры (мм)									
	VK15U	VK15U01		P	e	d1	d5	r4	r5	α	β	ap	dbmax
T09.HA150.D12	○	○	HA1.5	0.5	0.1	1.35 to 1.5	1.0 to 1.1	0.30	0.1	35°	3°	4	9
T09.HA200.D12	○	○	HA2.0	0.6	0.1	1.85 to 2.0	1.2 to 1.3	0.40	0.1	35°	3°	4	9
T09.HA270.D12	●	●	HA2.7	1	0.1	2.55 to 2.7	1.75 to 1.9	0.60	0.2	35°	3°	4	9.5
T09.HA350.D12	●	●	HA3.5	1.25	0.1	3.35 to 3.5	2.25 to 2.4	0.80	0.2	35°	3°	4	10
T09.HA400.D12	○	○	HA4.0	1.5	0.1	3.85 to 4.0	2.75 to 2.9	0.80	0.2	35°	3°	4	10.5
T09.HA450.D12	●	●	HA4.5	1.75	0.1	4.35 to 4.5	2.85 to 3.0	1.00	0.3	35°	3°	4	11
T09.HA500.D12	○	○	HA5.0	1.75	0.1	4.85 to 5.0	3.35 to 3.5	1.00	0.3	35°	3°	4	11
T09.HB400.D12	○	○	HB4.0	1.75	0.1	3.85 to 4.0	1.75 to 1.9	0.80	0.3	25°	5°	4	9.5
T09.HB650.D12	○	○	HB6.5	2.75	0.2	6.35 to 6.5	2.85 to 3.0	1.20	0.8	25°	5°	4	11

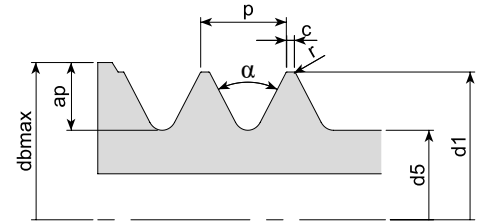
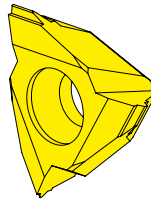
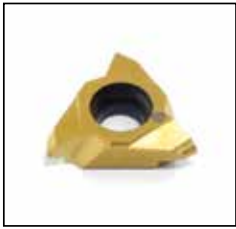

Uç Kodu Insert Code Код Пластины	Kalite Grade		Standart ISO9268	Uç Ölçüleri (mm) Insert Dimension (mm) Размеры (мм)									
	VK15U	VK15U01		P	e	d1	d5	α	c	r	ap	dbmax	
T09.HC290.D12	○	○	HC2.9	1.06	0.1	2.79 to 2.90	2.03 to 2.18	60°	0.1	0.01	4	10.5	
T09.HC350.D12	○	○	HC3.5	1.27	0.1	3.43 to 3.53	2.51 to 2.64	60°	0.1	0.01	4	11	
T09.HC390.D12	○	○	HC3.9	1.27	0.1	3.78 to 3.91	2.77 to 2.92	60°	0.1	0.01	4	11.5	
T09.HC420.D12	○	○	HC4.2	1.27	0.1	4.09 to 4.22	2.95 to 3.25	60°	0.1	0.01	4	12	

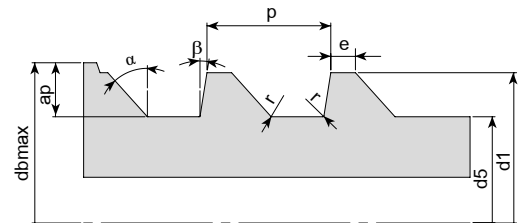
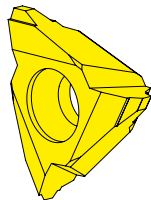
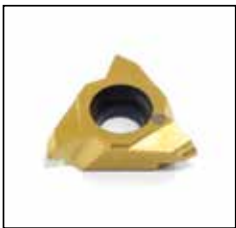

Uç Kodu Insert Code Код Пластины	Kalite Grade		Standart ISO9268	Uç Ölçüleri (mm) Insert Dimension (mm) Размеры (мм)									
	VK15U	VK15U01		P	e	d1	d5	e	r	α	β	ap	dbmax
T09.HD400.D12	○	○	HD4.0	1.59	0.1	3.97 to 4.03	2.89 to 2.95	0.1	0.01	45°	10°	4	11.5
T09.HD450.D12	○	○	HD4.5	2.18	0.1	4.47 to 4.53	2.89 to 2.95	0.1	0.01	45°	10°	4	12

Kesme başlangıç pozisyonu
Cutting Start Position
Стартовая позиция/Позиция

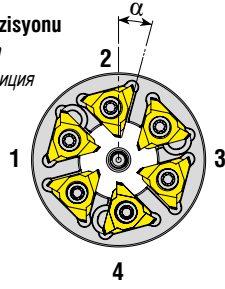

Y Eksen
Y Axis
Ось Y

İş parçası dönüş yönü

Turning Direction of Workpiece
Направление вращения заготовки

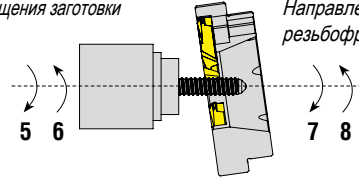

Whirling ünitesi dönüş yönü

Turning Direction of Whirling unit
Направление вращения
резьбофрезы

Makine Özellikleri Machine Specifications Данные об оборудовании		Malzeme Özellikleri Material Specifications Данные о детали	
Makine Üreticisi Machine Manufacturer Производитель станков		Malzeme (DIN, AISI v.b.) Material (DIN, AISI etc.) Обрабатываемый материал (DIN, AISI и т. д.)	
Makine Modeli Machine Model Модель станка		Ham Malzeme Çapı Raw Material Diameter Диаметр заготовки	
Canlı Takım Üreticisi Live Tool Manufacturer Производитель приводного блока		Diş Profili Thread Profile Профиль зуба	
Canlı Takım Tipi Live Tool Type Модель приводного блока		Profil Teknik Resmi Profile Technical Drawing Ссылка на чертёж	
Y - Eksen Y - Axis Ось Y	Var Exist Да <input type="checkbox"/>	Yok None Нет <input type="checkbox"/>	Hatve Pitch Шар
Yüksek Basıncılı Soğutma High Pressure Coolant Охлаждение под высоким давлением	Var Exist Да <input type="checkbox"/>	Yok None Нет <input type="checkbox"/>	Tek Ağz One Start Первый зуб
Kesme Başlangıç Pozisyonu Cutting Start Position Стартовая позиция	1 <input type="checkbox"/> 2 <input type="checkbox"/> 3 <input type="checkbox"/> 4 <input type="checkbox"/>		İki Ağz Two Starts Второй зуб
Whirling Ünitesi Dönüş Yönü Turning Direction of Whirling Unit Направление вращения резьбофрезы	5 <input type="checkbox"/> 6 <input type="checkbox"/>		Müşteri Adı / Customer Name / Покупатель:
İş Parçası Dönüş Yönü Turning Direction of Workpiece Направление вращения заготовки	7 <input type="checkbox"/> 8 <input type="checkbox"/>		Yetkili / Responsible Person / Должность:
α Açısı α Angle Угол α	Not: Bu açı ürün performansına etki ettiğinden bildirilmesi gerekmektedir. Aksi halinde ring tarafımıza gönderilmelidir. Note: This angle effects the performance of inserts. If doesn't known, tool body should be send to AKKO. Примечание: если угол установки пластин а неизвестен, то необходимо предоставить образец фрезы.		
Not / Note / Примечание:			



DIŞ TORNA TAKIMLARI
EXTERNAL TURNING TOOLHOLDERS
ДЕРЖАВКИ ДЛЯ НАРУЖНОГО ТОЧЕНИЯ





1 Sıkma Tipi / Method of Mounting of Insert / Способ монтажа вставки

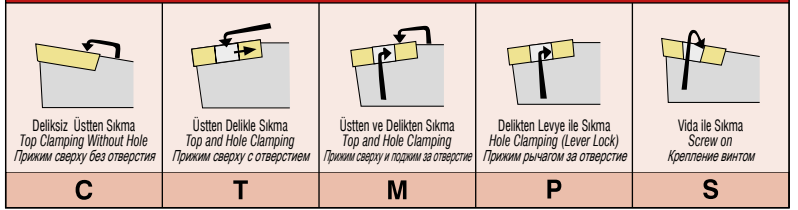

2 Uç Tipi / Type of Insert / Форма пластины

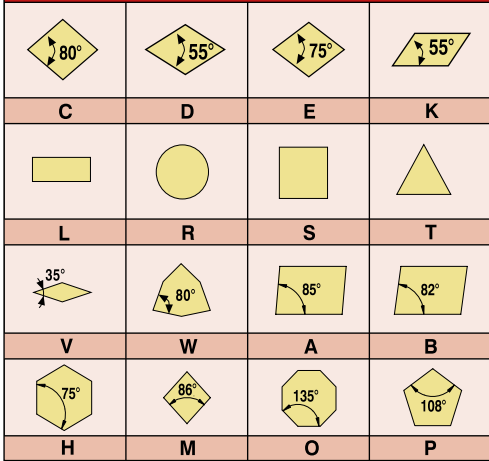

3 Yanaşma Açısı / Tool Holder Shape Bar Geometry / Угол направления

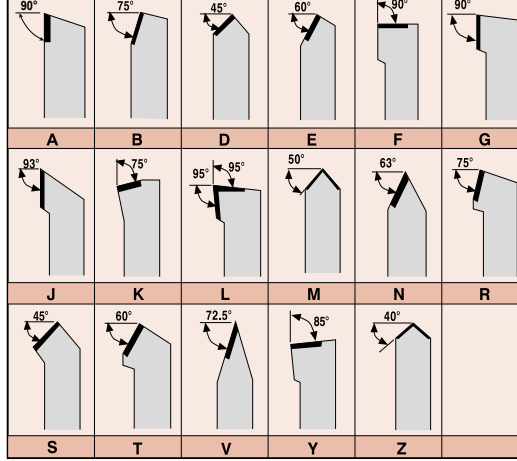

4 Serbest Uç Açısı / Insert Clearance Angle / Задний угол пластины

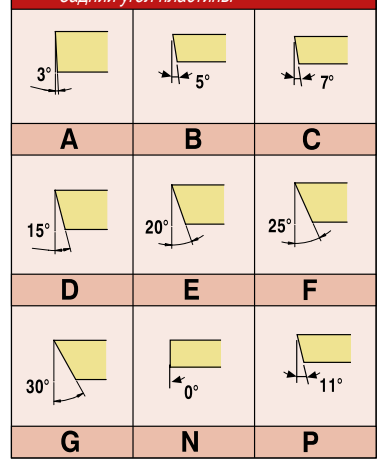

5 Kesme Yönü / Cutting Direction / Направление резания

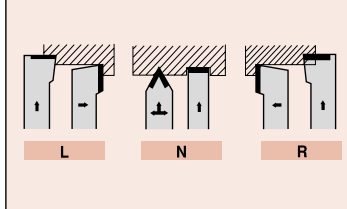

6 Kesme Kenar Yüksekliği / Cutting Edge Height / Высота режущей кромки

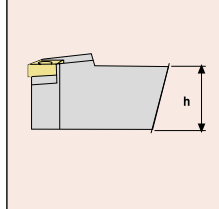

7 Şaft Genişliği / Shank Width / Ширина хвостовика

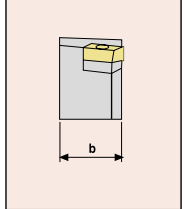

8 Şaft Boyu / Shank Length / Длина хвостовика

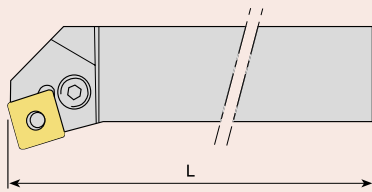

A - 32	H - 100	Q - 180	x-special
B - 40	J - 110	R - 200	
C - 50	K - 125	S - 250	
D - 60	L - 140	T - 300	
E - 70	M - 150	U - 350	
F - 80	N - 160	V - 400	
G - 90	P - 170	W - 450	

9 Kesme Kenar Uzunluğu / Cutting Edge Length / Длина режущей кромки

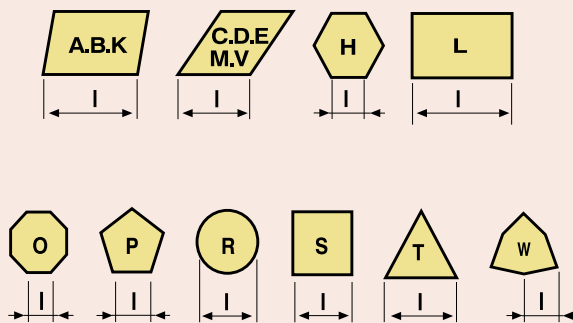

10 Baskı Pabucu / Wedge Clamp / Прижим

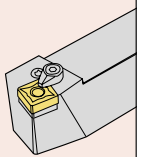



*konusulan
the spoken kalite...
quality...*

T-SİSTEM

T-SİSTEM DIŞ TORNA KATERLERİ

T-SYSTEM EXTERNAL TURNING TOOLHOLDERS

T-ТИП ДЕРЖАВКИ ДЛЯ НАРУЖНОГО ТОЧЕНИЯ



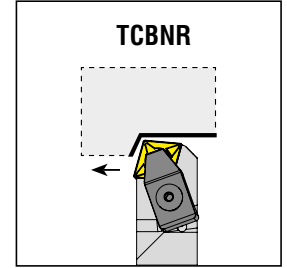
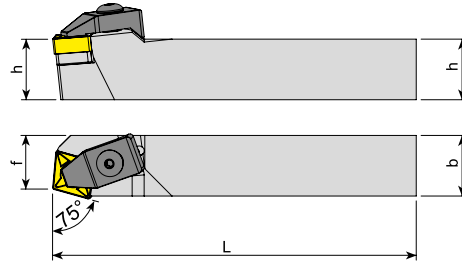

Takım Kodu Ordering Code Код для заказа	Stok Stock Наличие		Takım Ölçüleri (mm) Dimension (mm) Размеры (мм)				Kesici Uç Insert Пластина	Yedek Parçaları / Spare Parts / Запасные части						
	R	L	h	b	L	f		Baskı Pabucu Wedge Clamp Прижим	Pabuç Vidası Clamp Screw Винт прижима	Altlık Shim Опорная пластина	Altlık Vidası Shim Screw Винт опорной пластины	Sekman Ring Кольцо	Pul Stamp Шайба	Anahtar Allen Key Ключ
	●	●												
TCBNR/L 2525 M16	●	●	25	25	150	22	CNM. 1606..	ATK-04	AKV-19-M7x25	AACN-3-0002	AAV-05-M6x15	-	ABPL-02	AAL-05-4

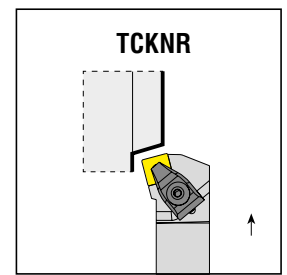
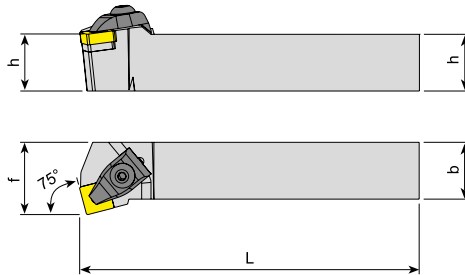

Takım Kodu Ordering Code Код для заказа	Stok Stock Наличие		Takım Ölçüleri (mm) Dimension (mm) Размеры (мм)				Kesici Uç Insert Пластина	Yedek Parçaları / Spare Parts / Запасные части						
	R	L	h	b	L	f		Baskı Pabucu Wedge Clamp Прижим	Pabuç Vidası Clamp Screw Винт прижима	Altlık Shim Опорная пластина	Altlık Vidası Shim Screw Винт опорной пластины	Sekman Ring Кольцо	Pul Stamp Шайба	Anahtar Allen Key Ключ
	●	●												
TCKNR/L 2020 K12	●	●	20	20	125	25	CNM. 1204..	ATK-02	AKV-30-M6x22	AACN-3-0001	AAV-02-M5x12	AS-01	ABPL-01	AAL-03-3
2525 M12	●	●	25	25	150	32								
3232 P12	●	●	32	32	170	40								
2525 M16	●	●	25	25	150	32	CNM. 1606..	ATK-04	AKV-19-M7x25	AACN-3-0002	AAV-05-M6x15	-	ABPL-02	AAL-05-4
3232 P16	●	●	32	32	170	40								

R: Sağ / Right / Правый L: Sol/Left / Левый

● Stokta / In Stock / В наличии ○ Stokta Yok / Non Stock Item / Нет в наличии

Sipariş Örneği/Ordering Example/Образец заказа

1 ad./pcs./шт TCBNR 2525 M16

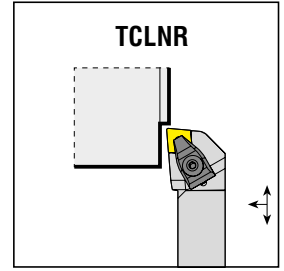
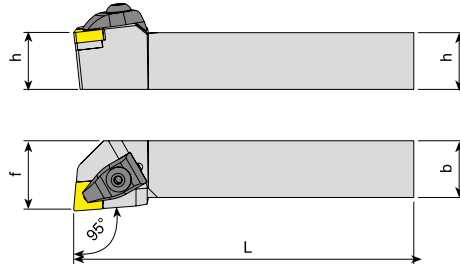
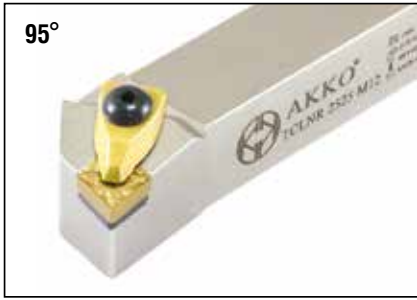

Takım Kodu Ordering Code Код для заказа	Stok Stock Наличие		Takım Ölçüleri (mm) Dimension (mm) Размеры (мм)				Kesici Uç Insert Пластина	Yedek Parçaları / Spare Parts / Запасные части								
	R	L	h	b	L	f		Baskı Pabucu Wedge Clamp Прижим	Pabuç Vidası Clamp Screw Винт прижима	Altlık Shim Опорная пластина	Altlık Vidası Shim Screw Винт опорной пластины	Sekman Ring Кольцо	Pul Stamp Шайба	Anahtar Allen Key Ключ		
TCLNR/L 2020 K12	●	●	20	20	125	25	CNM. 1204..									
2525 M12	●	●	25	25	150	32										
3232 P12	●	●	32	32	170	40										
4040 S12	●	●	40	40	250	50										
5050 S12	●	●	50	50	250	63										
2525 M16	●	●	25	25	150	32	CNM. 1606..									
3232 P16	●	●	32	32	170	40										

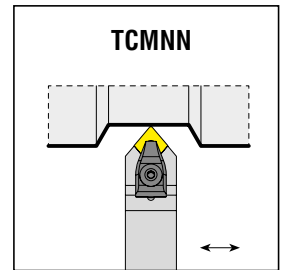
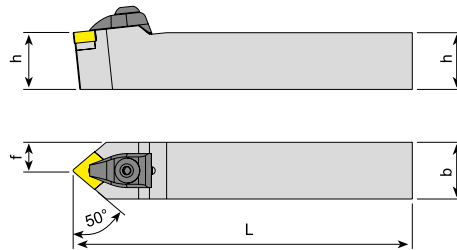

Takım Kodu Ordering Code Код для заказа	Stok Stock Наличие		Takım Ölçüleri (mm) Dimension (mm) Размеры (мм)				Kesici Uç Insert Пластина	Yedek Parçaları / Spare Parts / Запасные части								
	R	L	h	b	L	f		Baskı Pabucu Wedge Clamp Прижим	Pabuç Vidası Clamp Screw Винт прижима	Altlık Shim Опорная пластина	Altlık Vidası Shim Screw Винт опорной пластины	Sekman Ring Кольцо	Pul Stamp Шайба	Anahtar Allen Key Ключ		
TCMNN 1616 H12	●	○	16	16	100	8	CNM. 1204..									
2020 K12	●	○	20	20	125	10										
2525 M12	●	○	25	25	150	12.5										
3232 P12	●	○	32	32	170	16										
2525 M16	●	○	25	25	150	12.5										
3232 P16	●	○	32	32	170	16	CNM. 1606..									
4040 S16	○	○	40	40	250	20										

R: Sağ / Right / Правый L: Sol/Left/Левый

● Stokta / In Stock / В наличии ○ Stokta Yok / Non Stock Item / Нет в наличии

Sipariş Örneği/Ordering Example/Образец заказа

1 ad./pcs./шт TCLNR 2020 K12

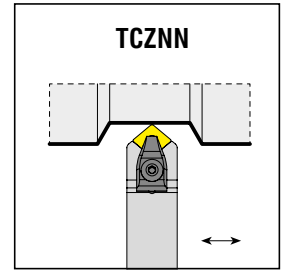
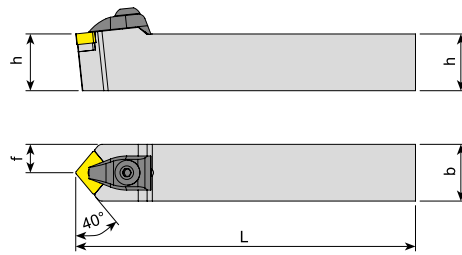

Takım Kodu Ordering Code Код для заказа	Stok Stock Наличие		Takım Ölçüleri (mm) Dimension (mm) Размеры (мм)				Kesici Uç Insert Пластина	Yedek Parçaları / Spare Parts / Запасные части														
	R	L	h	b	L	f		Baskı Pabucu Wedge Clamp Прижим	Pabuç Vidası Clamp Screw Винт прижима	Altlık Shim Опорная пластина	Altlık Vidası Shim Screw Винт опорной пластины	Sekman Ring Кольцо	Pul Stamp Шайба	Anahtar Allen Key Ключ								
TCZNN 2020 K12	●		20	20	125	10																
2525 M12	●		25	25	150	12.5									CNM. 1204..	ATK-02	AKV-30-M6x22	AACN-3-0001	AAV-02-M5x12	AS-01	ABPL-01	AAL-03-3
3232 P12	●		32	32	170	16																
2525 M16	●		25	25	150	12.5	CNM. 1606..	ATK-04	AKV-19-M7x25	AACN-3-0002	AAV-05-M6x15	-	ABPL-02	AAL-05-4								
3232 P16	●		32	32	170	16																

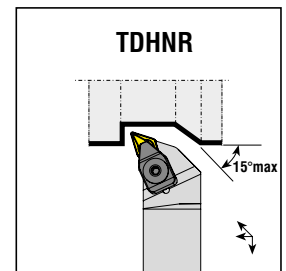
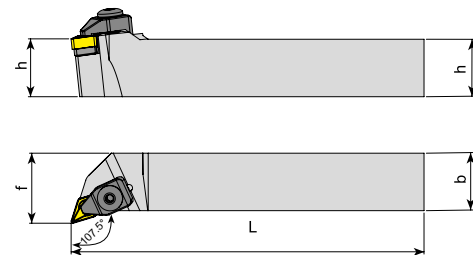

Takım Kodu Ordering Code Код для заказа	Stok Stock Наличие		Takım Ölçüleri (mm) Dimension (mm) Размеры (мм)				Kesici Uç Insert Пластина	Yedek Parçaları / Spare Parts / Запасные части						
	R	L	h	b	L	f		Baskı Pabucu Wedge Clamp Прижим	Pabuç Vidası Clamp Screw Винт прижима	Altlık Shim Опорная пластина	Altlık Vidası Shim Screw Винт опорной пластины	Sekman Ring Кольцо	Pul Stamp Шайба	Anahtar Allen Key Ключ
TDHNR/L 2525 M11	○	●	25	25	150	31								
2020 K15	●	●	20	20	125	25								
2525 M15	●	●	25	25	150	32	DNM. 1506..	ATK-02	AKV-30-M6x22	AADN-3-0001	AAV-02-M5x12	AS-01	ABPL-01	AAL-03-3
3232 P15	●	●	32	32	170	40								

R: Sağ / Right / Правый L: Sol/Left/Левый
● Stokta / In Stock / В наличии ○ Stokta Yok / Non Stock Item / Нет в наличии

Sipariş Örneği/Ordering Example/Образец заказа
1 ad./pcs./шт TCZNN 2020 K12

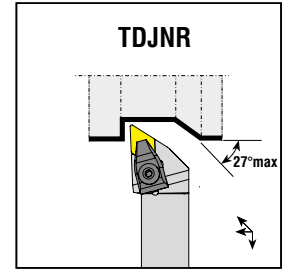
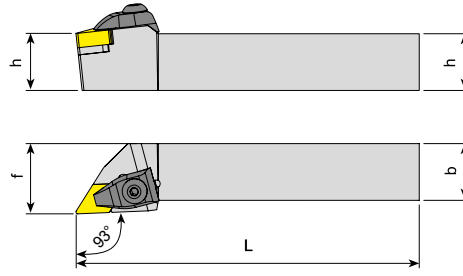
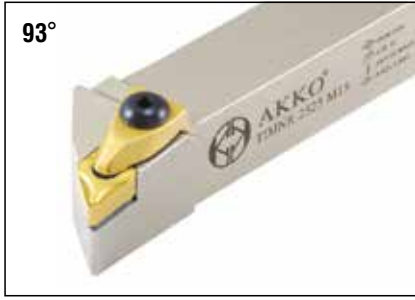

Takım Kodu Ordering Code Код для заказа	Stok Stock Наличие		Takım Ölçüleri (mm) Dimension (mm) Размеры (мм)				Kesici Uç Insert Пластина	Yedek Parçaları / Spare Parts / Запасные части						
	R	L	h	b	L	f		Baskı Pabucu Wedge Clamp Прижим	Pabuç Vidası Clamp Screw Винт прижима	Altılık Shim Отпорная пластина	Altılık Vidası Shim Screw Винт отпорной пластины	Sekman Ring Кольцо	Pul Stamp Шайба	Anahtar Allen Key Ключ
TDJNR/L 1616 H11	●	●	16	16	100	20	DNM. 1104..					-		
2020 K11	●	●	20	20	125	25								
2525 M11	●	●	25	25	150	32								
2020 K15	●	●	20	20	125	25	DNM. 1506..					AS-01	ABPL-01	AAL-03-3
2525 M15	●	●	25	25	150	32								
3232 P15	●	●	32	32	170	40								
4040 S15	●	●	40	40	250	50								
5050 S15	○	○	50	50	250	63	DNM. 1504..					AS-01		
2020 K1504	●	●	20	20	125	25								
2525 M1504	●	●	25	25	150	32								
3232 P1504	●	●	32	32	170	40								
4040 S1504	●	●	40	40	250	50								

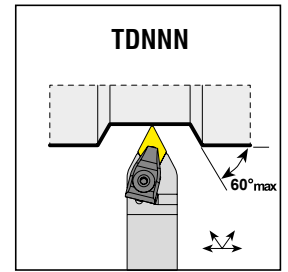
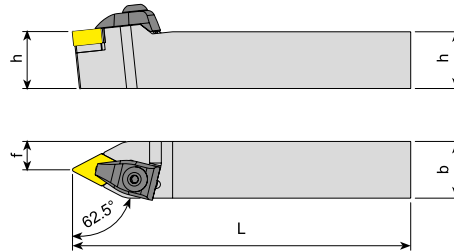
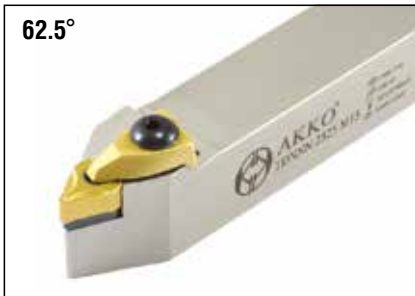

Takım Kodu Ordering Code Код для заказа	Stok Stock Наличие		Takım Ölçüleri (mm) Dimension (mm) Размеры (мм)				Kesici Uç Insert Пластина	Yedek Parçaları / Spare Parts / Запасные части						
	R	L	h	b	L	f		Baskı Pabucu Wedge Clamp Прижим	Pabuç Vidası Clamp Screw Винт прижима	Altılık Shim Отпорная пластина	Altılık Vidası Shim Screw Винт отпорной пластины	Sekman Ring Кольцо	Pul Stamp Шайба	Anahtar Allen Key Ключ
TDNNN 1616 H11	●	●	16	16	100	8	DNM. 1104..					-		
2020 K11	●	●	20	20	125	10								
2525 M11	●	●	25	25	150	12.5								
2020 K15	●	●	20	20	125	10	DNM. 1506..					AS-01	ABPL-01	AAL-03-3
2525 M15	●	●	25	25	150	12.5								
3232 P15	●	●	32	32	170	16								
4040 S15	○	○	40	40	250	20								
5050 S15	○	○	50	50	250	25								

R: Sağ / Right / Правый L: Sol/Left/Левый

● Stokta / In Stock / В наличии ○ Stokta Yok / Non Stock Item / Нет в наличии

Sipariş Örneği/Ordering Example/Образец заказа

1 ad./pcs./шт TDJNR 1616 H11

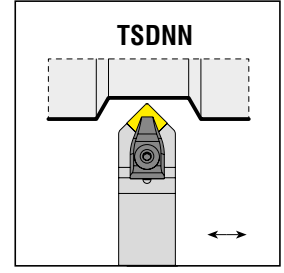
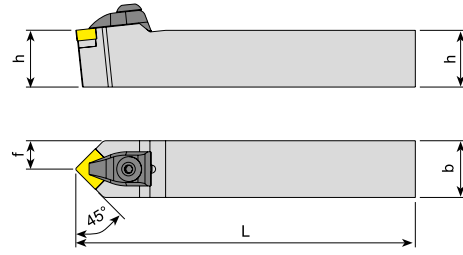

Takım Kodu Ordering Code Код для заказа	Stok Stock Наличие		Takım Ölçüleri (mm) Dimension (mm) Размеры (мм)				Kesici Uç Insert Пластина	Yedek Parçaları / Spare Parts / Запасные части						
	R	L	h	b	L	f		Baskı Pabucu Wedge Clamp Прижим	Pabuç Vidası Clamp Screw Винт прижима	Altılık Shim Опорная пластина	Altılık Vidası Shim Screw Винт опорной пластины	Sekman Ring Кольцо	Pul Stamp Шайба	Anahtar Allen Key Ключ
TSDNN 1616 H12	●		16	16	100	8	SNM. 1204..							
2020 K12	●		20	20	125	10								
2525 M12	●		25	25	150	12.5								
3232 P12	●		32	32	170	16								
2525 M15	○		25	25	150	12.5	SNM. 1506..							
3232 P15	○		32	32	170	16								
4040 S15	○		40	40	250	20								

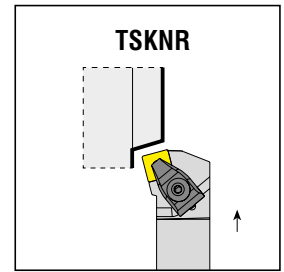
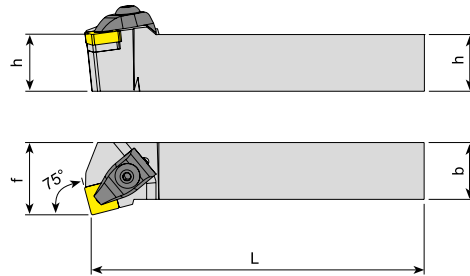

Takım Kodu Ordering Code Код для заказа	Stok Stock Наличие		Takım Ölçüleri (mm) Dimension (mm) Размеры (мм)				Kesici Uç Insert Пластина	Yedek Parçaları / Spare Parts / Запасные части						
	R	L	h	b	L	f		Baskı Pabucu Wedge Clamp Прижим	Pabuç Vidası Clamp Screw Винт прижима	Altılık Shim Опорная пластина	Altılık Vidası Shim Screw Винт опорной пластины	Sekman Ring Кольцо	Pul Stamp Шайба	Anahtar Allen Key Ключ
TSKNR/L 2020 K12	●	●	20	20	125	25	SNM. 1204..							
2525 M12	●	●	25	25	150	32								
3232 P12	●	●	32	32	170	40								
3232 P15	●	●	32	32	170	40	SNM. 1506..							

R: Sağ / Right / Правый L: Sol/Left/Левый

● Stokta / In Stock / В наличии ○ Stokta Yok / Non Stock Item / Нет в наличии

Sipariş Örneği/Ordering Example/Образец заказа

1 ad./pcs./шт TSDNN 1616 H12

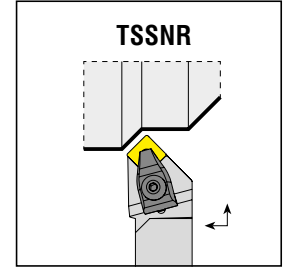
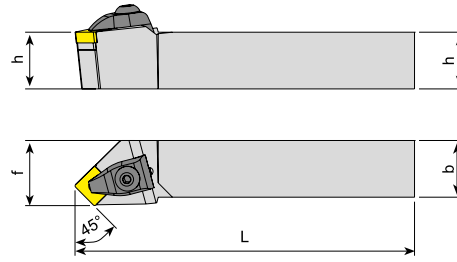

Takım Kodu Ordering Code Код для заказа	Stok Stock Наличие		Takım Ölçüleri (mm) Dimension (mm) Размеры (мм)				Kesici Uç Insert Пластина	Baskı Pabucu Wedge Clamp Прижим	Pabuç Vidası Clamp Screw Винт прижима	Altlık Shim Опорная пластина	Altlık Vidası Shim Screw Винт опорной пластины	Sekman Ring Кольцо	Pul Stamp Шайба	Anahtar Allen Key Ключ								
	R	L	h	b	L	f																
TSSNR/L 2020 K12	●	●	20	20	125	25																
2525 M12	●	●	25	25	150	32									SNM. 1204..	ATK-02	AKV-30-M6x22	AASN-3-0004	AAV-02-M5x12	AS-01	ABPL-01	AAL-03-3
3232 P12	●	●	32	32	170	40																
2525 M15	●	●	25	25	150	32	SNM. 1506..	ATK-04	AKV-19-M7x25	AASN-3-0023	AAV-05-M6x15	-	ABPL-02	AAL-05-4								
3232 P15	●	●	32	32	170	40																

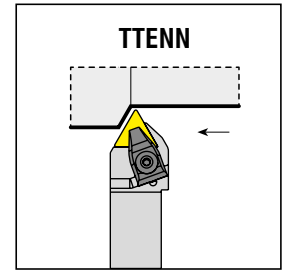
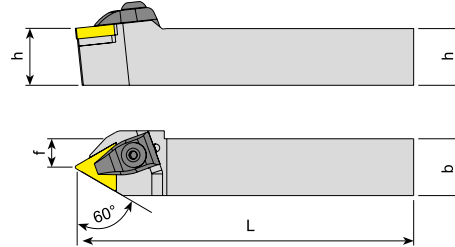

Takım Kodu Ordering Code Код для заказа	Stok Stock Наличие		Takım Ölçüleri (mm) Dimension (mm) Размеры (мм)				Kesici Uç Insert Пластина	Baskı Pabucu Wedge Clamp Прижим	Pabuç Vidası Clamp Screw Винт прижима	Altlık Shim Опорная пластина	Altlık Vidası Shim Screw Винт опорной пластины	Sekman Ring Кольцо	Pul Stamp Шайба	Anahtar Allen Key Ключ								
	R	L	h	b	L	f																
TTENN 2020 K16	●	○	20	20	125	10																
2525 M16	●	○	25	25	150	12.5									TNM. 1604..	ATK-01	AKV-01-M5x22	AATN-2-0002	AAV-03-M5x12	-	ABPL-01	AAL-03-3
3232 P16	●	○	32	32	170	16																
2525 M22	●	○	25	25	150	12.5	TNM. 2204..	ATK-02	AKV-30-M6x22	AATN-3-0015	AAV-02-M5x12	AS-01										
3232 P22	●	○	32	32	170	16																
4040 S22	○	○	40	40	250	20																

R: Sağ / Right / Правый L: Sol/Left/Левый
● Stokta / In Stock / В наличии ○ Stokta Yok / Non Stock Item / Нет в наличии

Sipariş Örneği/Ordering Example/Образец заказа
1 ad./pcs./шт TSSNR 2020 K12

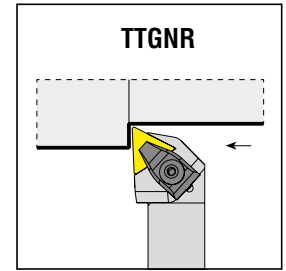
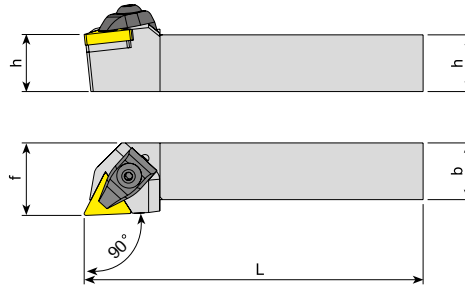

Takım Kodu Ordering Code Код для заказа	Stok Stock Наличие		Takım Ölçüleri (mm) Dimension (mm) Размеры (мм)				Kesici Uç Insert Пластина	Yedek Parçaları / Spare Parts / Запасные части												
	R	L	h	b	L	f		Baskı Pabucu Wedge Clamp Прижим	Pabuç Vidası Clamp Screw Винт прижима	Altlık Shim Опорная пластина	Altlık Vidası Shim Screw Винт опорной пластины	Sekman Ring Кольцо	Pul Stamp Шайба	Anahtar Allen Key Ключ						
TTGNR/L 2020 K16	●	●	20	20	125	25														
2525 M16	●	●	25	25	150	32									TNM. 1604..	ATK-01	AKV-01-M5x22	AATN-2-0002	AAV-03-M5x12	-
3232 P16	●	●	32	32	170	40									TNM. 2204..	ATK-02	AKV-30-M6x22	AATN-3-0015	AAV-02-M5x12	AS-01
2525 M22	●	●	25	25	150	32														
3232 P22	●	●	32	32	170	40														
4040 S22	●	○	40	40	250	50														

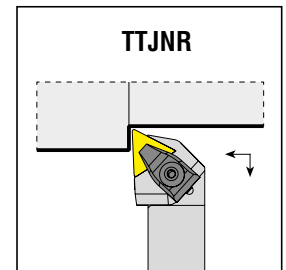
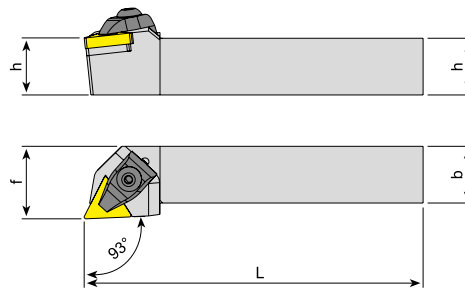
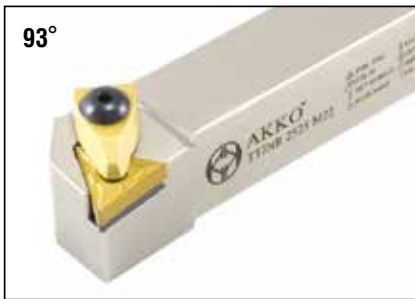

Takım Kodu Ordering Code Код для заказа	Stok Stock Наличие		Takım Ölçüleri (mm) Dimension (mm) Размеры (мм)				Kesici Uç Insert Пластина	Yedek Parçaları / Spare Parts / Запасные части												
	R	L	h	b	L	f		Baskı Pabucu Wedge Clamp Прижим	Pabuç Vidası Clamp Screw Винт прижима	Altlık Shim Опорная пластина	Altlık Vidası Shim Screw Винт опорной пластины	Sekman Ring Кольцо	Pul Stamp Шайба	Anahtar Allen Key Ключ						
TTJNR/L 2020 K16	●	●	20	20	125	25														
2525 M16	●	●	25	25	150	32									TNM. 1604..	ATK-01	AKV-01-M5x22	AATN-2-0002	AAV-03-M5x12	-
3232 P16	●	●	32	32	170	40									TNM. 2204..	ATK-02	AKV-30-M6x22	AATN-3-0015	AAV-02-M5x12	AS-01
2525 M22	●	●	25	25	150	32														
3232 P22	●	●	32	32	170	40														
4040 S22	○	○	40	40	250	50														

R: Sağ / Right / Правый L: Sol/Left/ Левый

● Stokta / In Stock / В наличии ○ Stokta Yok / Non Stock Item / Нет в наличии

Sipariş Örneği/Ordering Example/Образец заказа

1 ad./pcs./шт TTGNR 2020 K16

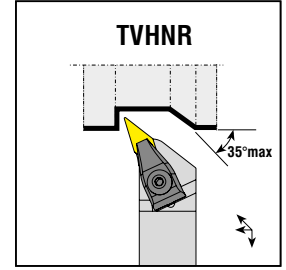
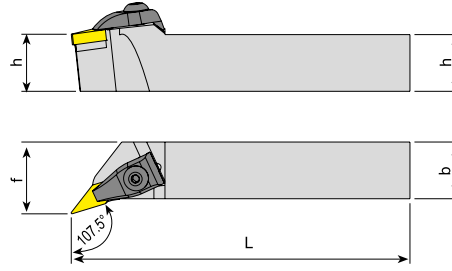

Takım Kodu Ordering Code Код для заказа	Stok Stock Наличие		Takım Ölçüleri (mm) Dimension (mm) Размеры (мм)				Kesici Uç Insert Пластина	Yedek Parçaları / Spare Parts / Запасные части							
	R	L	h	b	L	f		Baskı Pabucu Wedge Clamp Прижим	Pabuç Vidası Clamp Screw Винт прижима	Altık Shim Опорная пластина	Altık Vidası Shim Screw Винт опорной пластины	Sekman Ring Кольцо	Pul Stamp Шайба	Anahtar Allen Key Ключ	
TVHNR/L 2020 K16	●	●	20	20	125	25	VNM. 1604..								
2525 M16	●	●	25	25	150	32									
3232 P16	●	●	32	32	170	40									

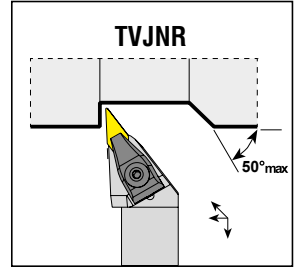
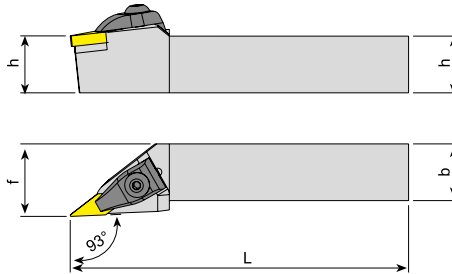

Takım Kodu Ordering Code Код для заказа	Stok Stock Наличие		Takım Ölçüleri (mm) Dimension (mm) Размеры (мм)				Kesici Uç Insert Пластина	Yedek Parçaları / Spare Parts / Запасные части							
	R	L	h	b	L	f		Baskı Pabucu Wedge Clamp Прижим	Pabuç Vidası Clamp Screw Винт прижима	Altık Shim Опорная пластина	Altık Vidası Shim Screw Винт опорной пластины	Sekman Ring Кольцо	Pul Stamp Шайба	Anahtar Allen Key Ключ	
TVJNR/L 2020 K16	●	●	20	20	125	25	VNM. 1604..								
2525 M16	●	●	25	25	150	32									
3232 P16	●	●	32	32	170	40									

R: Sağ / Right / Правый L: Sol/Left/Левый
● Stokta / In Stock / В наличии ○ Stokta Yok / Non Stock Item / Нет в наличии

Sipariş Örneği/Ordering Example/Образец заказа
1 ad./pcs./шт TVHNR 2020 K16

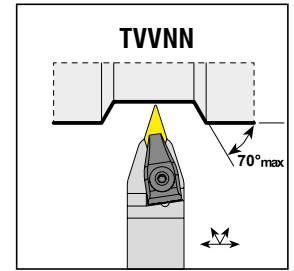
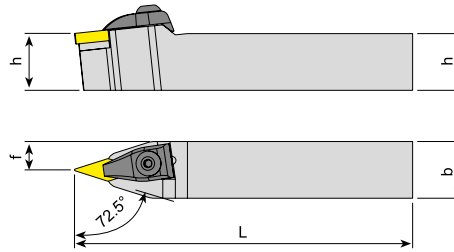

Takım Kodu Ordering Code Код для заказа	Stok Stock Наличие	Takım Ölçüleri (mm) Dimension (mm) Размеры (мм)				Kesici Uç Insert Пластина	Yedek Parçaları / Spare Parts / Запасные части						
		h	b	L	f		Baskı Pabucu Wedge Clamp Прижим	Pabuç Vidası Clamp Screw Винт прижима	Altlık Shim Опорная пластина	Altlık Vidası Shim Screw Винт опорной пластины	Sekman Ring Кольцо	Pul Stamp Шайба	Anahtar Allen Key Ключ
TVVNN 2020 K16	●	20	20	125	10	VNM. 1604..							
2525 M16	●	25	25	150	12.5								
3232 P16	●	32	32	170	16								

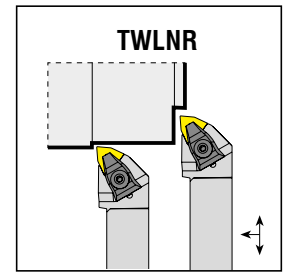
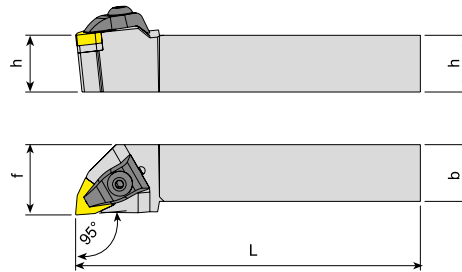

Takım Kodu Ordering Code Код для заказа	Stok Stock Наличие		Takım Ölçüleri (mm) Dimension (mm) Размеры (мм)				Kesici Uç Insert Пластина	Yedek Parçaları / Spare Parts / Запасные части						
	R	L	h	b	L	f		Baskı Pabucu Wedge Clamp Прижим	Pabuç Vidası Clamp Screw Винт прижима	Altlık Shim Опорная пластина	Altlık Vidası Shim Screw Винт опорной пластины	Sekman Ring Кольцо	Pul Stamp Шайба	Anahtar Allen Key Ключ
TWLNR/L 1616 H06	●	●	16	16	100	20	WNM. 0604..							
2020 K06	●	●	20	20	125	25								
2525 M06	●	●	25	25	150	32								
2020 K08	●	●	20	20	125	25	WNM. 0804..							
2525 M08	●	●	25	25	150	32								
3232 P08	●	●	32	32	170	40								
4040 S08	●	●	40	40	250	50								
5050 S08	○	○	50	50	250	63								

R: Sağ / Right / Правый L: Sol/Left/Левый

● Stokta / In Stock / В наличии ○ Stokta Yok / Non Stock Item / Нет в наличии

Sipariş Örneği/Ordering Example/Образец заказа

1 ad./pcs./шт TVVNN 2020 K16



*konusulan
the spoken kalite...
quality...*

M-SİSTEM

M-SİSTEM DIŞ TORNA KATERLERİ

M-SYSTEM EXTERNAL TURNING TOOLHOLDERS

М-ТИП ДЕРЖАВКИ ДЛЯ НАРУЖНОГО ТОЧЕНИЯ



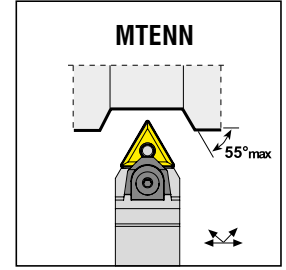
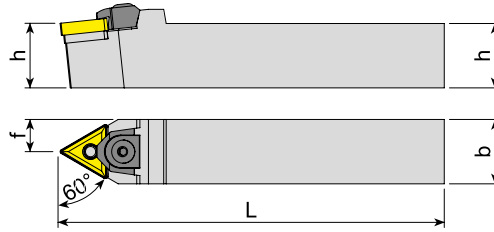

Yedek Parçaları / Spare Parts / Запасные части

Takım Kodu Ordering Code Код для заказа	Stok Stock Наличие		Takım Ölçüleri (mm) Dimension (mm) Размеры (мм)				Kesici Uç Insert Пластина	Baskı Pabuçu Wedge Clamp Прижим	Pabuç Vidası Clamp Screw Винт прижима	Altlık Shim Опорная пластина	Pim Pin Штифт	Sekman Ring Кольцо	Pul Stamp Шайба	Anahtar Allen Key Ключ
	R	L	h	b	L	f								
MTENN 2020 K16	●		20	20	125	10	TNM. 1604..	AMK-04	AKV-30-M6x22	AATN-2-0002	APM-01	AS-01	ABPL-01	AAL-03-3
2525 M16	●		25	25	150	12.5								
3232 P16	●		32	32	170	16								
2525 M22	●		25	25	150	12.5	TNM. 2204..		AATN-3-0015	APM-02				
3232 P22	●		32	32	170	16								
4040 S22	●		40	40	250	20								

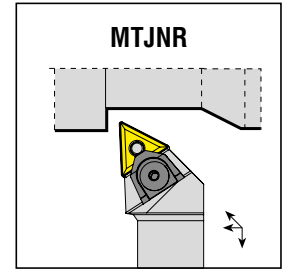
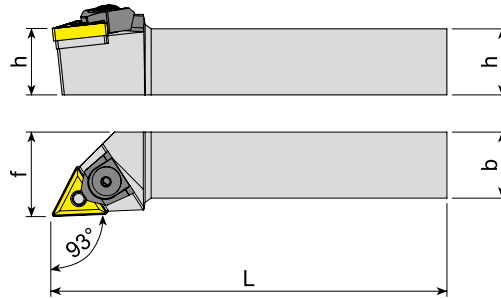
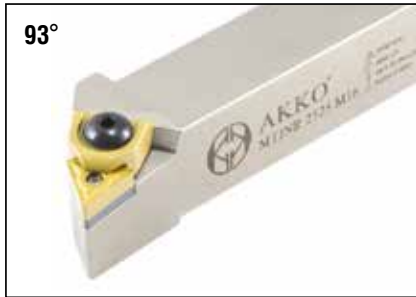

Yedek Parçaları / Spare Parts / Запасные части

Takım Kodu Ordering Code Код для заказа	Stok Stock Наличие		Takım Ölçüleri (mm) Dimension (mm) Размеры (мм)				Kesici Uç Insert Пластина	Baskı Pabuçu Wedge Clamp Прижим	Pabuç Vidası Clamp Screw Винт прижима	Altlık Shim Опорная пластина	Pim Pin Штифт	Sekman Ring Кольцо	Pul Stamp Шайба	Anahtar Allen Key Ключ
	R	L	h	b	L	f								
MTJNR/L 2020 K16	●	●	20	20	125	25	TNM. 1604..	AMK-04	AKV-30-M6x22	AATN-2-0002	APM-01	AS-01	ABPL-01	AAL-03-3
2525 M16	●		25	25	150	32								
3232 P16	●		32	32	170	40								
2525 M22	●		25	25	150	32	TNM. 2204..		AATN-3-0015	APM-02				
3232 P22	●		32	32	170	40								
4040 S22	●		40	40	250	50								

R: Sağ / Right / Правый L: Sol/Left/Левый

● Stokta / In Stock / В наличии ○ Stokta Yok / Non Stock Item / Нет в наличии

Sipariş Örneği/Ordering Example/Образец заказа

1 ad./pcs./шт MTJNR 2020 K16

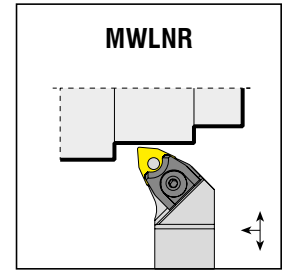
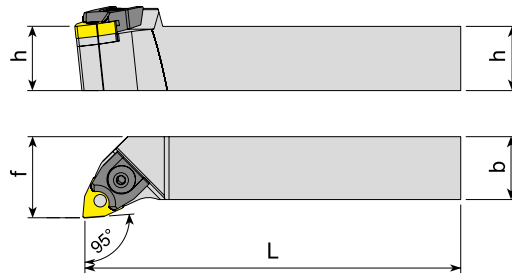

Takım Kodu Ordering Code Код для заказа	Stok Stock Наличие		Takım Ölçüleri (mm) Dimension (mm) Размеры (мм)				Kesici Uç Insert Пластина	Yedek Parçaları / Spare Parts / Запасные части													
	R	L	h	b	L	f		Baskı Pabuçu Wedge Clamp Прижим	Pabuç Vidası Clamp Screw Винт прижима	Altlık Shim Опорная пластина	Pim Pin Штифт	Sekman Ring Кольцо	Pul Stamp Шайба	Anahtar Allen Key Ключ							
MWLNR/L 1616 H06	●	●	16	16	100	20															
2020 K06	●	●	20	20	125	25									WNM. 0604..	AMK-01	AKV-04-M5x17	-	APM-08	-	-
2525 M06	●	●	25	25	150	32															
2020 K08	●	●	20	20	125	25															
2525 M08	●	●	25	25	150	32									WNM. 0804..	AMK-05	AKV-03-M6x22	AAWN-3-0001	APM-02	AS-01	ABPL-01
3232 P08	●	●	32	32	170	40															

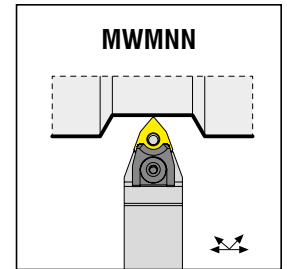
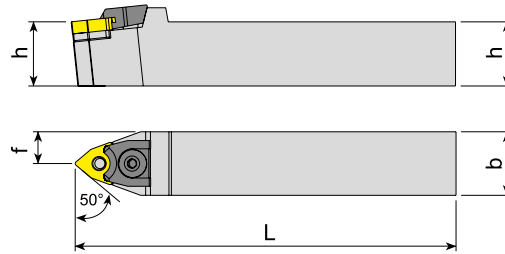

Takım Kodu Ordering Code Код для заказа	Stok Stock Наличие		Takım Ölçüleri (mm) Dimension (mm) Размеры (мм)				Kesici Uç Insert Пластина	Yedek Parçaları / Spare Parts / Запасные части													
	R	L	h	b	L	f		Baskı Pabuçu Wedge Clamp Прижим	Pabuç Vidası Clamp Screw Винт прижима	Altlık Shim Опорная пластина	Pim Pin Штифт	Sekman Ring Кольцо	Pul Stamp Шайба	Anahtar Allen Key Ключ							
MWMNN 1616 H06	●	●	16	16	100	8															
2020 K06	●	●	20	20	125	10									WNM. 0604..	AMK-01	AKV-04-M5x17	-	APM-08	-	-
2525 M06	●	●	25	25	150	12.5															
2020 K08	●	●	20	20	125	10															
2525 M08	●	●	25	25	150	12.5									WNM. 0804..	AMK-05	AKV-03-M6x22	AAWN-3-0001	APM-02	AS-01	ABPL-01
3232 P08	●	●	32	32	170	16															

R: Sağ / Right / Правый L: Sol/Left/Левый

● Stokta / In Stock / В наличии ○ Stokta Yok / Non Stock Item / Нет в наличии

Sipariş Örneği/Ordering Example/Образец заказа

1 ad./pcs./шт MWLNR 1616 H06

P-SİSTEM

P-SİSTEM DIŞ TORNA KATERLERİ

P-SYSTEM EXTERNAL TURNING TOOLHOLDERS

P-ТИП ДЕРЖАВКИ ДЛЯ НАРУЖНОГО ТОЧЕНИЯ

*konusulan
the spoken kalite...
quality...*



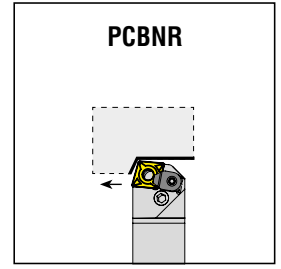
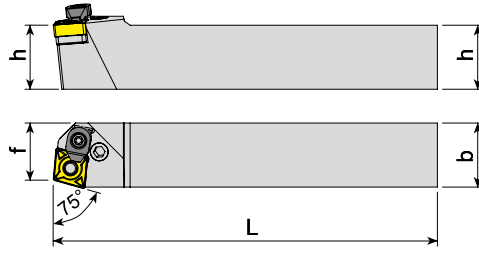

Takım Kodu Ordering Code Код для заказа	Stok Stock Наличие		Takım Ölçüleri (mm) Dimension (mm) Размеры (мм)				Kesici Uç Insert Пластина	Yedek Parçaları / Spare Parts / Запасные части						
	R	L	h	b	L	f		Levye Lever Рычаг	Levye Vidası Lever Screw Винт рычага	Altlık Shim Опорная пластина	Altlık Yay Shim Spring Втулка рычага	Baskı Parçası Wedge Clamp Прижим	Baskı Vidası Clamp Screw Зажимной винт	Anahtar Allen Key Ключ
PCBNR/L 2020 K12C	●	●	20	20	125	17.5								
2525 M12C	●	●	25	25	150	22.5	CNM. 1204..	APL-02	ALV-03-M8x19	AACN-3-0001	AAY-02	ACK-05	4015-M4x11	AAL-03-3
3232 P12C	●	●	32	32	170	29.5								
2525 M16C	●	●	25	25	150	22	CNM. 1606..	APL-04	ALV-04-M8x22	AACN-3-0002	AAY-03			
3232 P16C	●	●	32	32	170	27								
3232 P19C	●	●	32	32	170	27	CNM. 1906..	APL-05	ALV-05-M10x27	AACN-3-0003	AAY-04	ACK-09	AAV-05-M6x15	AAL-05-4
4040 S19C	●	●	40	40	250	37								
4040 S25C	●	●	40	40	250	37	CNM. 2509..	APL-06	ALV-06-M12x36	AACN-3-0008	AAY-05	ACK-04	AKV-16-M6x16	AAL-07-5
5050 S25C	○	○	50	50	250	47								

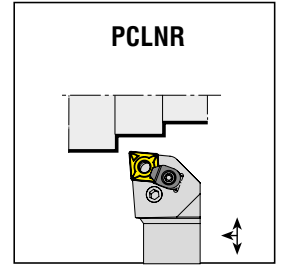
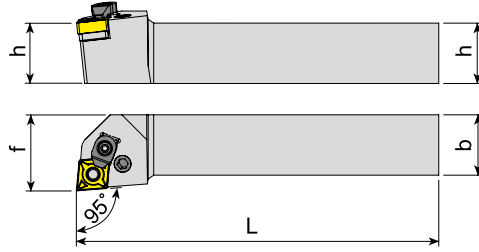
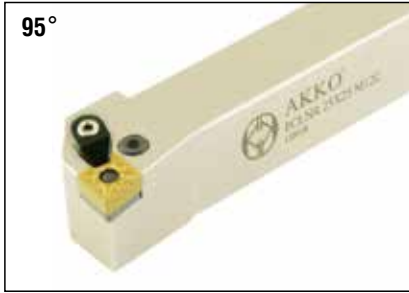

Takım Kodu Ordering Code Код для заказа	Stok Stock Наличие		Takım Ölçüleri (mm) Dimension (mm) Размеры (мм)				Kesici Uç Insert Пластина	Yedek Parçaları / Spare Parts / Запасные части						
	R	L	h	b	L	f		Levye Lever Рычаг	Levye Vidası Lever Screw Винт рычага	Altlık Shim Опорная пластина	Altlık Yay Shim Spring Втулка рычага	Baskı Parçası Wedge Clamp Прижим	Baskı Vidası Clamp Screw Зажимной винт	Anahtar Allen Key Ключ
PCLNR/L 1616 H09	●	●	16	16	100	20								
2020 K09	●	●	20	20	125	25	CNM. 0903..	APL-01	ALV-02-M6x17	AACN-2-0002	AAY-01	-	-	AAL-02-2.5
2525 M09	●	●	25	25	150	32								
1616 H12	●	●	16	16	100	20	CNM. 1204..	APL-02	ALV-03-M8x19	AACN-3-0001	AAY-02	ACK-05	4015-M4x11	AAL-03-3
2020 K12C	●	●	20	20	125	25								
2525 M12C	●	●	25	25	150	32	CNM. 1606..	APL-04	ALV-04-M8x22	AACN-3-0002	AAY-03			
3232 P12C	●	●	32	32	170	40								
2525 M16C	●	●	25	25	150	32	CNM. 1906..	APL-05	ALV-05-M10x27	AACN-3-0003	AAY-04	ACK-09	AAV-05-M6x15	AAL-05-4
3232 P16C	●	●	32	32	170	40								
2525 M19C	●	●	25	25	150	32	CNM. 2509..	APL-06	ALV-06-M12x36	AACN-3-0008	AAY-05	ACK-04	AKV-16-M6x16	AAL-07-5
3232 P19C	●	●	32	32	170	40								
4040 S19C	●	●	40	40	250	50								
4040 S25C	●	●	40	40	250	50								
5050 S25C	●	●	50	50	250	60								

R: Sağ / Right / Правый L: Sol/Left/Левый

● Stokta / In Stock / В наличии ○ Stokta Yok / Non Stock Item / Нет в наличии

Sipariş Örneği/Ordering Example/Образец заказа

1 ad./pcs./шт PCBNR 2020 K12C

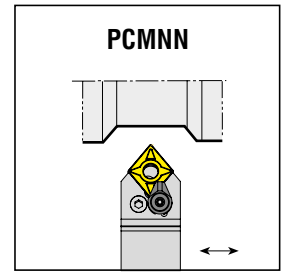
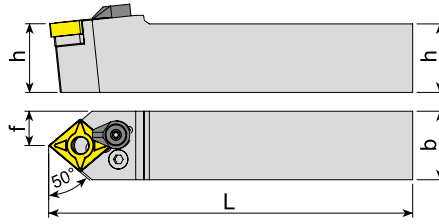

Takım Kodu Ordering Code Код для заказа	Stok Stock Наличие		Takım Ölçüleri (mm) Dimension (mm) Размеры (мм)				Kesici Uç Insert Пластина	Yedek Parçaları / Spare Parts / Запасные части						
	R	L	h	b	L	f		Levyé Lever Рычаг	Levyé Vidası Lever Screw Винт рычага	Altılık Shim Опорная пластина	Altılık Yay Shim Spring Втулка рычага	Baskı Parçası Wedge Clamp Прижим	Baskı Vidası Clamp Screw Зажимной винт	Anahtar Allen Key Ключ
PCMNN 2020 K12C	●		20	20	125	10	CNM. 1204..							
2525 M12C	●		25	25	150	12.5								
3232 P12C	○		32	32	170	16								
2525 M16C	○		25	25	150	12.5	CNM. 1606..							
3232 P16C	○		32	32	170	16								
3232 P19C	●		32	32	170	16								
4040 S19C	●		40	40	250	20	CNM. 1906..							
5050 S19C	○		50	50	250	25								
4040 S25C	●		40	40	250	20	CNM. 2509..							

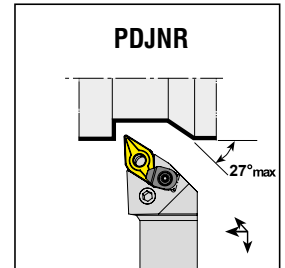
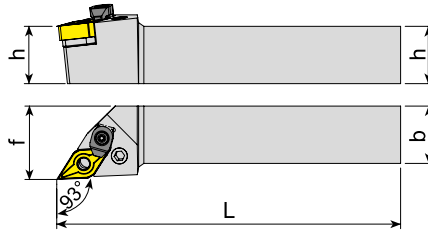

Takım Kodu Ordering Code Код для заказа	Stok Stock Наличие		Takım Ölçüleri (mm) Dimension (mm) Размеры (мм)				Kesici Uç Insert Пластина	Yedek Parçaları / Spare Parts / Запасные части						
	R	L	h	b	L	f		Levyé Lever Рычаг	Levyé Vidası Lever Screw Винт рычага	Altılık Shim Опорная пластина	Altılık Yay Shim Spring Втулка рычага	Baskı Parçası Wedge Clamp Прижим	Baskı Vidası Clamp Screw Зажимной винт	Anahtar Allen Key Ключ
PDJNR/L 1616 H11	●	●	16	16	100	20	DNM. 1104..							
2020 K11	●	●	20	20	125	25								
2525 M11	●	●	25	25	150	32								
2020 K15C	●	●	20	20	125	25	DNM. 1506..							
2525 M15C	●	●	25	25	150	32								
3232 P15C	●	●	32	32	170	40								
4040 S15C	●	●	40	40	250	50								

R: Sağ / Right / Правый L: Sol/Left/Левый

● Stokta / In Stock / В наличии ○ Stokta Yok / Non Stock Item / Нет в наличии

Sipariş Örneği/Ordering Example/Образец заказа
1 ad./pcs./шт PCMNN 2020 K12C

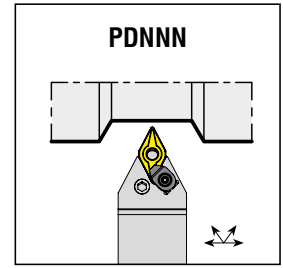
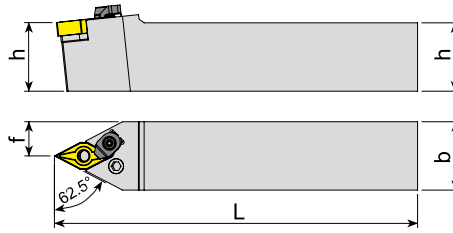

Takım Kodu Ordering Code Код для заказа	Stok Stock Наличие		Takım Ölçüleri (mm) Dimension (mm) Размеры (мм)				Kesici Uç Insert Пластина	Yedek Parçaları / Spare Parts / Запасные части							
	R	L	h	b	L	f		Levyeye Lever Рычаг	Levyeye Vidası Lever Screw Винт рычага	Altılık Shim Опорная пластина	Altılık Yayı Shim Spring Втулка рычага	Baskı Parçası Wedge Clamp Прижим	Baskı Vidası Clamp Screw Зажимной винт	Anahtar Allen Key Ключ	
PDNNN 1616 H11	●		16	16	100	8						-	-	AAL-02-2.5	
2020 K11	●		20	20	125	10									DNM. 1104..
2525 M11	●		25	25	150	12.5									
2020 K15C	●		20	20	125	10						ACK-05	4015-M4x11	AAL-03-3	
2525 M15C	●		25	25	150	12.5									DNM. 1506..
3232 P15C	●		32	32	170	16									

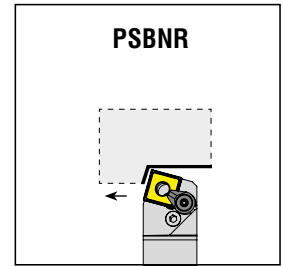
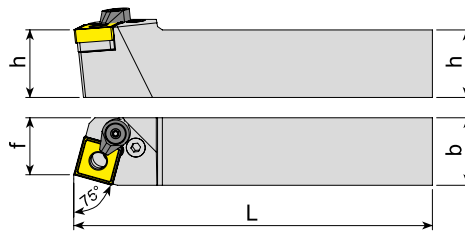
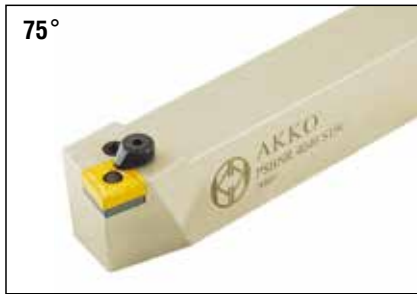

Takım Kodu Ordering Code Код для заказа	Stok Stock Наличие		Takım Ölçüleri (mm) Dimension (mm) Размеры (мм)				Kesici Uç Insert Пластина	Yedek Parçaları / Spare Parts / Запасные части							
	R	L	h	b	L	f		Levyeye Lever Рычаг	Levyeye Vidası Lever Screw Винт рычага	Altılık Shim Опорная пластина	Altılık Yayı Shim Spring Втулка рычага	Baskı Parçası Wedge Clamp Прижим	Baskı Vidası Clamp Screw Зажимной винт	Anahtar Allen Key Ключ	
PSBNNR/L 1616 H09	●	●	16	16	100	13						-	-	AAL-02-2.5	
2020 K09	○	○	20	20	125	17									SNM. 0903..
2020 K12	●	●	20	20	125	17									
2525 M12C	●	●	25	25	150	22						ACK-05	4015-M4x11	AAL-03-3	
3232 P12C	●	●	32	32	170	27									SNM. 1204..
2525 M15	●	●	25	25	150	22									
3232 P15C	●	●	32	32	170	27						-	-	AAL-05-4	
3232 P19C	●	●	32	32	170	27									SNM. 1506..
4040 S19C	●	●	40	40	250	35									
4040 S25C	●	●	40	40	250	35						ACK-09	AAV-05-M6x15	AAL-05-4	
5050 S25C	○	○	50	50	250	43									SNM. 1906..
												ACK-04	AKV-16-M6x16	AAL-07-5	
															SNM. 2509..

R: Sağ / Right / Правый L: Sol/Left/Левый

● Stokta / In Stock / В наличии ○ Stokta Yok / Non Stock Item / Нет в наличии

Sipariş Örneği/Ordering Example/Образец заказа

1 ad./pcs./шт PDNNN 1616 H11

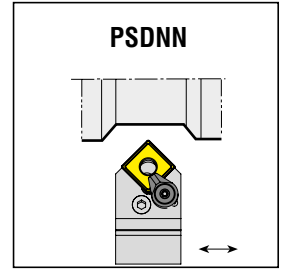
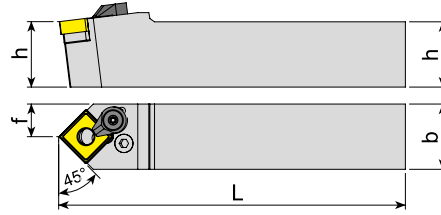

Takım Kodu Ordering Code Код для заказа	Stok Stock Наличие		Takım Ölçüleri (mm) Dimension (mm) Размеры (мм)				Kesici Uç Insert Пластина	Yedek Parçaları / Spare Parts / Запасные части						
	R	L	h	b	L	f		Levyeye Lever Рычаг	Levyeye Vidası Lever Screw Винт рычага	Altılık Shim Опорная пластина	Altılık Yayı Shim Spring Втулка рычага	Baskı Parçası Wedge Clamp Прижим	Baskı Vidası Clamp Screw Зажимной винт	Anahtar Allen Key Ключ
PSDNN 1616 H09	●		16	16	100	8		APL-01	ALV-02-M6x17	AASN-2-0002	AAY-01	-	-	AAL-02-2.5
2020 K12C	●		20	20	125	10								
2525 M12C	●		25	25	150	12.5	SNM. 1204..	APL-02	ALV-03-M8x19	AASN-3-0004	AAY-02	ACK-05	4015-M4x11	AAL-03-3
3232 P12C	●		32	32	170	16								
2020 K15C	○		20	20	125	10	SNM. 1506..	APL-04	ALV-04-M8x22	AASN-3-0023	AAY-03			
2525 M15C	●		25	25	150	12.5								
3232 P19C	●		32	32	170	16								
4040 S19C	○		40	40	250	20	SNM. 1906..	APL-05	ALV-05-M10x27	AASN-3-0005	AAY-04	ACK-09	AAV-05-M6x15	AAL-05-4
5050 S19C	○		50	50	250	25								
4040 S25C	●		40	40	250	20	SNM. 2509..	APL-06	ALV-06-M12x36	AASN-3-0020	AAY-05	ACK-04	AKV-16-M6x16	AAL-07-5
5050 S25C	○		50	50	250	25								

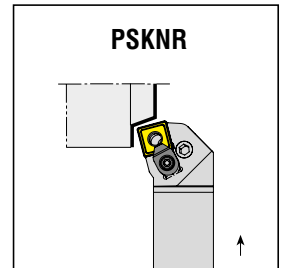
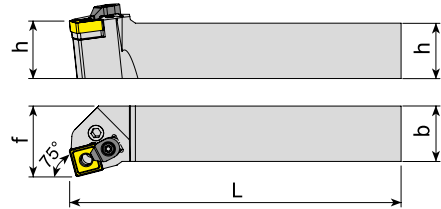

Takım Kodu Ordering Code Код для заказа	Stok Stock Наличие		Takım Ölçüleri (mm) Dimension (mm) Размеры (мм)				Kesici Uç Insert Пластина	Yedek Parçaları / Spare Parts / Запасные части						
	R	L	h	b	L	f		Levyeye Lever Рычаг	Levyeye Vidası Lever Screw Винт рычага	Altılık Shim Опорная пластина	Altılık Yayı Shim Spring Втулка рычага	Baskı Parçası Wedge Clamp Прижим	Baskı Vidası Clamp Screw Зажимной винт	Anahtar Allen Key Ключ
PSKNR/L 2020 K09	●	○	20	20	125	25	SNM. 0903..	APL-01	ALV-02-M6x17	AASN-2-0002	AAY-01	-	-	AAL-02-2.5
2020 K12C	●		20	20	125	25								
2525 M12C	●		25	25	150	32	SNM. 1204..	APL-02	ALV-03-M8x19	AASN-3-0004	AAY-02	ACK-05	4015-M4x11	AAL-03-3
3232 P12C	●		32	32	170	40								
2525 M15C	●		25	25	150	32	SNM. 1506..	APL-04	ALV-04-M8x22	AASN-3-0023	AAY-03			
3232 P15C	●		32	32	170	40								
3232 P19C	●		32	32	170	40	SNM. 1906..	APL-05	ALV-05-M10x27	AASN-3-0005	AAY-04	ACK-09	AAV-05-M6x15	AAL-05-4
4040 S19C	●		40	40	250	50								
4040 S25C	●		40	40	250	50	SNM. 2509..	APL-06	ALV-06-M12x36	AASN-3-0020	AAY-05	ACK-04	AKV-16-M6x16	AAL-07-5
5050 S25C	●	○	50	50	250	60								

R: Sağ / Right / Правый L: Sol/Left/Левый
● Stokta / In Stock / В наличии ○ Stokta Yok / Non Stock Item / Нет в наличии

Sipariş Örneği/Ordering Example/Образец заказа
1 ad./pcs./шт PSDNN 1616 H09

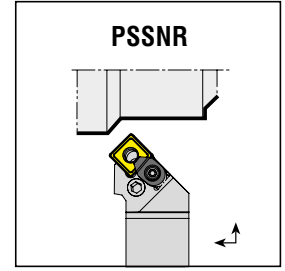
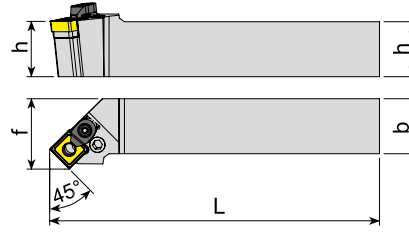

Takım Kodu Ordering Code Код для заказа	Stok Stock Наличие		Takım Ölçüleri (mm) Dimension (mm) Размеры (мм)				Kesici Uç Insert Пластина	Yedek Parçaları / Spare Parts / Запасные части						
	R	L	h	b	L	f		Levyé Lever Рычаг	Levyé Vidası Lever Screw Винт рычага	Aitlik Shim Опорная пластина	Aitlik Yay Shim Spring Втулка рычага	Baskı Parçası Wedge Clamp Прижим	Baskı Vidası Clamp Screw Зажимной винт	Anahtar Allen Key Ключ
PSSNR/L 1616 H09	●	●	16	16	100	20	SNM. 0903..	APL-01	ALV-02-M6x17	AASN-2-0002	AAV-01	-	-	AAL-02-2.5
2020 K09	●	○	20	20	125	25								
2020 K12C	●	●	20	20	125	25	SNM. 1204..	APL-02	ALV-03-M8x19	AASN-3-0004	AAV-02	ACK-05	4015-M4x11	AAL-03-3
2525 M12C	●	●	25	25	150	32								
3232 P12C	●	●	32	32	170	40	SNM. 1506..	APL-04	ALV-04-M8x22	AASN-3-0023	AAV-03			
3232 P15C	●	○	32	32	170	40								
3232 P19C	●	●	32	32	170	40	SNM. 1906..	APL-05	ALV-05-M10x27	AASN-3-0005	AAV-04	ACK-09	AAV-05-M6x15	AAL-05-4
4040 S19C	●	●	40	40	250	50								
4040 S25C	●	●	40	40	250	50	SNM. 2509..	APL-06	ALV-06-M12x36	AASN-3-0020	AAV-05	ACK-04	AKV-16-M6x16	AAL-07-5

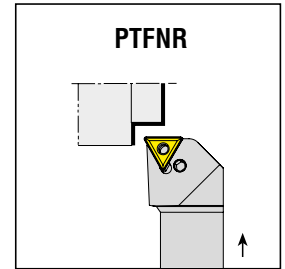
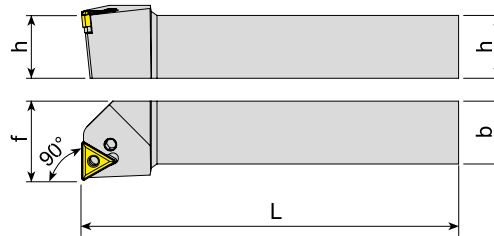

Takım Kodu Ordering Code Код для заказа	Stok Stock Наличие		Takım Ölçüleri (mm) Dimension (mm) Размеры (мм)				Kesici Uç Insert Пластина	Yedek Parçaları / Spare Parts / Запасные части						
	R	L	h	b	L	f		Levyé Lever Рычаг	Levyé Vidası Lever Screw Винт рычага	Aitlik Shim Опорная пластина	Aitlik Yay Shim Spring Втулка рычага	Baskı Parçası Wedge Clamp Прижим	Baskı Vidası Clamp Screw Зажимной винт	Anahtar Allen Key Ключ
PTFNR/L 1616 H16	●	●	16	16	100	20	TNM. 1604..	APL-01	ALV-02-M6x17	AATN-3-0025	AAV-01	-	-	AAL-02-2.5
2020 K16	●	●	20	20	125	25								
2525 M16	●	●	25	25	150	32								
3232 P16	●	●	32	32	170	40	TNM. 2204..	APL-02	ALV-03-M8x19	AATN-3-0015	AAV-02	ACK-05	4015-M4x11	AAL-03-3
2525 M22C	●	●	25	25	150	32								
3232 P22C	●	●	32	32	170	40	TNM. 2706.	07042709	07042710	07042701	07042711	-	-	AAL-05-4
4040 S27	○	○	40	40	250	50								

R: Sağ / Right / Правый L: Sol/Left/Левый

● Stokta / In Stock / В наличии ○ Stokta Yok / Non Stock Item / Нет в наличии

Sipariş Örneği/Ordering Example/Образец заказа

1 ad./pcs./шт PSSNR 1616 H09

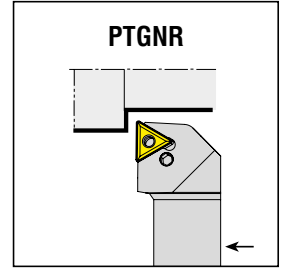
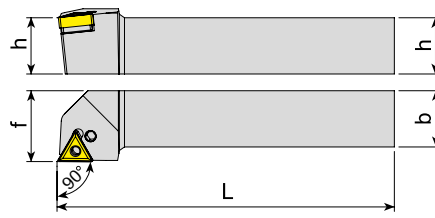

Takım Kodu Ordering Code Код для заказа	Stok Stock Наличие		Takım Ölçüleri (mm) Dimension (mm) Размеры (мм)				Kesici Uç Insert Пластина	Yedek Parçaları / Spare Parts / Запасные части													
	R	L	h	b	L	f		Levyé Lever Рычаг	Levyé Vidası Lever Screw Винт рычага	Altık Shim Опорная пластина	Altık Yayı Shim Spring Втулка рычага	Baskı Parçası Wedge Clamp Прийжим	Baskı Vidası Clamp Screw Зажимной винт	Anahtar Allen Key Ключ							
PTGNR/L 1010 E11	○	○	10	10	70	12															
1212 F11	○	○	12	12	80	16									TNM. 1103..	07041109	07041110	-	-	-	-
1616 H11	○	○	16	16	100	20															
1616 H16	●	●	16	16	100	20								AAL-02-2.5							
2020 K16	●	●	20	20	125	25	TNM. 1604..	APL-01	ALV-02-M6x17	AATN-3-0025	AAV-01	-	-								
2525 M16	●	●	25	25	150	32															
3232 P16	○	○	32	32	170	40															
2525 M22C	●	●	25	25	150	32	TNM. 2204..	APL-02	ALV-03-M8x19	AATN-3-0015	AAV-02	ACK-05	4015-M4x11	AAL-03-3							
3232 P22C	●	●	32	32	170	40															
4040 S27	○	○	40	40	250	50	TNM. 2706..	07042709	07042710	07042701	07042711	-	-	AAL-05-4							

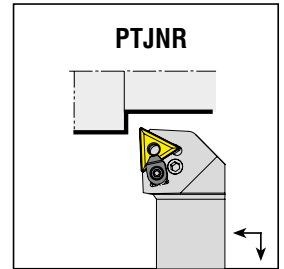
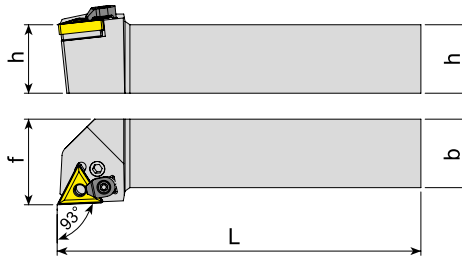

Takım Kodu Ordering Code Код для заказа	Stok Stock Наличие		Takım Ölçüleri (mm) Dimension (mm) Размеры (мм)				Kesici Uç Insert Пластина	Yedek Parçaları / Spare Parts / Запасные части													
	R	L	h	b	L	f		Levyé Lever Рычаг	Levyé Vidası Lever Screw Винт рычага	Altık Shim Опорная пластина	Altık Yayı Shim Spring Втулка рычага	Baskı Parçası Wedge Clamp Прийжим	Baskı Vidası Clamp Screw Зажимной винт	Anahtar Allen Key Ключ							
PTJNR/L 1010 E11	○	○	10	10	70	12															
1212 F11	○	○	12	12	80	16									TNM. 1103..	07041109	07041110	-	-	-	-
1616 H11	○	○	16	16	100	20															
1616 H16	●	●	16	16	100	20								AAL-02-2.5							
2020 K16	●	●	20	20	125	25	TNM. 1604..	APL-01	ALV-02-M6x17	AATN-3-0025	AAV-01	-	-								
2525 M16	●	●	25	25	150	32															
3232 P16	●	●	32	32	170	40															
2525 M22C	●	●	25	25	150	32	TNM. 2204..	APL-02	ALV-03-M8x19	AATN-3-0015	AAV-02	ACK-05	4015-M4x11	AAL-03-3							
3232 P22C	●	●	32	32	170	40															
4040 S27	●	○	40	40	250	50	TNM. 2706..	APL-05	ALV-05-M10x27	07042701	AAV-04	ACK-09	AAV-05-M6x15	AAL-05-4							

R: Sağ / Right / Правый L: Sol/Left/Левый

● Stokta / In Stock / В наличии ○ Stokta Yok / Non Stock Item / Нет в наличии

Sipariş Örneği/Ordering Example/Образец заказа

1 ad./pcs./шт PTGNR 1010 E11

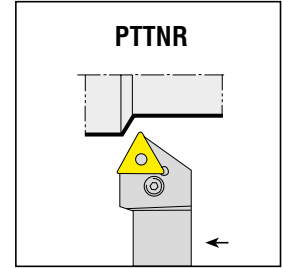
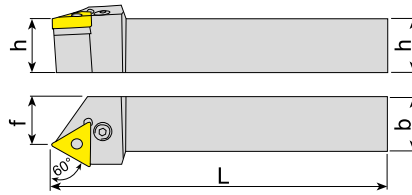

Takım Kodu
Ordering Code
Код для заказа

Stok Stock Наличие	Takım Ölçüleri (mm) Dimension (mm) Размеры (мм)					Kesici Uç Insert Пластина	Yedek Parçaları / Spare Parts / Запасные части							
	R	L	h	b	L		f	Levye Lever Рычаг	Levye Vidası Lever Screw Винт рычага	Altık Shim Опорная пластина	Altık Yay Shim Spring Втулка рычага	Baskı Parçası Wedge Clamp Прижим	Baskı Vidası Clamp Screw Зажимной винт	Anahtar Allen Key Ключ
PTTNR/L 1616 H16	●	●	16	16	100	13	TNM. 1604..	APL-01	ALV-02-M6x17	AATN-3-0025	AAV-01	-	-	AAL-02-2.5
2020 K16	●	●	20	20	125	17								
2525 M16	●	●	25	25	150	21.5								
3232 P16	●	●	32	32	170	31								
2525 M22C	●	●	25	25	150	20.5	TNM. 2204..	APL-02	ALV-03-M8x19	AATN-3-0015	AAV-02	ACK-05	4015-M4x11	AAL-03-3
3232 P22C	●	●	32	32	170	29								

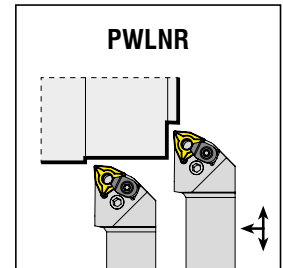
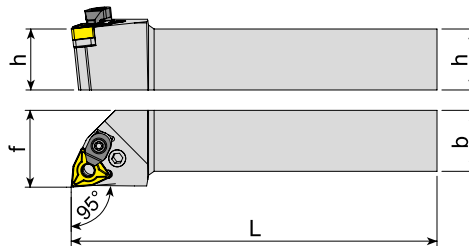

Takım Kodu
Ordering Code
Код для заказа

Stok Stock Наличие	Takım Ölçüleri (mm) Dimension (mm) Размеры (мм)					Kesici Uç Insert Пластина	Yedek Parçaları / Spare Parts / Запасные части							
	R	L	h	b	L		f	Levye Lever Рычаг	Levye Vidası Lever Screw Винт рычага	Altık Shim Опорная пластина	Altık Yay Shim Spring Втулка рычага	Baskı Parçası Wedge Clamp Прижим	Baskı Vidası Clamp Screw Зажимной винт	Anahtar Allen Key Ключ
PWLNR/L 1616 H06	●	●	16	16	100	20	WNM. 0604..	APL-01	ALV-02-M6x17	AAWN-SW317	AAV-01	-	-	AAL-02-2.5
2020 K06	●	●	20	20	125	25								
2525 M06	●	●	25	25	150	32								
3232 P06	○	○	32	32	170	40								
1616 H08	●	●	16	16	100	20	WNM. 0804..	APL-02	ALV-03-M8x19	AAWN-3-0001	AAV-02	ACK-05	4015-M4x11	AAL-03-3
2020 K08C	●	●	20	20	125	25								
2525 M08C	●	●	25	25	150	32								
3232 P08C	●	●	32	32	170	40								

R: Sağ / Right / Правый L: Sol/Left/Левый

● Stokta / In Stock / В наличии ○ Stokta Yok / Non Stock Item / Нет в наличии

Sipariş Örneği/Ordering Example/Образец заказа

1 ad./pcs./шт PTTNR 1616 H16

C-SİSTEM

C-SİSTEM DIŞ TORNA KATERLERİ

C-SYSTEM EXTERNAL TURNING TOOLHOLDERS

С-ТИП ДЕРЖАВКИ ДЛЯ НАРУЖНОГО ТОЧЕНИЯ

*konusulan
the spoken kalite...
quality...*



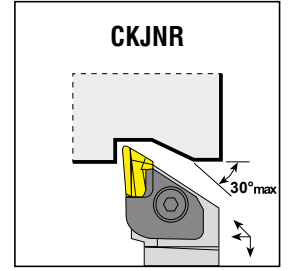
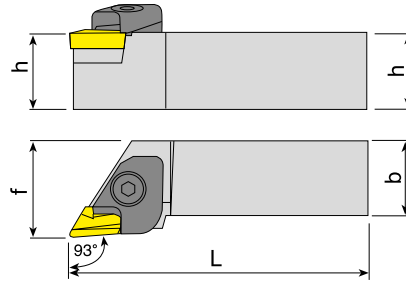

Takım Kodu
Ordering Code
Код для заказа

Stok
Stock
Наличие

Takım Ölçüleri (mm)
Dimension (mm)
Размеры (мм)

Kesici Uç
Insert
Пластина

Baskı Pabucu
Wedge Clamp
Прижим

Pabuç Vidası
Clamp Screw
Винт прижима

Altık Shim
Опорная пластина

Altık Vidası
Shim Screw
Винт опорной пластины

Yay
Spring
Пружина

Pul Stamp
Шайба

Anahtar
Allen Key
Ключ

Yedek Parçaları / Spare Parts / Запасные части

Takım Kodu Ordering Code Код для заказа	Stok Stock Наличие		Takım Ölçüleri (mm) Dimension (mm) Размеры (мм)				Kesici Uç Insert Пластина	Baskı Pabucu Wedge Clamp Прижим	Pabuç Vidası Clamp Screw Винт прижима	Altık Shim Опорная пластина	Altık Vidası Shim Screw Винт опорной пластины	Yay Spring Пружина	Pul Stamp Шайба	Anahtar Allen Key Ключ
	R	L	h	b	L	f								
CKJNR/L 2020 K16	●	●	20	20	125	27.5	KNUX 1604..							
2525 M16	●	●	25	25	150	31.5								
3232 P16	●	●	32	32	170	40								
4040 S16	●	●	40	40	250	50								

R: Sağ / Right / Правый L: Sol/Left/Левый

● Stokta / In Stock / В наличии ○ Stokta Yok / Non Stock Item / Нет в наличии

Sipariş Örneği/Ordering Example/Образец заказа

1 ad./pcs./шт CKJNR 2020 K16



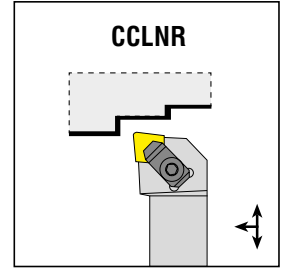
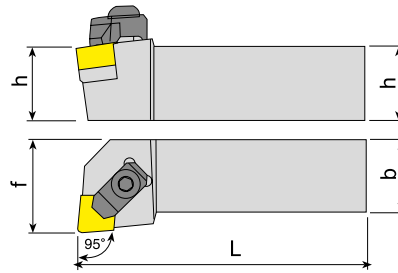
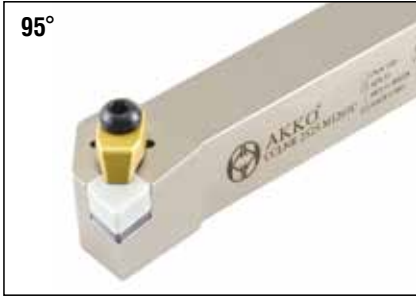

Takım Kodu Ordering Code Код для заказа	Stok Stock Наличие		Takım Ölçüleri (mm) Dimension (mm) Размеры (мм)				Kesici Uç Insert Пластина	Yedek Parçaları / Spare Parts / Запасные части					
	R	L	h	b	L	f		Baskı Pabucu Wedge Clamp Прижим	Pabuç Vidası Clamp Screw Винт прижима	Altlık Shim Опорная пластина	Altlık Vidası Shim Screw Винт опорной пластины	Sekman Ring Кольцо	Anahtar Allen Key Ключ
CCLNR/L 2525 M1207C	●	●	25	25	150	32	CN.N 1207..						
3232 P1207C	●	●	32	32	170	40							
2525 M1607C	●	●	25	25	150	32							

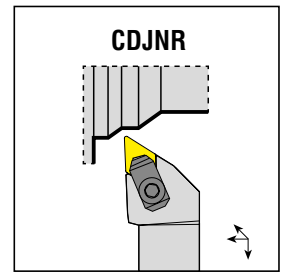
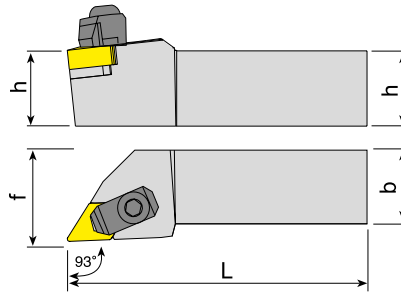

Takım Kodu Ordering Code Код для заказа	Stok Stock Наличие		Takım Ölçüleri (mm) Dimension (mm) Размеры (мм)				Kesici Uç Insert Пластина	Yedek Parçaları / Spare Parts / Запасные части					
	R	L	h	b	L	f		Baskı Pabucu Wedge Clamp Прижим	Pabuç Vidası Clamp Screw Винт прижима	Altlık Shim Опорная пластина	Altlık Vidası Shim Screw Винт опорной пластины	Sekman Ring Кольцо	Anahtar Allen Key Ключ
CDJNR/L 2525 M1107C	●	●	25	25	150	32	DN.N 1107..						
2525 M1507C	●	●	25	25	150	32							
3232 P1507C	●	●	32	32	170	40							

R: Sağ / Right / Правый L: Sol/Left/Левый
 ● Stokta / In Stock / В наличии ○ Stokta Yok / Non Stock Item / Нет в наличии

Sipariş Örneği/Ordering Example/Образец заказа
 1 ad./pcs./шт CCLNR 2525 M1207C

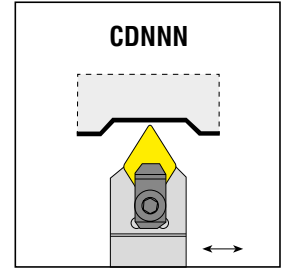
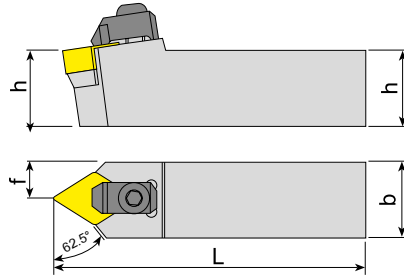

Takım Kodu Ordering Code Код для заказа	Stok Stock Наличие	Takım Ölçüleri (mm) Dimension (mm) Размеры (мм)				Kesici Uç Insert Пластина	Yedek Parçaları / Spare Parts / Запасные части					
		h	b	L	f		Baskı Pabucu Wedge Clamp Прижим	Pabuç Vidası Clamp Screw Винт прижима	Altlık Shim Опорная пластина	Altlık Vidası Shim Screw Винт опорной пластины	Sekman Ring Кольцо	Anahtar Allen Key Ключ
CDNNN 2525 M1107C	●	25	25	150	12.5	DN.N 1107..	ACK-22	AKV-11-M8x29	AADN-2-0001	AAV-04-M5x12	ACS-01	AAL-05-4

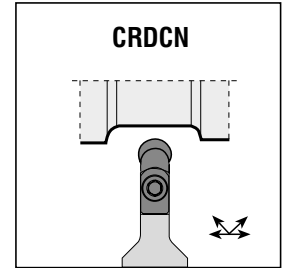
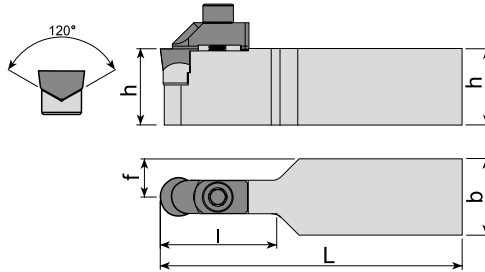

Takım Kodu Ordering Code Код для заказа	Stok Stock Наличие	Takım Ölçüleri (mm) Dimension (mm) Размеры (мм)					Kesici Uç Insert Пластина	Yedek Parçaları / Spare Parts / Запасные части				
		h	b	L	l	f		Baskı Pabucu Wedge Clamp Прижим	Pabuç Vidası Clamp Screw Винт прижима	Altlık Shim Опорная пластина	Altlık Vidası Shim Screw Винт опорной пластины	Anahtar Allen Key Ключ
CRDCN 2525 M06CV	●	25	25	150	19	12.5	RCGX 060600	ACK-27	2525-M3X14	AARC-3-0001	3007-M2.2X5	AAL-02-2.5
3225 P06CV	●	32	25	170	19	12.5						
4040 S06CV	●	40	40	250	19	20						
2525 M09CV	●	25	25	150	29	12.5	RCGX 090700	ACK-28	2504-M5X16	AARC-3-0002	3008-M2.5x6	AAL-05-4
3225 P09CV	●	32	25	170	29	12.5						
4040 S09CV	●	40	40	250	29	20						
2525 M12CV	●	25	25	150	38	12.5	RCGX 120700	ACK-29	2505-M6X20	AARC-3-0003	3008-M2.5x6	AAL-07-5
3225 P12CV	●	32	25	170	38	12.5						
4040 S12CV	●	40	40	250	38	20						

R: Sağ / Right / Правый L: Sol/Left/Левый

● Stokta / In Stock / В наличии ○ Stokta Yok / Non Stock Item / Нет в наличии

Sipariş Örneği/Ordering Example/Образец заказа

1 ad./pcs./шт CDNNN 2525 M1107C

new

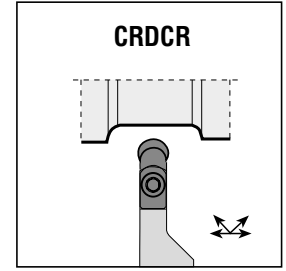
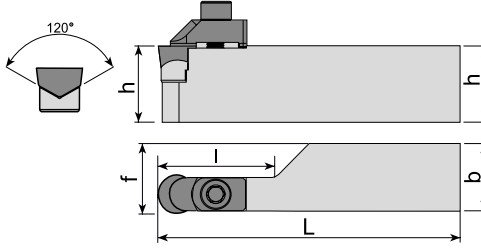

Takım Kodu Ordering Code Код для заказа	Stok Stock Наличие		Takım Ölçüleri (mm) Dimension (mm) Размеры (мм)				Kesici Uç Insert Пластина	Yedek Parçaları / Spare Parts / Запасные части					
	R	L	h	b	L	l		f	Baskı Pabuçu Wedge Clamp Прижим	Pabuç Vidası Clamp Screw Винт прижима	Altlık Shim Опорная пластина	Altlık Vidası Shim Screw Винт опорной пластины	Anahtar Allen Key Ключ
CRDCR/L 3225 P06CV	●	●	32	25	170	19.4	25.6	RCGX 060600	ACK-27	2525-M3X14	AARC-3-0001	3007-M2.2X5	AAL-02-2.5
3225 P09CV	●	●	32	25	170	29	25.8	RCGX 090700	ACK-28	2504-M5X16	AARC-3-0002	3008-M2.5x6	AAL-05-4
3225 P12CV	●	●	32	25	170	38.5	25.9	RCGX 120700	ACK-29	2505-M6X20	AARC-3-0003	3008-M2.5x6	AAL-07-5

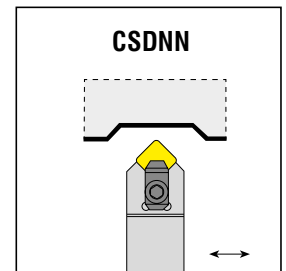
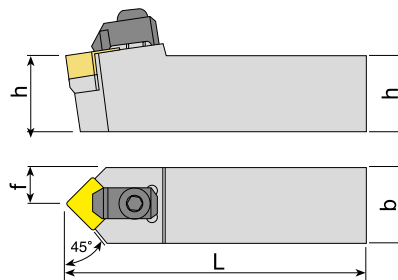

Takım Kodu Ordering Code Код для заказа	Stok Stock Наличие		Takım Ölçüleri (mm) Dimension (mm) Размеры (мм)				Kesici Uç Insert Пластина	Yedek Parçaları / Spare Parts / Запасные части					
	R	L	h	b	L	f		Baskı Pabuçu Wedge Clamp Прижим	Pabuç Vidası Clamp Screw Винт прижима	Altlık Shim Опорная пластина	Altlık Vidası Shim Screw Винт опорной пластины	Sekman Ring Кольцо	Anahtar Allen Key Ключ
CSDNN 2525 M1207C	●	●	25	25	150	12.5	SN.N 1207..	ACK-13	AKV-11-M8x29	AASN-3-0004	AAV-02-M5x12	ACS-01	AAL-05-4
3232 P1207C	●	●	32	32	170	16							

R: Sağ / Right / Правый L: Sol/Left/Левый
● Stokta / In Stock / В наличии ○ Stokta Yok / Non Stock Item / Нет в наличии

Sipariş Örneği/Ordering Example/Образец заказа
1 ad./pcs./шт CRDCR 3225 P06CV

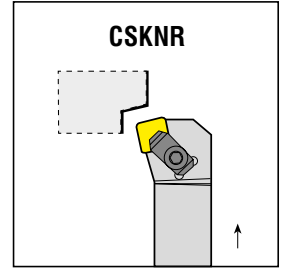
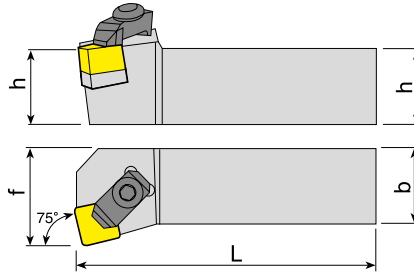
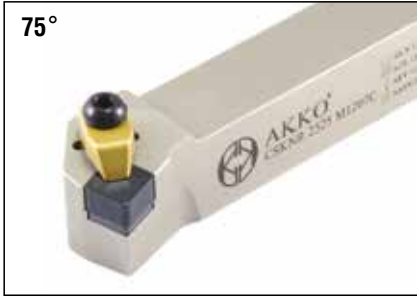

Takım Kodu Ordering Code Код для заказа	Stok Stock Наличие		Takım Ölçüleri (mm) Dimension (mm) Размеры (мм)				Kesici Uç Insert Пластина	Yedek Parçaları / Spare Parts / Запасные части					
	R	L	h	b	L	f		Baskı Pabucu Wedge Clamp Прижим	Pabuç Vidası Clamp Screw Винт прижима	Aitlik Shim Опорная пластина	Aitlik Vidası Shim Screw Винт опорной пластины	Sekman Ring Кольцо	Anahtar Allen Key Ключ
CSKNR/L 2525 M1207C	●	●	25	25	150	32	SN.N 1207..	ACK-13	AKV-11-M8x29	AASN-3-0004	AAV-02-M5x12	ACS-01	AAL-05-4
3232 P1207C	●	●	32	32	170	40							

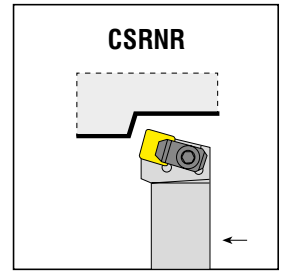
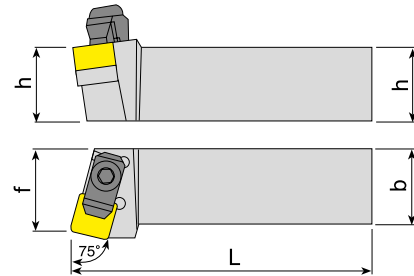

Takım Kodu Ordering Code Код для заказа	Stok Stock Наличие		Takım Ölçüleri (mm) Dimension (mm) Размеры (мм)				Kesici Uç Insert Пластина	Yedek Parçaları / Spare Parts / Запасные части					
	R	L	h	b	L	f		Baskı Pabucu Wedge Clamp Прижим	Pabuç Vidası Clamp Screw Винт прижима	Aitlik Shim Опорная пластина	Aitlik Vidası Shim Screw Винт опорной пластины	Sekman Ring Кольцо	Anahtar Allen Key Ключ
CSRNR/L 2525 M1207C	●	●	25	25	150	32	SN.N 1207..	ACK-13	AKV-11-M8x29	AASN-3-0004	AAV-02-M5x12	ACS-01	AAL-05-4
3232 P1207C	●	●	32	32	170	40							

R: Sağ / Right / Правый L: Sol/Left/Левый
● Stokta / In Stock / В наличии ○ Stokta Yok / Non Stock Item / Нет в наличии

Sipariş Örneği/Ordering Example/Образец заказа
1 ad./pcs./шт CSKNR 2525 M1207C

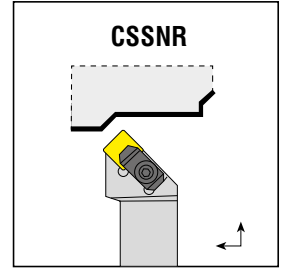
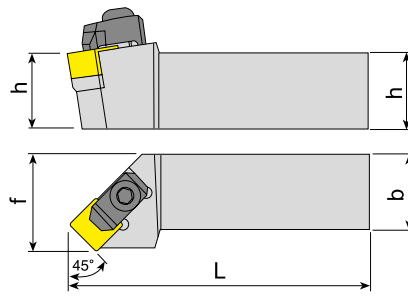

Takım Kodu Ordering Code Код для заказа	Stok Stock Наличие		Takım Ölçüleri (mm) Dimension (mm) Размеры (мм)				Kesici Uç Insert Пластина	Yedek Parçaları / Spare Parts / Запасные части					
	R	L	h	b	L	f		Baskı Pabucu Wedge Clamp Прижим	Pabuç Vidası Clamp Screw Винт прижима	Altlık Shim Опорная пластина	Altlık Vidası Shim Screw Винт опорной пластины	Sekman Ring Кольцо	Anahtar Allen Key Ключ
CSSNR/L 2525 M1207C	●	●	25	25	150	32	SN.N 1207..						
3232 P1207C	●	●	32	32	170	40							

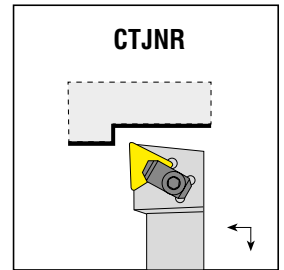
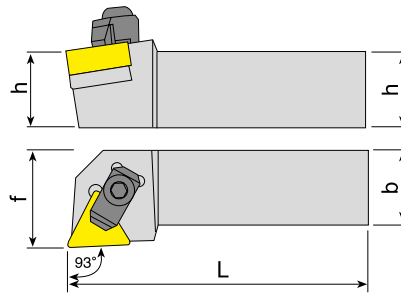

Takım Kodu Ordering Code Код для заказа	Stok Stock Наличие		Takım Ölçüleri (mm) Dimension (mm) Размеры (мм)				Kesici Uç Insert Пластина	Yedek Parçaları / Spare Parts / Запасные части					
	R	L	h	b	L	f		Baskı Pabucu Wedge Clamp Прижим	Pabuç Vidası Clamp Screw Винт прижима	Altlık Shim Опорная пластина	Altlık Vidası Shim Screw Винт опорной пластины	Sekman Ring Кольцо	Anahtar Allen Key Ключ
CTJNR/L 2525 M1607C	●	●	25	25	150	32	TN.N 1607..						
3232 P1607C	○	○	32	32	170	40							

R: Sağ / Right / Правый L: Sol/Left/Левый
● Stokta / In Stock / В наличии ○ Stokta Yok / Non Stock Item / Нет в наличии

Sipariş Örneği/Ordering Example/Образец заказа
1 ad./pcs./шт CSSNR 2525 M1207C



*konusulan
the spoken kalite...
quality...*

S-SİSTEM

S-SİSTEM DIŞ TORNA KATERLERİ
S-SYSTEM EXTERNAL TURNING TOOLHOLDERS
S-ТИП ДЕРЖАВКИ ДЛЯ НАРУЖНОГО ТОЧЕНИЯ



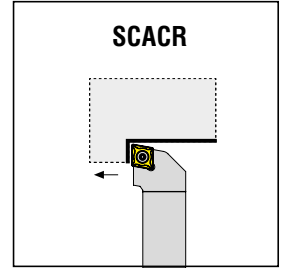
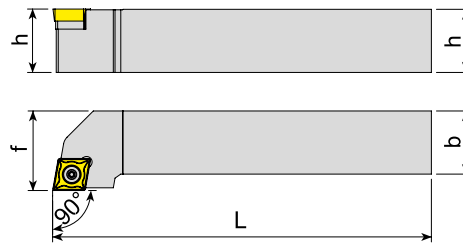

Takım Kodu
Ordering Code
Код для заказа

Stok
Stock
Наличие

Takım Ölçüleri (mm)
Dimension (mm)
Размеры (мм)

Kesici Uç
Insert
Пластина

Yedek Parçaları / Spare Parts / Залпасные части

Sıkma Vidası
Screw
Зажимной винт

Altlık
Shim
Опорная пластина

Altlık Vidası
Shim Screw
Винт опорной пластины

Tork Anahtar
Torx Key
Torx Ключ

R L

h

b

L

f



SCACR/L 0808 E06

● ●

08

08

70

10

CCM. 0602..

4008-M2.5x6

-

-

80-T08

1010 E06

● ●

10

10

70

12

CCM. 09T3..

4015-M3.5x11

-

-

80-T15

1212 F09

● ●

12

12

80

16

1616 H09

● ●

16

16

100

20

2020 K09

● ●

20

20

125

25

2020 K12

● ●

20

20

125

25

2525 M12

● ●

25

25

150

32

CCM. 1204..

1020-M4.5x16

AACN-2-0003

AAV-07-M4.5x13

80-T20

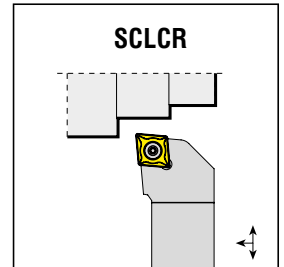
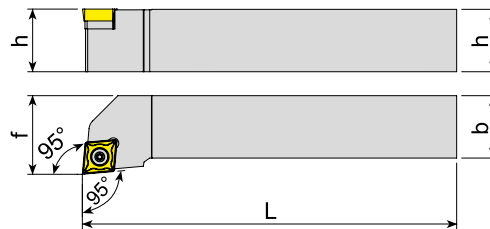

Takım Kodu
Ordering Code
Код для заказа

Stok
Stock
Наличие

Takım Ölçüleri (mm)
Dimension (mm)
Размеры (мм)

Kesici Uç
Insert
Пластина

Yedek Parçaları / Spare Parts / Залпасные части

Sıkma Vidası
Screw
Зажимной винт

Altlık
Shim
Опорная пластина

Altlık Vidası
Shim Screw
Винт опорной пластины

Tork Anahtar
Torx Key
Torx Ключ

R L

h

b

L

f



SCLCR/L 0808 E06

● ●

08

08

70

10

CCM. 0602..

4008-M2.5x6

-

-

80-T08

1010 E06

● ○

10

10

70

12

CCM. 09T3..

4015-M3x9

-

-

80-T15

1010 E09

● ●

10

10

70

12

1212 F09

● ●

12

12

80

16

1616 H09

● ●

16

16

100

20

2020 K09

● ●

20

20

125

25

2525 M09

● ●

25

25

150

32

1616 H12

● ○

16

16

100

20

2020 K12

● ●

20

20

125

25

2525 M12

● ●

25

25

150

32

CCM. 1204..

1020-M5x11

-

-

80-T20

1020-M4.5x16

AACN-2-0003

AAV-07-M4.5x13

R: Sağ / Right / Правый L: Sol/Left/Левый

● Stokta / In Stock / В наличии ○ Stokta Yok / Non Stock Item / Нет в наличии

Sipariş Örneği/Ordering Example/Образец заказа

1 ad./pcs./шт SCACR 0808 E06

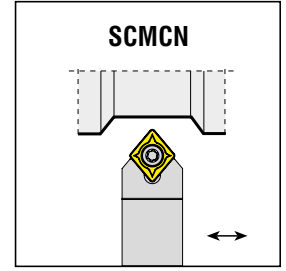
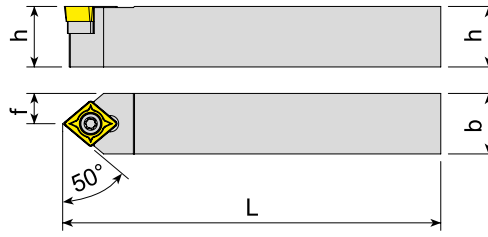

Takım Kodu Ordering Code Код для заказа	Stok Stock Наличие		Takım Ölçüleri (mm) Dimension (mm) Размеры (мм)				Kesici Uç Insert Пластина	Yedek Parçaları / Spare Parts / Запасные части			
	R	L	h	b	L	f		Sıkma Vidası Screw Зажимной винт	Altlık Shim Опорная пластина	Altlık Vidası Shim Screw Винт опорной пластины	Tork Anahtar Torx Key Торх Ключ
SCMCN 0808 E06	●		08	08	70	04					
1010 E06	●		10	10	70	05					
1212 F06	●		12	12	80	06					
1212 F09	●		12	12	80	06	CCM. 09T3..	4015-M3.5x11	-	-	80-T15
1616 H09	●		16	16	100	08		4015-M3.5x14	AACN-2-0001	AAV-06-M3.5x11	
2020 K12	●		20	20	125	10	CCM. 1204..	1020-M4.5x16	AACN-2-0003	AAV-07-M4.5x13	80-T20
2525 M12	●		25	25	150	12.5					

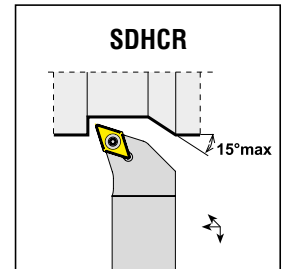
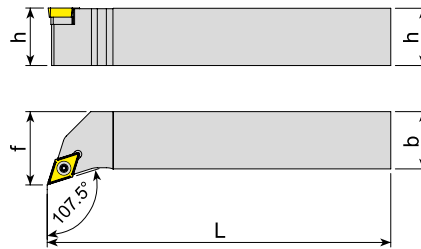

Takım Kodu Ordering Code Код для заказа	Stok Stock Наличие		Takım Ölçüleri (mm) Dimension (mm) Размеры (мм)				Kesici Uç Insert Пластина	Yedek Parçaları / Spare Parts / Запасные части			
	R	L	h	b	L	f		Sıkma Vidası Screw Зажимной винт	Altlık Shim Опорная пластина	Altlık Vidası Shim Screw Винт опорной пластины	Tork Anahtar Torx Key Торх Ключ
SDHCR/L 0808 E07	●	●	08	08	70	11					
1010 E07	●	●	10	10	70	12					
1212 F07	●	●	12	12	80	16					
1616 H07	●	●	16	16	100	20	DCM. 11T3..	4015-M3.5x14	AADN-2-0001	AAV-06-M3.5x11	80-T15
1616 H11	●	●	16	16	100	20					
2020 K11	●	●	20	20	125	25					
2525 M11	●	●	25	25	150	32					
3232 P11	●	●	32	32	170	40					

R: Sağ / Right / Правый L: Sol/Left/Левый

● Stokta / In Stock / В наличии ○ Stokta Yok / Non Stock Item / Нет в наличии

Sipariş Örneği/Ordering Example/Образец заказа

1 ad./pcs./шт SCMCN 0808 E06

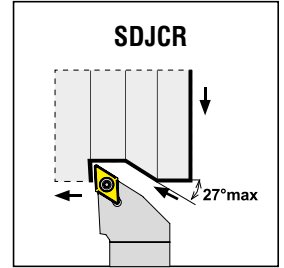
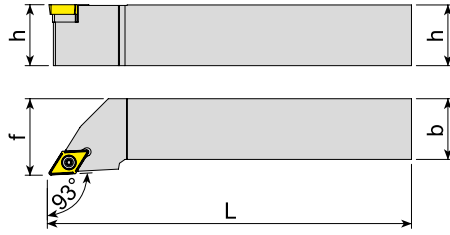
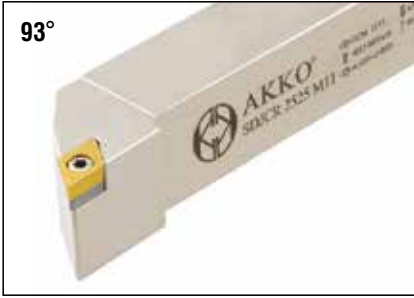

Takım Kodu Ordering Code Код для заказа	Stok Stock Наличие		Takım Ölçüleri (mm) Dimension (mm) Размеры (мм)				Kesici Uç Insert Пластина	Yedek Parçaları / Spare Parts / Залпасные части			
	R	L	h	b	L	f		Sıkma Vidası Screw Зажимной винт	Altlık Shim Опорная пластина	Altlık Vidası Shim Screw Винт опорной пластины	Tork Anahtar Torx Key Торх Ключ
SDJCR/L 0808 E07	●	●	08	08	70	10					
1010 E07	●	●	10	10	70	12					
1212 F07	●	●	12	12	80	16					
1616 H07	●	●	16	16	100	20					
1616 H11	●	●	16	16	100	20					
2020 K11	●	●	20	20	125	25					
2525 M11	●	●	25	25	150	32					
3232 P11	●	●	32	32	170	40					

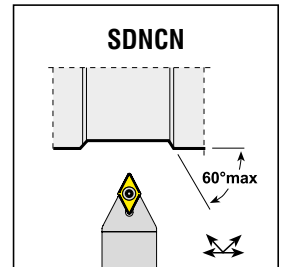
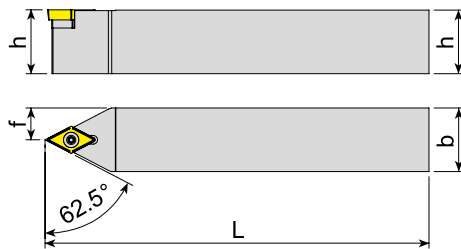

Takım Kodu Ordering Code Код для заказа	Stok Stock Наличие		Takım Ölçüleri (mm) Dimension (mm) Размеры (мм)				Kesici Uç Insert Пластина	Yedek Parçaları / Spare Parts / Залпасные части			
	R	L	h	b	L	f		Sıkma Vidası Screw Зажимной винт	Altlık Shim Опорная пластина	Altlık Vidası Shim Screw Винт опорной пластины	Tork Anahtar Torx Key Торх Ключ
SDNCN 0808 E07	●		08	08	70	4					
1010 E07	●		10	10	70	5					
1212 F07	●		12	12	80	6					
1616 H07	●		16	16	100	8					
1616 H11	●		16	16	100	8					
2020 K11	●		20	20	125	10					
2525 M11	●		25	25	150	12.5					
3232 P11	●		32	32	170	16					

R: Sağ / Right / Правый L: Sol/Left/Левый

● Stokta / In Stock / В наличии ○ Stokta Yok / Non Stock Item / Нет в наличии

Sipariş Örneği/Ordering Example/Образец заказа

1 ad./pcs./шт SDJCR 0808 E07

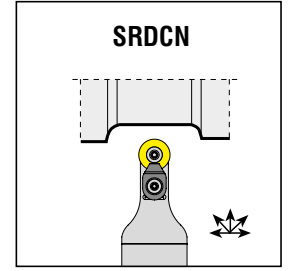
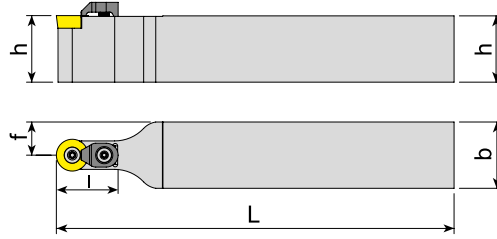

Takım Kodu Ordering Code Код для заказа	Stok Stock Наличие	Takım Ölçüleri (mm) Dimension (mm) Размеры (мм)					Kesici Uç Insert Пластина	Yedek Parçaları / Spare Parts / Залпасные части								
		h	b	L	l	f		Sıkma Vidası Screw Зажимной винт	Altık Shim Отверстие пластины	Altık Vidası Shim Screw Винт отверстия пластины	Baskı Parçası Wedge Clamp Прижим	Baskı Vidası Clamp Screw Зажимной винт	Tork Anahtar Torx Key Торх Ключ			
SRDCN 1616 H06	●	16	16	100	15	8										
2020 K06	●	20	20	125	17	10	RC.T 0602..	3008-M2.5x6	-	-	-	-	-	-	-	-
2525 M06	●	25	25	150	17	12.5										
1616 H08C	●	16	16	100	15	8										80-T08
2020 K08C	●	20	20	125	20	10	RC.T 0803..	3008-M3x8	-	-	-	-	-	-	-	-
2525 M08C	●	25	25	150	20	12.5										
1616 H10C	●	16	16	100	20	8						ACK-15	4015-M3.5x11			
2020 K10C	●	20	20	125	20	10										
2525 M10C	●	25	25	150	20	12.5	RC.T 10T3..	4015-M3.5x11	-	-	-	-	-	-	-	-
3232 P10C	●	32	32	170	20	16										80-T15
2020 K12C	●	20	20	125	22	10										
2525 M12C	●	25	25	150	22	12.5	RC.T 1204..	4015-M3.5x11	-	-	-	-	-	-	-	-
3232 P12C	●	32	32	170	22	16										
2525 M16C	●	25	25	150	32	12.5						ACK-05	4015-M4x11			
3232 P16C	●	32	32	170	35	16	RC.T 1605..	1020-M5x11	-	-	-	-	-	-	-	-
2525 M20C	●	25	25	150	32	12.5										80-T20
3232 P20C	●	32	32	170	40	16	RC.T 2006..	1420-M6x16	-	-	-	-	-	-	-	-
3232 P25C	●	32	32	170	40	16	RC.T 2507..	1520-M6x16	-	-	-	ACK-09	AAV-05-M6x15			
3232 P32C	●	32	32	170	45	16	RC.T 3209..	1904-M8x1x20	-	-	-	-	-	-	-	-

R: Sağ / Right / Правый L: Sol/Left/Левый

● Stokta / In Stock / В наличии ○ Stokta Yok / Non Stock Item / Нет в наличии

Sipariş Örneği/Ordering Example/Образец заказа

1 ad./pcs./шт SRDCN 1616 H06



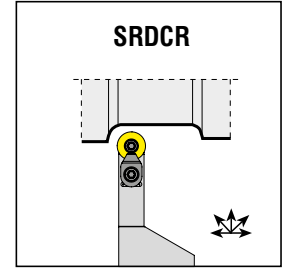
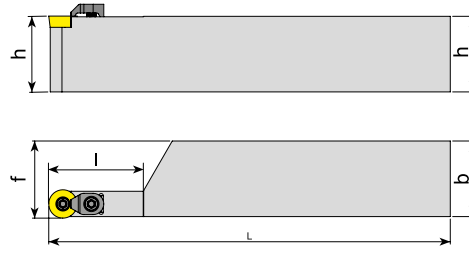

Takım Kodu Ordering Code Код для заказа	Stok Stock Наличие		Takım Ölçüleri (mm) Dimension (mm) Размеры (мм)					Kesici Uç Insert Пластина	Yedek Parçaları / Spare Parts / Залпасные части					
	R	L	h	b	L	l	f		Sıkma Vidası Screw Зажимной винт	Altık Shim Опорная пластина	Altık Vidası Shim Screw Винт опорной пластины	Baskı Parçası Wedge Clamp Прижим	Baskı Vidası Clamp Screw Зажимной винт	Tork Anahtar Torx Key Торх Ключ
	●	●												
SRDCR/L 3232 P12C	●	●	32	32	170	40	32.6	RC.T 1204..	4015-M3.5x11	-	-	ACK-05	4015-M4x11	80-T15

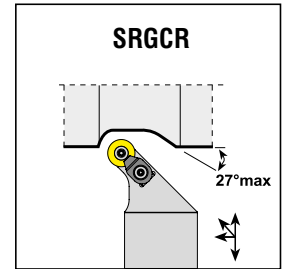
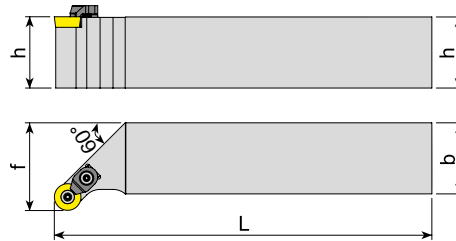

Takım Kodu Ordering Code Код для заказа	Stok Stock Наличие		Takım Ölçüleri (mm) Dimension (mm) Размеры (мм)				Kesici Uç Insert Пластина	Yedek Parçaları / Spare Parts / Залпасные части					
	R	L	h	b	L	f		Sıkma Vidası Screw Зажимной винт	Altık Shim Опорная пластина	Altık Vidası Shim Screw Винт опорной пластины	Baskı Parçası Wedge Clamp Прижим	Baskı Vidası Clamp Screw Зажимной винт	Tork Anahtar Torx Key Торх Ключ
	●	●											
SRGCR/L 1616 H06	●	●	16	16	100	20	RC.T 0602..	3008-M2.5x6	-	-	-	-	80-T08
2020 K06	●	●	20	20	125	25							
1616 H08C	●	●	16	16	100	20	RC.T 0803..	3008-M3x8	-	-	ACK-15	4015-M3.5x11	80-T15
2020 K08C	●	●	20	20	125	25							
2525 M08C	●	●	25	25	150	32	RC.T 10T3..	4015-M3.5x11	-	-	ACK-05	4015-M4x11	80-T15
1616 H10C	●	●	16	16	100	20							
2020 K10C	●	●	20	20	125	25							
2525 M10C	●	●	25	25	150	32	RC.T 1204..	4015-M3.5x11	-	-	ACK-05	4015-M4x11	80-T15
3232 P10C	●	●	32	32	170	40							
2020 K12C	●	●	20	20	125	25	RC.T 1204..	4015-M3.5x11	-	-	ACK-05	4015-M4x11	80-T15
2525 M12C	●	●	25	25	150	32							
3232 P12C	●	●	32	32	170	40							

R: Sağ / Right / Правый L: Sol/Left/Левый

● Stokta / In Stock / В наличии ○ Stokta Yok / Non Stock Item / Нет в наличии

Sipariş Örneği/Ordering Example/Образец заказа

1 ad./pcs./шт SRDCR 3232 P12C

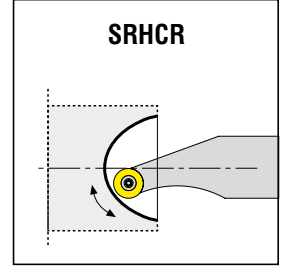
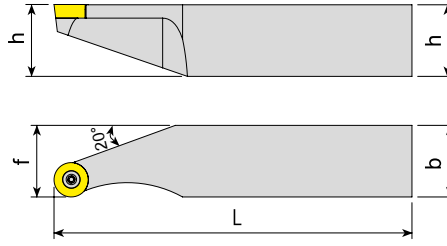

Takım Kodu Ordering Code Код для заказа	Stok Stock Наличие		Takım Ölçüleri (mm) Dimension (mm) Размеры (мм)				Kesici Uç Insert Пластина	Yedek Parçaları / Spare Parts / Запасные части				
	R	L	h	b	L	f		min R	Sıkma Vidası Screw Зажимной винт	Altlık Shim Опорная пластина	Altlık Vidası Shim Screw Винт опорной пластины	Tork Anahtar Torx Key Торх Ключ
SRHCR/L 2525 K06	●	○	25	25	125	25	32.5	RCM. 0602..	3008-M2.5x6	-	-	80-T08
2525 K08	●	●	25	25	125	25	32.5	RCM. 0803..	3008-M3x8	-	-	80-T08
2525 K10	●	●	25	25	125	25	36	RCM. 10T3..	4015-M3.5x11	-	-	80-T15
2525 K12	●	●	25	25	125	25	40	RCM. 1204..	4015-M3.5x11	-	-	80-T15
2525 K16	●	●	25	25	125	25	47.5	RCM. 1606..	1020-M5x11	-	-	80-T20

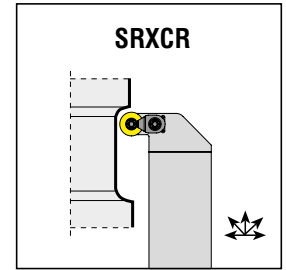
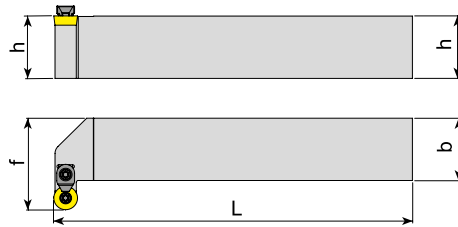

Takım Kodu Ordering Code Код для заказа	Stok Stock Наличие		Takım Ölçüleri (mm) Dimension (mm) Размеры (мм)				Kesici Uç Insert Пластина	Sıkma Vidası Screw Зажимной винт	Altlık Shim Опорная пластина	Altlık Vidası Shim Screw Винт опорной пластины	Baskı Parçası Wedge Clamp Прижим	Baskı Vidası Clamp Screw Зажимной винт	Tork Anahtar Torx Key Торх Ключ
	R	L	h	b	L	f							
SRXCR/L 3232 X08C	●	●	32	32	220	47	RC.T 0803..	3008-M3x8	-	-	ACK-15	4015-M3.5x11	80-T08
3232 X10C	●	●	32	32	220	47	RC.T 10T3..	4015-M3.5x11	-	-	ACK-05	4015-M4x11	80-T15
3232 X12C	●	●	32	32	220	47	RC.T 1204..	4015-M3.5x11	-	-	ACK-05	4015-M4x11	80-T15

R: Sağ / Right / Правый L: Sol/Left/Левый
● Stokta / In Stock / В наличии ○ Stokta Yok / Non Stock Item / Нет в наличии

Sipariş Örneği/Ordering Example/Образец заказа
1 ad./pcs./шт SRHCR 2525 K16

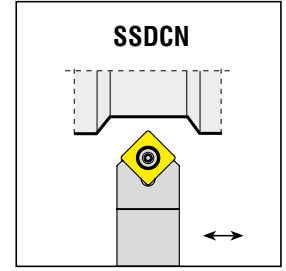
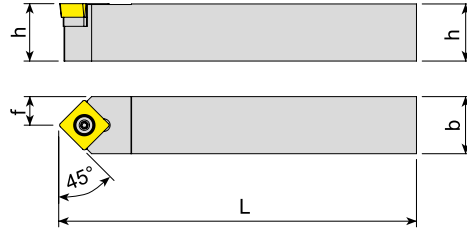

Takım Kodu Ordering Code Код для заказа	Stok Stock Наличие	Takım Ölçüleri (mm) Dimension (mm) Размеры (мм)				Kesici Uç Insert Пластина	Yedek Parçaları / Spare Parts / Запасные части			
		h	b	L	f		Sıkma Vidası Screw Зажимной винт	Altlık Shim Опорная пластина	Altlık Vidası Shim Screw Винт опорной пластины	Tork Anahtar Torx Key Торх Ключ
SSDCN 1212 F09	●	12	12	80	6	SC.T 09T3..	4015-M3.5x11	-	-	80-T15
1616 H09	●	16	16	100	8		4015-M3.5x14	AASN-2-0001	AAV-06-M3.5x11	
2020 K09	●	20	20	125	10		4020-M4.5x12	AASN-2-0004	AAV-10-M4.5x8	
1616 H12	●	16	16	100	8	SC.T 1204..	1020-M4.5x16	AASN-2-0004	AAV-07-M4.5x13	80-T20
2020 K12	●	20	20	125	10					
2525 M12	●	25	25	150	12.5					

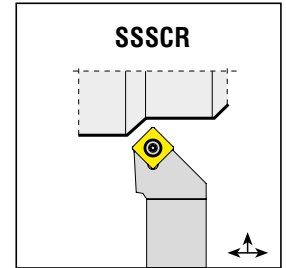
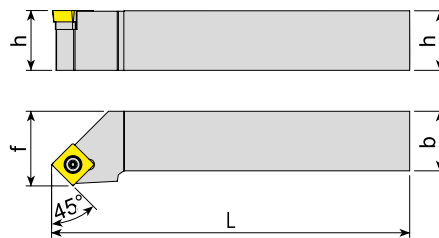

Takım Kodu Ordering Code Код для заказа	Stok Stock Наличие		Takım Ölçüleri (mm) Dimension (mm) Размеры (мм)				Kesici Uç Insert Пластина	Yedek Parçaları / Spare Parts / Запасные части			
	R	L	h	b	L	f		Sıkma Vidası Screw Зажимной винт	Altlık Shim Опорная пластина	Altlık Vidası Shim Screw Винт опорной пластины	Tork Anahtar Torx Key Торх Ключ
SSSCR/L 1212 F09	●	●	12	12	80	16	SC.T 09T3..	4015-M3.5x11	-	-	80-T15
1616 H09	●	●	16	16	100	20		4015-M3.5x14	AASN-2-0001	AAV-06-M3.5x11	
2020 K09	●	●	20	20	125	25		4020-M4.5x12	AASN-2-0004	AAV-10-M4.5x8	
1616 H12	●	●	16	16	100	20	SC.T 1204..	1020-M4.5x16	AASN-2-0004	AAV-07-M4.5x13	80-T20
2020 K12	●	●	20	20	125	25					
2525 M12	●	●	25	25	150	32					

R: Sağ / Right / Правый L: Sol/Left/ Левый

● Stokta / In Stock / В наличии ○ Stokta Yok / Non Stock Item / Нет в наличии

Sipariş Örneği/Ordering Example/Образец заказа

1 ad./pcs./шт SSDCN 1212 F09

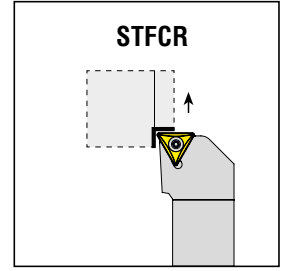
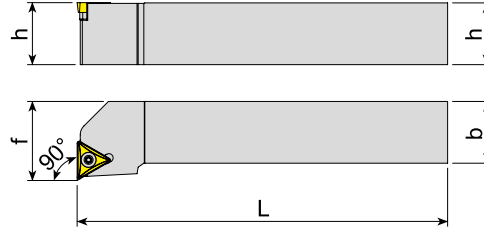

Takım Kodu Ordering Code Код для заказа	Stok Stock Наличие		Takım Ölçüleri (mm) Dimension (mm) Размеры (мм)				Kesici Uç Insert Пластина	Yedek Parçaları / Spare Parts / Запасные части								
	R	L	h	b	L	f		Sıkma Vidası Screw Зажимной винт	Altlık Shim Опорная пластина	Altlık Vidası Shim Screw Винт опорной пластины	Tork Anahtar Torx Key Торх Ключ					
	○	●														
STFCR/L 0808 E09	○	○	08	08	70	10										
1010 E09	●	●	10	10	70	12						TC.T 0902..	3007-M2.2x5	-	-	80-T07
1212 F11	●	●	12	12	80	16						TC.T 1102..	4008-M2.5x6	-	-	80-T08
1616 H11	●	●	16	16	100	20										
1616 H16	●	●	16	16	100	20						TC.T 16T3..	4015-M3.5x14	AATN-2-0001	AAV-06-M3.5x11	80-T15
2020 K16	●	●	20	20	125	25										
2525 M16	●	●	25	25	150	32										
3232 P16	●	●	32	32	170	40										

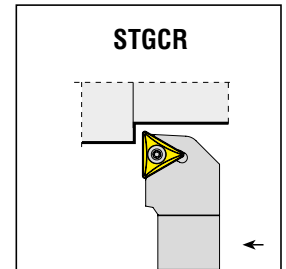
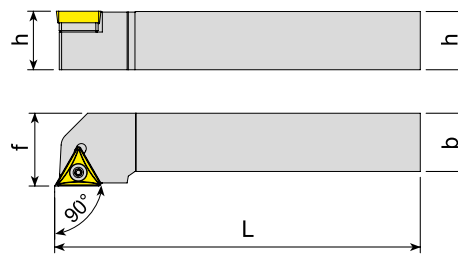

Takım Kodu Ordering Code Код для заказа	Stok Stock Наличие		Takım Ölçüleri (mm) Dimension (mm) Размеры (мм)				Kesici Uç Insert Пластина	Yedek Parçaları / Spare Parts / Запасные части								
	R	L	h	b	L	f		Sıkma Vidası Screw Зажимной винт	Altlık Shim Опорная пластина	Altlık Vidası Shim Screw Винт опорной пластины	Tork Anahtar Torx Key Торх Ключ					
	○	●														
STGCR/L 0808 E09	●	●	08	08	70	10										
1010 E09	●	●	10	10	70	12						TC.T 0902..	3007-M2.2x5	-	-	80-T07
1212 F11	●	●	12	12	80	16						TC.T 1102..	4008-M2.5x6	-	-	80-T08
1616 H11	●	●	16	16	100	20										
1616 H16	●	●	16	16	100	20						TC.T 16T3..	4015-M3.5x14	AATN-2-0001	AAV-06-M3.5x11	80-T15
2020 K16	●	●	20	20	125	25										
2525 M16	●	●	25	25	150	32										
3232 P16	●	●	32	32	170	40										

R: Sağ / Right / Правый L: Sol/Left/Левый

● Stokta / In Stock / В наличии ○ Stokta Yok / Non Stock Item / Нет в наличии

Sipariş Örneği/Ordering Example/Образец заказа

1 ad./pcs./шт STFGR 0808 E09

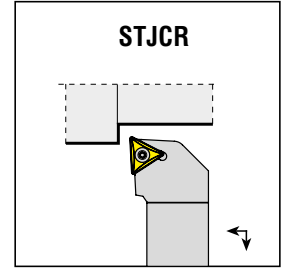
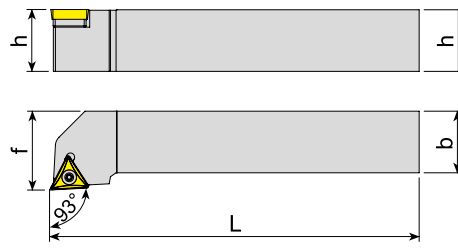

Takım Kodu
Ordering Code
Код для заказа

Stok
Stock
Наличие

Takım Ölçüleri (mm)
Dimension (mm)
Размеры (мм)

Kesici Uç
Insert
Пластина

Sıkma Vidası
Screw
Зажимной винт

Altlık
Shim
Опорная пластина

Altlık Vidası
Shim Screw
Винт опорной пластины

Tork Anahtar
Torx Key
Торх Ключ

R L

h b L f

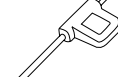

- STJCR/L 0808 E09
- 1010 E09
- 1212 F11
- 1616 H11
- 1616 H16
- 2020 K16
- 2525 M16
- 3232 P16

Stok	h	b	L	f
●	08	08	70	10
●	10	10	70	12
●	12	12	80	16
●	16	16	100	20
●	16	16	100	20
●	20	20	125	25
●	25	25	150	32
●	32	32	170	40

TC.T 0902..

3007-M2.2x5

-

-

80-T07

TC.T 1102..

4008-M2.5x6

80-T08

TC.T 16T3..

4015-M3.5x14

AATN-2-0001

AAV-06-M3.5x11

80-T15

Yedek Parçaları / Spare Parts / Запасные части

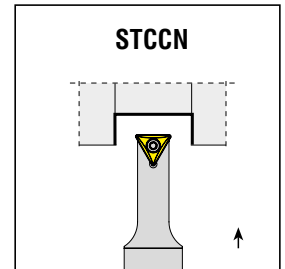
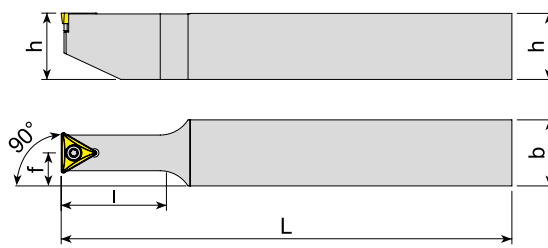

Takım Kodu
Ordering Code
Код для заказа

Stok
Stock
Наличие

Takım Ölçüleri (mm)
Dimension (mm)
Размеры (мм)

Kesici Uç
Insert
Пластина

Sıkma Vidası
Screw
Зажимной винт

Altlık
Shim
Опорная пластина

Altlık Vidası
Shim Screw
Винт опорной пластины

Tork Anahtar
Torx Key
Торх Ключ

h b L f l

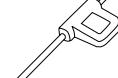

- STCCN 2020 L11
- 1616 K16
- 2020 M16
- 2525 P16
- 3232 R16
- 2525 P22

Stok	h	b	L	f	l
●	20	20	140	10	50
●	16	16	125	8	24
●	20	20	150	10	30
●	25	25	170	12.5	37.5
●	32	32	200	16	48
●	25	25	170	12.5	80

TC.T 1102..

4008-M2.5x6

-

-

80-T08

TC.T 16T3..

4015-M3.5x14

AATN-2-0001

AAV-06-M3.5x11

80-T15

TC.T 2204..

4020-M4.5x12

-

-

80-T20

Yedek Parçaları / Spare Parts / Запасные части

R: Sağ / Right / Правый L: Sol/Left/Левый
● Stokta / In Stock / В наличии ○ Stokta Yok / Non Stock Item / Нет в наличии

Sipariş Örneği/Ordering Example/Образец заказа
1 ad./pcs./шт STJCR 0808 E09

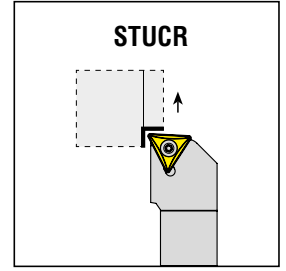
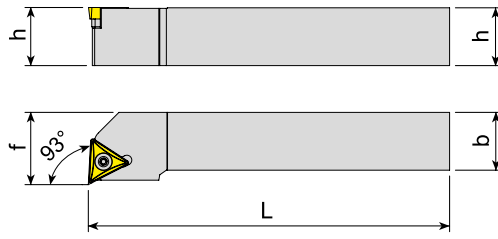

Takım Kodu
Ordering Code
Код для заказа

Stok
Stock
Наличие

Takım Ölçüleri (mm)
Dimension (mm)
Размеры (мм)

Kesici Uç
Insert
Пластина

Sıkma Vidası
Screw
Зажимной винт

Altık Shim
Опорная пластина

Altık Vidası
Shim Screw
Винт опорной пластины

Tork Anahtar
Torx Key
Торх Ключ

R	L	h	b	L	f
●	●	08	08	70	10
●	●	10	10	70	12
●	●	12	12	80	16
●	●	16	16	100	20
○	○	16	16	100	20
●	●	20	20	125	25
●	●	25	25	150	32
●	●	32	32	170	40

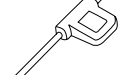

STUCR/L 0808 E09	●	●	08	08	70	10	TC.T 0902..	3007-M2.2x5	-	-	80-T07
1010 E09	●	●	10	10	70	12					
1212 F11	●	●	12	12	80	16	TC.T 1102..	4008-M2.5x6	-	-	80-T08
1616 H11	●	●	16	16	100	20					
1616 H16	○	○	16	16	100	20	TC.T 16T3..	4015-M3.5x14	AATN-2-0001	AAV-06-M3.5x11	80-T15
2020 K16	●	●	20	20	125	25					
2525 M16	●	●	25	25	150	32					
3232 P16	●	●	32	32	170	40					

Yedek Parçaları / Spare Parts / Запасные части

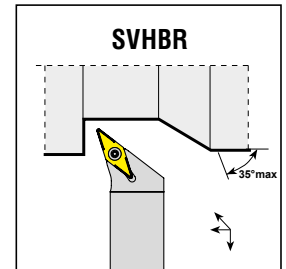
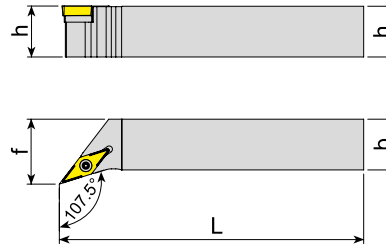

Takım Kodu
Ordering Code
Код для заказа

Stok
Stock
Наличие

Takım Ölçüleri (mm)
Dimension (mm)
Размеры (мм)

Kesici Uç
Insert
Пластина

Sıkma Vidası
Screw
Зажимной винт

Altık Shim
Опорная пластина

Altık Vidası
Shim Screw
Винт опорной пластины

Tork Anahtar
Torx Key
Торх Ключ

R	L	h	b	L	f
●	●	12	12	80	16
●	●	16	16	100	20
●	●	20	20	125	25
●	●	20	20	125	25
●	●	25	25	150	32
●	●	32	32	170	40

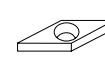

SVHBR/L 1212 F11	●	●	12	12	80	16	VBM. 1103..	4008-M2.5x6	-	-	80-T08
1616 H11	●	●	16	16	100	20					
2020 K11	●	●	20	20	125	25	VBM. 1604..	4015-M3.5x14	AAVN-2-0002	AAV-06-M3.5x11	80-T15
2020 K16	●	●	20	20	125	25					
2525 M16	●	●	25	25	150	32					
3232 P16	●	●	32	32	170	40					

Yedek Parçaları / Spare Parts / Запасные части

R: Sağ / Right / Правый L: Sol/Left/Левый
● Stokta / In Stock / В наличии ○ Stokta Yok / Non Stock Item / Нет в наличии

Sipariş Örneği/Ordering Example/Образец заказа
1 ad./pcs./шт STUCR 0808 E09

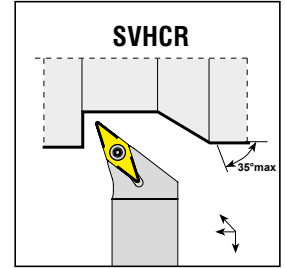
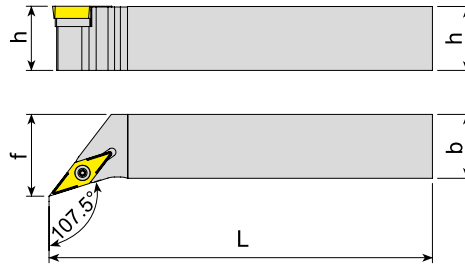

Takım Kodu Ordering Code Код для заказа	Stok Stock Наличие		Takım Ölçüleri (mm) Dimension (mm) Размеры (мм)				Kesici Uç Insert Пластина	Yedek Parçaları / Spare Parts / Запасные части			
	R	L	h	b	L	f		Sıkma Vidası Screw Зажимной винт	Altlık Shim Опорная пластина	Altlık Vidası Shim Screw Винт опорной пластины	Tork Anahtar Torx Key Торх Ключ
SVHCR/L 1212 F11	●	●	12	12	80	16					
1616 H11	●	●	16	16	100	20					
2020 K11	●	●	20	20	125	25					
2020 K16	●	●	20	20	125	25					
2525 M16	●	●	25	25	150	32					
3232 P16	●	●	32	32	170	40					

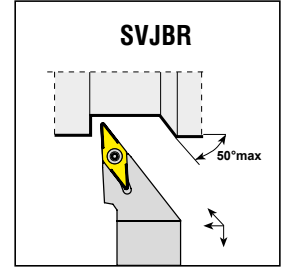
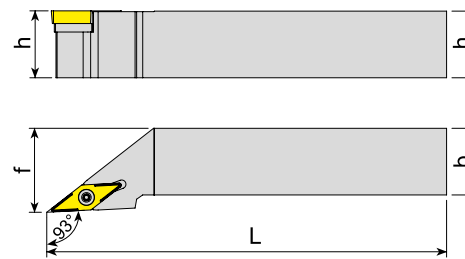

Takım Kodu Ordering Code Код для заказа	Stok Stock Наличие		Takım Ölçüleri (mm) Dimension (mm) Размеры (мм)				Kesici Uç Insert Пластина	Yedek Parçaları / Spare Parts / Запасные части			
	R	L	h	b	L	f		Sıkma Vidası Screw Зажимной винт	Altlık Shim Опорная пластина	Altlık Vidası Shim Screw Винт опорной пластины	Tork Anahtar Torx Key Торх Ключ
SVJBR/L 1212 F11	●	●	12	12	80	16					
1616 H11	●	●	16	16	100	20					
2020 K11	●	●	20	20	125	25					
1616 H16	●	●	16	16	100	20					
2020 K16	●	●	20	20	125	25					
2525 M16	●	●	25	25	150	32					
3232 P16	●	●	32	32	170	40					

R: Sağ / Right / Правый L: Sol/Left/Левый
● Stokta / In Stock / В наличии ○ Stokta Yok / Non Stock Item / Нет в наличии

Sipariş Örneği/Ordering Example/Образец заказа
1 ad./pcs./шт SVHCR 1212 F11

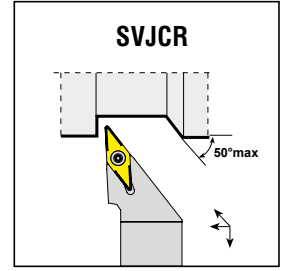
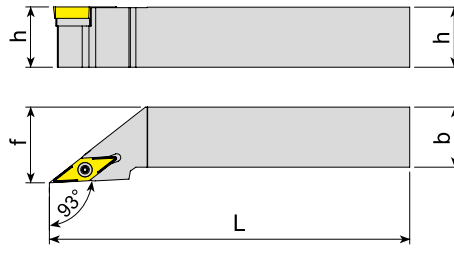

Takım Kodu Ordering Code Код для заказа	Stok Stock Наличие		Takım Ölçüleri (mm) Dimension (mm) Размеры (мм)				Kesici Uç Insert Пластина	Yedek Parçaları / Spare Parts / Запасные части			
	R	L	h	b	L	f		Sıkma Vidası Screw Зажимной винт	Altlık Shim Опорная пластина	Altlık Vidası Shim Screw Винт опорной пластины	Tork Anahtar Torx Key Торх Ключ
SVJCR/L 1212 F11	●	●	12	12	80	16	VC.T 1103..	4008-M2.5x6	-	-	80-T08
1616 H11	●	●	16	16	100	20					
2020 K11	●	●	20	20	125	25					
1212 F16	●	●	12	12	80	16	VC.T 1604..	4015-M3.5x11	AAVN-2-0002	AAV-06-M3.5x11	80-T15
2020 K16	●	●	20	20	125	25		4015-M3.5x14			
2525 M16	●	●	25	25	150	32					
3232 P16	●	●	32	32	170	40					

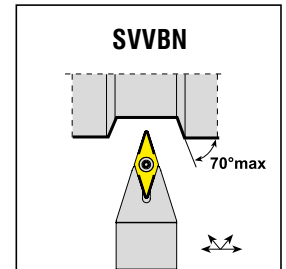
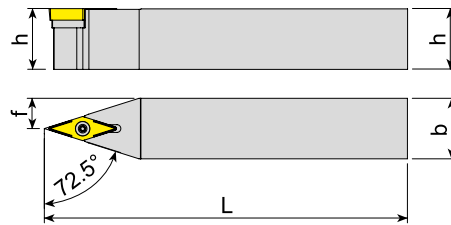

Takım Kodu Ordering Code Код для заказа	Stok Stock Наличие		Takım Ölçüleri (mm) Dimension (mm) Размеры (мм)				Kesici Uç Insert Пластина	Yedek Parçaları / Spare Parts / Запасные части			
			h	b	L	f		Sıkma Vidası Screw Зажимной винт	Altlık Shim Опорная пластина	Altlık Vidası Shim Screw Винт опорной пластины	Tork Anahtar Torx Key Торх Ключ
SVVBN 1212 F11	●		12	12	80	06	VBM. 1103..	4008-M2.5x6	-	-	80-T08
1616 H11	●		16	16	100	08					
2020 K11	●		20	20	125	10					
2020 K16	●		20	20	125	10	VBM. 1604..	4015-M3.5x14	AAVN-2-0002	AAV-06-M3.5x11	80-T15
2525 M16	●		25	25	150	12.5					
3232 P16	●		32	32	170	16					

R: Sağ / Right / Правый L: Sol/Left/Левый
● Stokta / In Stock / В наличии ○ Stokta Yok / Non Stock Item / Нет в наличии

Sipariş Örneği/Ordering Example/Образец заказа
1 ad./pcs./шт SVJCR 1212 F11

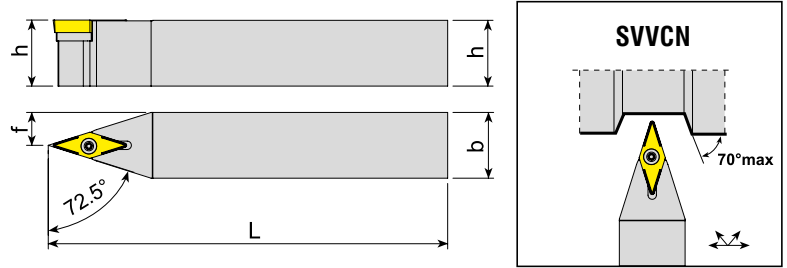

Takım Kodu Ordering Code Код для заказа	Stok Stock Наличие	Takım Ölçüleri (mm) Dimension (mm) Размеры (мм)				Kesici Uç Insert Пластина	Yedek Parçaları / Spare Parts / Запасные части			
		h	b	L	f		Sıkma Vidası Screw Зажимной винт	Altlık Shim Опорная пластина	Altlık Vidası Shim Screw Винт опорной пластины	Tork Anahtar Torx Key Торх Ключ
SVVCN 1212 F11	●	12	12	80	06	VC.T 1103..	4008-M2.5x6	-	-	80-T08
1616 H11	●	16	16	100	08					
2020 K11	●	20	20	125	10					
2020 K16	●	20	20	125	10	VC.T 1604..	4015-M3.5x14	AAVN-2-0002	AAV-06-M3.5x11	80-T15
2525 M16	●	25	25	150	12.5					
3232 P16	●	32	32	170	16					

S-SİSTEM İSVİÇRE TİPİ KAYAR OTOMAT MAKİNA TAKIMLARI
S-SYSTEM TOOLS FOR SWISS TYPE SLIDING AUTOMATIC LATHES
S-ТИП ДЕРЖАВКИ ДЛЯ ШВЕЙЦАРСКИХ СТАНКОВ АВТОМАТОВ

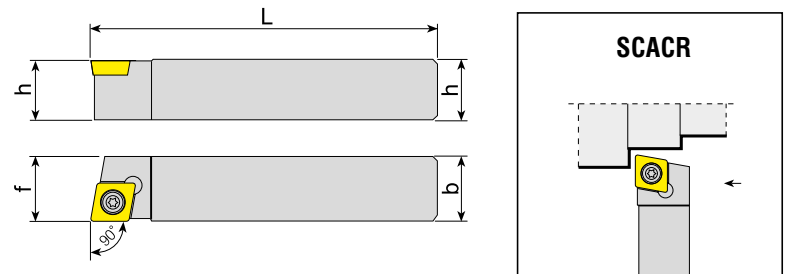

Takım Kodu Ordering Code Код для заказа	Stok Stock Наличие		Takım Ölçüleri (mm) Dimension (mm) Размеры (мм)				Kesici Uç Insert Пластина	Yedek Parçaları / Spare Parts / Запасные части			
	R	L	h	b	L	f		Sıkma Vidası Screw Зажимной винт	Altlık Shim Опорная пластина	Altlık Vidası Shim Screw Винт опорной пластины	Tork Anahtar Torx Key Торх Ключ
SCACR/L 0808 X06-S	●	●	08	08	115	08	CCM. 0602..	4008-M2.5x6	-	-	80-T08
1010 K06-S	●	○	10	10	125	10					
1212 G06-S	●	○	12	12	90	12					
1212 K06-S	●	○	12	12	125	12					
1616 F06-S	○	○	16	16	75	16					
1616 K06-S	○	○	16	16	125	16	CCM. 09T3..	4015-M3.5x11	-	-	80-T15
1212 G09-S	○	○	12	12	90	12					
1212 K09-S	●	●	12	12	125	12					
1616 F09-S	○	○	16	16	75	16					
1616 K09-S	●	●	16	16	125	16					
2020 K09-S	●	●	20	20	125	20					

R: Sağ / Right / Правый L: Sol/Left/Левый
● Stokta / In Stock / В наличии ○ Stokta Yok / Non Stock Item / Нет в наличии

Sipariş Örneği/Ordering Example/Образец заказа
1 ad./pcs./шт SVVCN 1212 F11

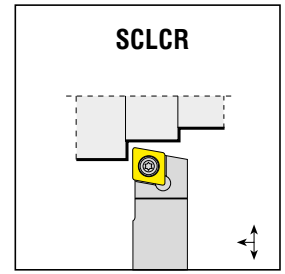
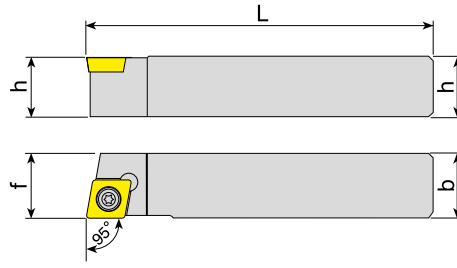

Takım Kodu
Ordering Code
Код для заказа

Stok
Stock
Наличие

Takım Ölçüleri (mm)
Dimension (mm)
Размеры (мм)

Kesici Uç
Insert
Пластина

Sıkma Vidası
Screw
Зажимной винт

Altık
Shim
Опорная пластина

Altık Vidası
Shim Screw
Винт опорной пластины

Tork Anahtar
Torx Key
Торх Ключ

R L h b L f



Takım Kodu Ordering Code Код для заказа	R	L	h	b	L	f
SCLCR/L 0808 X06-S	●	●	08	08	115	08
1010 X06-S	●	○	10	10	115	10
1212 G06-S	○	○	12	12	90	12
1212 X06-S	●	○	12	12	130	12
1212 K06-S	○	●	12	12	125	12
1616 F06-S	●	○	16	16	75	16
1616 X06-S	●	○	16	16	130	16
1212 G09-S	●	○	12	12	90	12
1212 X09-S	●	○	12	12	130	12
1616 F09-S	●	○	16	16	75	16
1616 G09-S	●	○	16	16	90	16
1616 X09-S	●	○	16	16	130	16
2020 X09-S	●	○	20	20	120	20

CCM. 0602..

4008-M2.5x6

80-T08

CCM. 09T3..

4015-M3.5x11

80-T15

Yedek Parçaları / Spare Parts / Запасные части

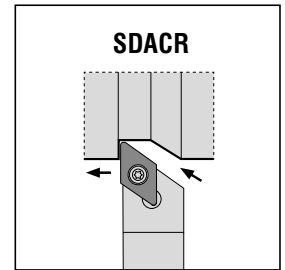
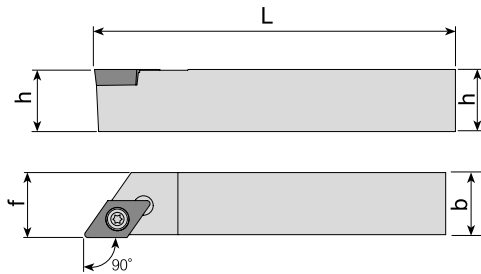

Takım Kodu
Ordering Code
Код для заказа

Stok
Stock
Наличие

Takım Ölçüleri (mm)
Dimension (mm)
Размеры (мм)

Kesici Uç
Insert
Пластина

Sıkma Vidası
Screw
Зажимной винт

Altık
Shim
Опорная пластина

Altık Vidası
Shim Screw
Винт опорной пластины

Tork Anahtar
Torx Key
Торх Ключ

R L h b L f



Takım Kodu Ordering Code Код для заказа	R	L	h	b	L	f
SDACR/L 0808 X07-S	●	●	08	08	115	08
1010 K07-S	●	○	10	10	125	10
1212 G07-S	○	○	12	12	90	12
1212 K07-S	●	○	12	12	125	12
1616 F07-S	○	○	16	16	75	16
1616 K07-S	●	○	16	16	125	16
1212 G11-S	○	○	12	12	90	12
1212 K11-S	●	○	12	12	125	12
1616 F11-S	●	○	16	16	75	16
1616 K11-S	●	○	16	16	125	16
2020 K11-S	●	○	20	20	125	20

DC.T 0702..

4008-M2.5x6

80-T08

DC.T 11T3..

4015-M3.5x11

80-T15

Yedek Parçaları / Spare Parts / Запасные части

R: Sağ / Right / Правый L: Sol/Left/Левый
● Stokta / In Stock / В наличии ○ Stokta Yok / Non Stock Item / Нет в наличии

Sipariş Örneği/Ordering Example/Образец заказа
1 ad./pcs./шт SCLCR 0808 X06-S



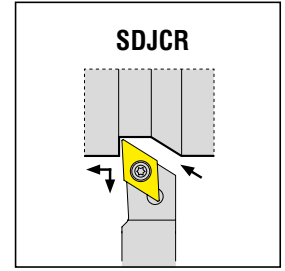
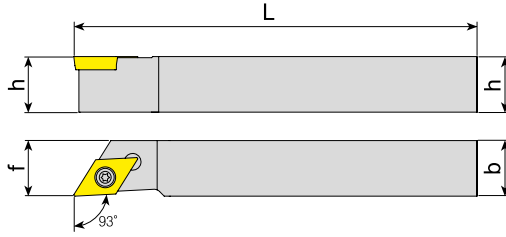
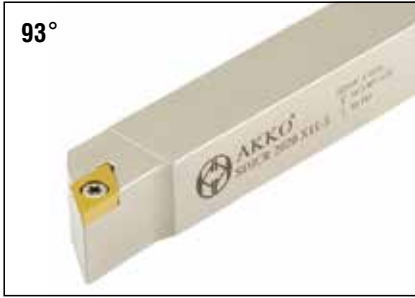

Takım Kodu Ordering Code Код для заказа	Stok Stock Наличие		Takım Ölçüleri (mm) Dimension (mm) Размеры (мм)				Kesici Uç Insert Пластина	Yedek Parçaları / Spare Parts / Запасные части			
	R	L	h	b	L	f		Sikma Vidası Screw Зажимной винт	Aitlik Shim Опорная пластина	Aitlik Vidası Shim Screw Винт опорной пластины	Tork Anahtar Torx Key Торх Ключ
SDJCR/L 0808 X07-S	●	○	08	08	115	08	DC.T 0702..	4008-M2.5x6	-	-	80-T08
1010 X07-S	●	●	10	10	115	10					
1212 G07-S	●	○	12	12	90	12					
1212 X07-S	●	●	12	12	130	12					
1616 F07-S	●	○	16	16	75	16					
1616 X07-S	●	○	16	16	130	16					
2020 X07-S	●	○	20	20	120	20	DC.T 11T3..	4015-M3.5x11	-	-	80-T15
1212 G11-S	●	○	12	12	90	12					
1212 X11-S	●	●	12	12	130	12					
1212 K11-S	●	●	12	12	125	12					
1616 F11-S	●	○	16	16	75	16					
1616 X11-S	●	●	16	16	130	16					
1616 K11-S	●	●	16	16	125	16					
2020 X11-S	●	○	20	20	120	20					

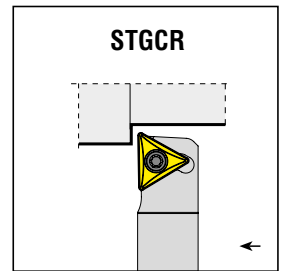
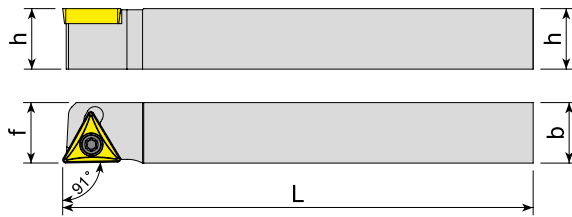





Takım Kodu Ordering Code Код для заказа	Stok Stock Наличие		Takım Ölçüleri (mm) Dimension (mm) Размеры (мм)				Kesici Uç Insert Пластина	Yedek Parçaları / Spare Parts / Запасные части			
	R	L	h	b	L	f		Sikma Vidası Screw Зажимной винт	Aitlik Shim Опорная пластина	Aitlik Vidası Shim Screw Винт опорной пластины	Tork Anahtar Torx Key Торх Ключ
STGCR/L 1216 K11-S	●	○	12	16	125	16	TC.T 1102..	4008-M2.5x6	-	-	80-T08
1616 K11-S	●	○	16	16	125	16					
1216 K16-S	●	○	12	16	125	16	TC.T 16T3..	4015-M3.5x11	-	-	80-T15
1616 K16-S	●	○	16	16	125	16					

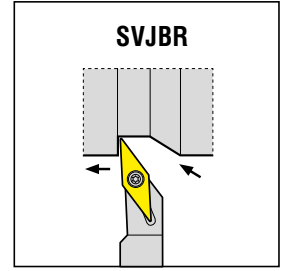
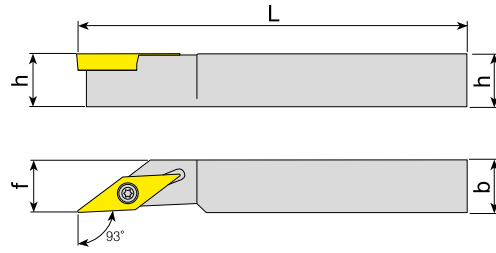

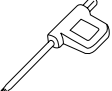

R: Sağ / Right / Правый L: Sol/Left/Левый
● Stokta / In Stock / В наличии ○ Stokta Yok / Non Stock Item / Нет в наличии

Sipariş Örneği/Ordering Example/Образец заказа
1 ad./pcs./шт SDJCR 0808 X07-S

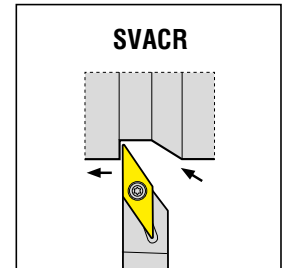
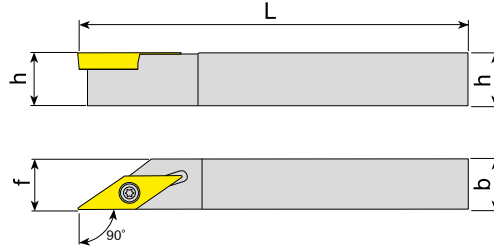

Takım Kodu Ordering Code Код для заказа	Stok Stock Наличие		Takım Ölçüleri (mm) Dimension (mm) Размеры (мм)				Kesici Uç Insert Пластина	Yedek Parçaları / Spare Parts / Запасные части			
	R	L	h	b	L	f		Sıkma Vidası Screw Зажимной винт	Altlık Shim Опорная пластина	Altlık Vidası Shim Screw Винт опорной пластины	Tork Anahtar Torx Key Торх Ключ
SVJBR/L 1616 K11-S	●	●	16	16	125	16					
							VBM. 1103..	4008-M2.5x6	-	-	80-T08



Takım Kodu Ordering Code Код для заказа	Stok Stock Наличие		Takım Ölçüleri (mm) Dimension (mm) Размеры (мм)				Kesici Uç Insert Пластина	Yedek Parçaları / Spare Parts / Запасные части			
	R	L	h	b	L	f		Sıkma Vidası Screw Зажимной винт	Altlık Shim Опорная пластина	Altlık Vidası Shim Screw Винт опорной пластины	Tork Anahtar Torx Key Торх Ключ
SVACR/L 0808 X11-S	○	○	08	08	115	08					
1010 K11-S	●	○	10	10	125	10					
1212 G11-S	○	○	12	12	90	12					
1212 K11-S	●	●	12	12	125	12					
1616 F11-S	○	○	16	16	75	16					
1616 K11-S	●	●	16	16	125	16					
2020 K11-S	●	●	20	20	125	20	VC.T 1103..	4008-M2.5x6	-	-	80-T08
1212 K16-S	●	●	12	12	125	12					
1616 K16-S	●	●	16	16	125	16					
							VC.T 1604..	4015-M3.5x11			80-T15

R: Sağ / Right / Правый L: Sol/Left/Левый
 ● Stokta / In Stock / В наличии ○ Stokta Yok / Non Stock Item / Нет в наличии

Sipariş Örneği/Ordering Example/Образец заказа
 1 ad./pcs./шт SVJBR 1616 K11-S

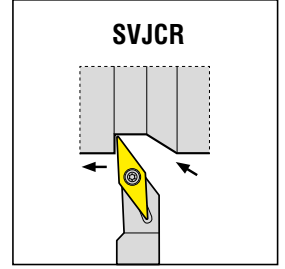
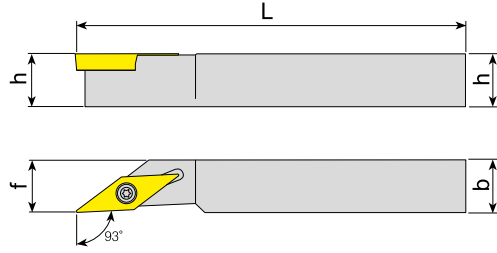

Takım Kodu Ordering Code Код для заказа	Stok Stock Наличие		Takım Ölçüleri (mm) Dimension (mm) Размеры (мм)				Kesici Uç Insert Пластина	Yedek Parçaları / Spare Parts / Запасные части			
	R	L	h	b	L	f		Sıkma Vidası Screw Зажимной винт	Aitlik Shim Опорная пластина	Aitlik Vidası Shim Screw Винт опорной пластины	Tork Anahtar Torx Key Торх Ключ
SVJCR/L 0808 X11-S	●	○	08	08	115	08	VC.T 1103..	4008-M2.5x6	-	-	80-T08
1010 K11-S	●	○	10	10	125	10					
1212 G11-S	○	○	12	12	90	12					
1212 K11-S	●	●	12	12	125	12					
1616 F11-S	○	○	16	16	75	16					
1616 K11-S	●	○	16	16	125	16					
2020 K11-S	○	○	20	20	125	20					

R: Sağ / Right / Правый L: Sol/Left/Левый
 ● Stokta / In Stock / В наличии ○ Stokta Yok / Non Stock Item / Нет в наличии

Sipariş Örneği/Ordering Example/Образец заказа
 1 ad./pcs./шт SVJCR 0808 X11-S



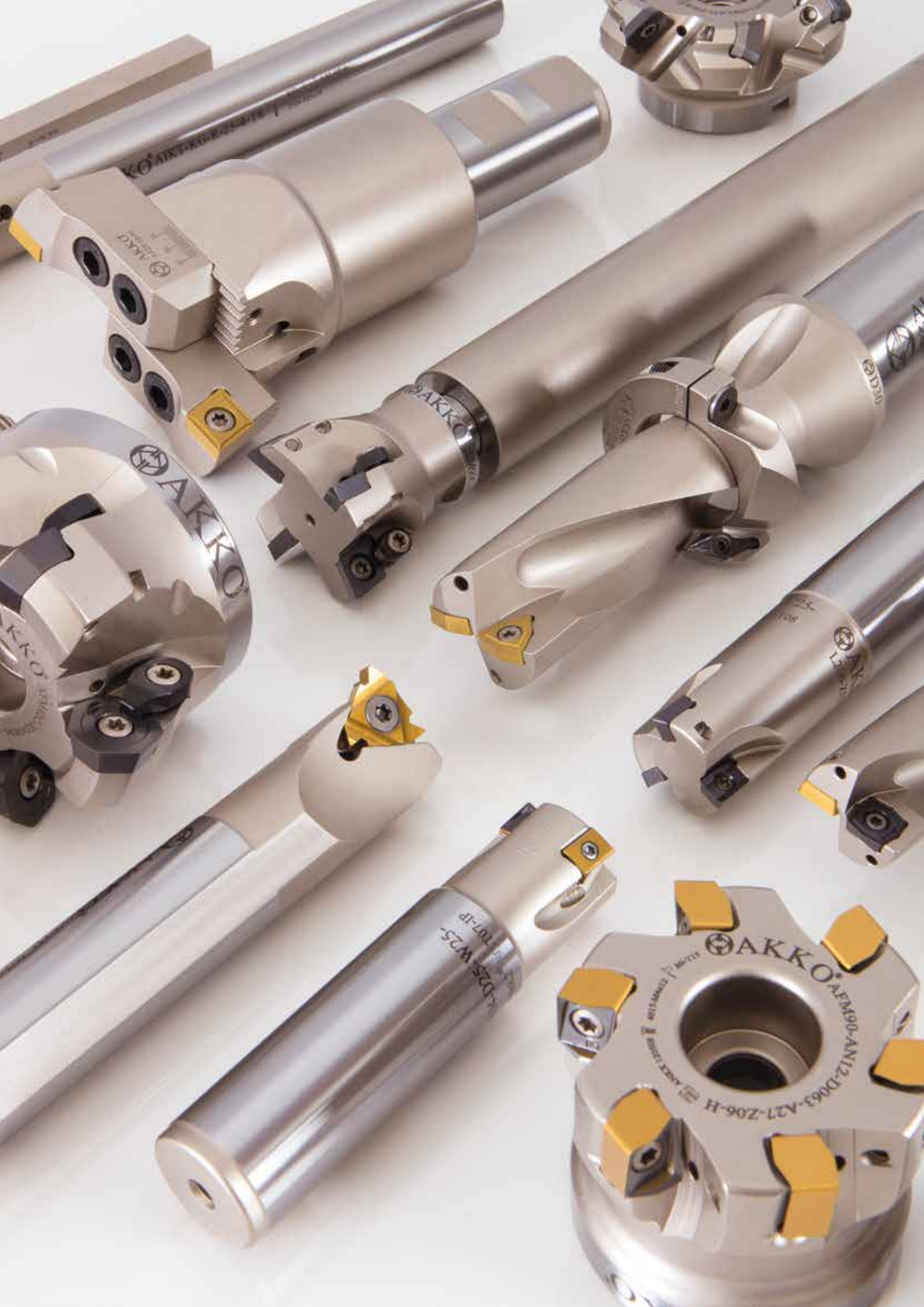

DELİK TORNA TAKIMLARI
INTERNAL TURNING TOOLHOLDERS
РАСТОЧНЫЕ ДЕРЖАВКИ





1 Takım Malzemesi / Type of Boring Bar / Тип скучного бара вставки

"A" Yekpare çelik gövde soğutma suyu kanallı / "A" Solid steel with coolant hole
 "A" Расточная державка из твердой стали с подводом СОЖ
 "E" Çelik başlıkta sert metal gövde ve soğutma suyu kanallı / "E" Carbide bar with fixed steel head and coolant hole
 "E" Расточная державка из твердосплавного карбида с подводом СОЖ
 "C" Karbür Şaft / "C" Carbide shank / "C" Расточная державка из твердосплавного карбида
 "S" Çelik Şaft / "S" Steel shank / "S" Расточная державка из твердой стали

2 Şaft Çapı / Shank Diameter / Диаметр хвостовика

3 Şaft Boyu / Shank Length / Длина хвостовика

A - 32	H - 100	Q - 180	x-special
B - 40	J - 110	R - 200	
C - 50	K - 125	S - 250	
D - 60	L - 140	T - 300	
E - 70	M - 150	U - 350	
F - 80	N - 160	V - 400	
G - 90	P - 170	W - 450	

(mm)

4 Sıkma Tipi / Method of Mounting of Insert / Способ монтажа вставки

Deliksiz Üstten Sıkma Top Clamping Without Hole Прижим сверху без отверстия	Üstten Delikli Sıkma Top and Hole Clamping Прижим сверху с отверстием	Üstten ve Delikten Sıkma Top and Hole Clamping Прижим сверху и поджим за отверстие	Delikten Levye ile Sıkma Hole Clamping (Lever Lock) Прижим рычагом за отверстие	Vida ile Sıkma Screw on Крепление винтом
C	T	M	P	S

5 Uç Tipi / Type of Insert / Форма пластины

C	D	E
V	R	S
W	K	T

6 Yanaşma Açısı / Tool Holder Shape Bar Geometry / Угол направления

7 Serbest Uç Açısı / Insert Clearance Angle / Задний угол пластины

8 Kesme Yönü / Cutting Direction / Направление резания

9 Kesme Kenar Uzunluğu / Cutting Edge Length / Длина режущей кромки

10 Baskı Pabucu / Wedge Clamp / Крепление СМП прихватом

T&C-SİSTEM

T&C SİSTEM DELİK TORNA KATERLERİ
T&C SYSTEM BORING BARS
T И C-ТИП РАСТОЧНЫЕ ДЕРЖАВКИ

konusulan
the spoken kalite...
quality...



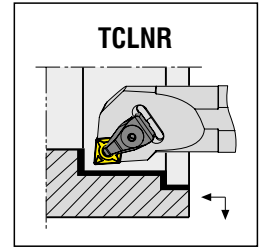
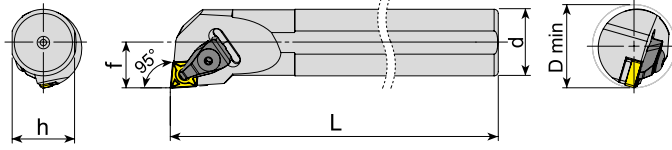

Takım Kodu Ordering Code Код для заказа	Stok Stock Наличие		Takım Ölçüleri (mm) Dimension (mm) Размеры (мм)				Kesici Uç Insert Пластина	Yedek Parçaları / Spare Parts / Запасные части							
	R	L	d	h	L	f		D min	Baskı Pabucu Wedge Clamp Прижим	Pabuç Vidası Clamp Screw Винт прижима	Altlık Shim Опорная пластина	Altlık Vidası Shim Screw Винт опорной пластины	Sekman Ring Кольцо	Pul Stamp Шайба	Anahtar Allen Key Ключ
S25S TCLNR/L 09	●	●	25	23	250	17	≥32	CNM. 0903..	ATK-01	AKV-01-M5x22	AACN-2-0001	AAV-09-M5x9	-		
S25S TCLNR/L 12	●	●	25	23	250	17	≥32					AAV-13-M5x8			
S32T TCLNR/L 12	●	●	32	30	300	22	≥40	CNM. 1204..	ATK-02	AKV-30-M6x22	AACN-3-0001	AAV-02-M5x12	AS-01	ABPL-01	AAL-03-3
S40U TCLNR/L 12	●	●	40	37.5	350	27	≥50								
S50V TCLNR/L 12	●	●	50	47	400	35	≥63								
S32T TCLNR/L 16	●	●	32	30	300	22	≥40								
S40U TCLNR/L 16	●	●	40	37.5	350	27	≥50	CNM. 1606..	ATK-04	AKV-19-M7x25	AACN-3-0002	AAV-05-M6x15	-	ABPL-02	AAL-05-4
S50V TCLNR/L 16	●	●	50	47	400	35	≥63								

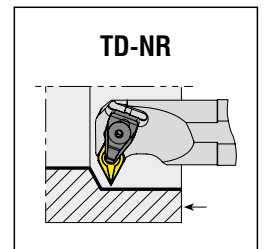
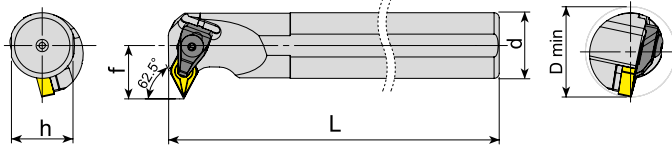

Takım Kodu Ordering Code Код для заказа	Stok Stock Наличие		Takım Ölçüleri (mm) Dimension (mm) Размеры (мм)				Kesici Uç Insert Пластина	Yedek Parçaları / Spare Parts / Запасные части							
	R	L	d	h	L	f		D min	Baskı Pabucu Wedge Clamp Прижим	Pabuç Vidası Clamp Screw Винт прижима	Altlık Shim Опорная пластина	Altlık Vidası Shim Screw Винт опорной пластины	Sekman Ring Кольцо	Pul Stamp Шайба	Anahtar Allen Key Ключ
S32T TD-NR/L 15	●	●	32	30	300	26	≥44								
S40U TD-NR/L 15	●	●	40	37.5	350	29	≥52	DNM. 1506..	ATK-02	AKV-30-M6x22	AADN-3-0001	AAV-02-M5x12	AS-01	ABPL-01	AAL-03-3
S50V TD-NR/L 15	●	●	50	47	400	35	≥63								

R: Sağ / Right / Правый L: Sol/Left/Левый

● Stokta / In Stock / В наличии ○ Stokta Yok / Non Stock Item / Нет в наличии

Sipariş Örneği/Ordering Example/Образец заказа

1 ad./pcs./шт S25S TCLNR 09

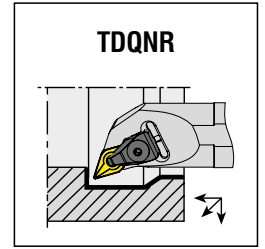
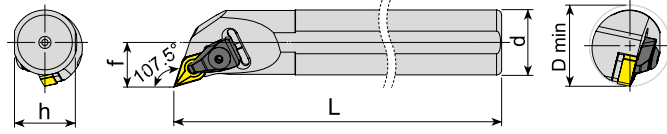

Takım Kodu Ordering Code Код для заказа	Stok Stock Наличие		Takım Ölçüleri (mm) Dimension (mm) Размеры (мм)					Kesici Uç Insert Пластина	Yedek Parçaları / Spare Parts / Запасные части						
	R	L	d	h	L	f	D min		Baskı Pabucu Wedge Clamp Прижим	Pabuç Vidası Clamp Screw Винт прижима	Altık Shim Опорная пластина	Altık Vidası Shim Screw Винт опорной пластины	Sekman Ring Кольцо	Pul Stamp Шайба	Anahtar Allen Key Ключ
S25S TDQNR/L 11	●	●	25	23	250	17	≥32	DNM. 1104..	ATK-01	AKV-01-M5x22	AADN-2-0001	AAV-09-M5x9	-	ABPL-01	AAL-03-3
S32T TDQNR/L 11	●	●	32	30	300	22	≥40					AAV-04-M5x12			
S25S TDQNR/L 15	●	●	25	23	250	17	≥32	DNM. 1506..	ATK-02	AKV-30-M6x22	AADN-3-0001	AAV-13-M5x8	AS-01	ABPL-01	AAL-03-3
S32T TDQNR/L 15	●	●	32	30	300	22	≥40					AAV-02-M5x12			
S40U TDQNR/L 15	●	●	40	37.5	350	27	≥50								
S50V TDQNR/L 15	●	●	50	47	400	35	≥63								

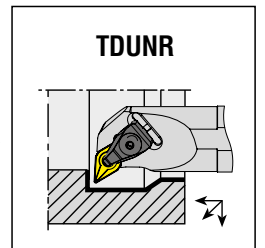
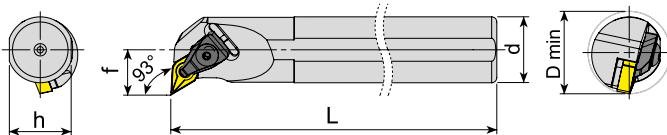

Takım Kodu Ordering Code Код для заказа	Stok Stock Наличие		Takım Ölçüleri (mm) Dimension (mm) Размеры (мм)					Kesici Uç Insert Пластина	Yedek Parçaları / Spare Parts / Запасные части						
	R	L	d	h	L	f	D min		Baskı Pabucu Wedge Clamp Прижим	Pabuç Vidası Clamp Screw Винт прижима	Altık Shim Опорная пластина	Altık Vidası Shim Screw Винт опорной пластины	Sekman Ring Кольцо	Pul Stamp Шайба	Anahtar Allen Key Ключ
S25S TDUNR/L 11	●	●	25	23	250	17	≥32	DNM. 1104..	ATK-01	AKV-01-M5x22	AADN-2-0001	AAV-09-M5x9	-	ABPL-01	AAL-03-3
S32T TDUNR/L 11	●	●	32	30	300	22	≥40					AAV-04-M5x12			
S25S TDUNR/L 15	●	●	25	23	250	17	≥34	DNM. 1506..	ATK-02	AKV-30-M6x22	AADN-3-0001	AAV-13-M5x8	AS-01	ABPL-01	AAL-03-3
S32T TDUNR/L 15	●	●	32	30	300	22	≥40					AAV-02-M5x12			
S40U TDUNR/L 15	●	●	40	37.5	350	27	≥50								
S50V TDUNR/L 15	●	●	50	47	400	35	≥63								

R: Sağ / Right / Правый L: Sol/Left/Левый
● Stokta / In Stock / В наличии ○ Stokta Yok / Non Stock Item / Нет в наличии

Sipariş Örneği/Ordering Example/Образец заказа
1 ad./pcs./шт S25S TDQNR 11

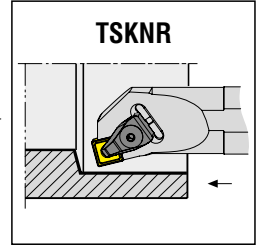
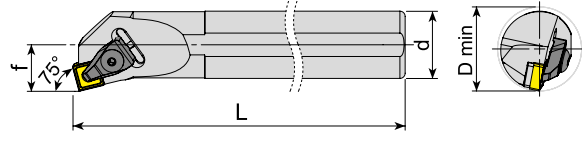
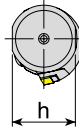

Takım Kodu Ordering Code Код для заказа	Stok Stock Наличие		Takım Ölçüleri (mm) Dimension (mm) Размеры (мм)				Kesici Uç Insert Пластина	Baskı Pabucu Wedge Clamp Прижим	Pabuç Vidası Clamp Screw Винт прижима	Altlık Shim Опорная пластина	Altlık Vidası Shim Screw Винт опорной пластины	Sekman Ring Кольцо	Pul Stamp Шайба	Anahtar Allen Key Ключ	
	R	L	d	h	L	f									D min
S25S TSKNR/L 12	●	●	25	23	250	17	≥32	SNM. 1204..	ATK-02	AKV-30-M6x22	AASN-3-0004	AAV-13-M5x8	AS-01	ABPL-01	AAL-03-3
S32T TSKNR/L 12	●	●	32	30	300	22	≥40								
S40U TSKNR/L 12	●	●	40	37.5	350	27	≥50								

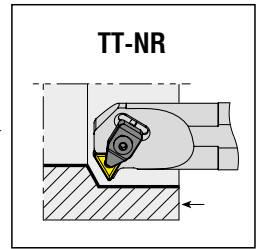
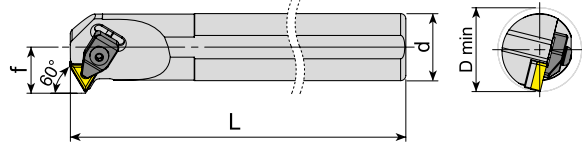
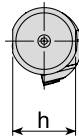

Takım Kodu Ordering Code Код для заказа	Stok Stock Наличие		Takım Ölçüleri (mm) Dimension (mm) Размеры (мм)				Kesici Uç Insert Пластина	Baskı Pabucu Wedge Clamp Прижим	Pabuç Vidası Clamp Screw Винт прижима	Altlık Shim Опорная пластина	Altlık Vidası Shim Screw Винт опорной пластины	Yay Spring Пружина	Pul Stamp Шайба	Anahtar Allen Key Ключ	
	R	L	d	h	L	f									D min
S25S TT-NR/L 16	●	●	25	23	250	17	≥32	TNM. 1604..	ATK-01	AKV-01-M5x22	AATN-2-0002	AAV-03-M5x12	-	ABPL-01	AAL-03-3
S32T TT-NR/L 16	●	●	32	30	300	22	≥40								

R: Sağ / Right / Правый L: Sol/Left/Левый

● Stokta / In Stock / В наличии ○ Stokta Yok / Non Stock Item / Нет в наличии

Sipariş Örneği/Ordering Example/Образец заказа

1 ad./pcs./шт S25S TSKNR 12

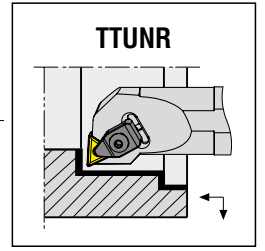
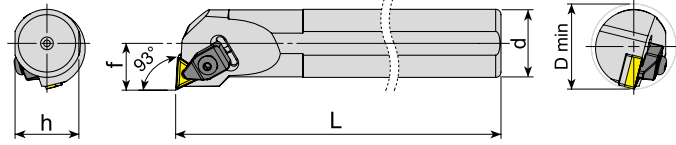

Takım Kodu Ordering Code Код для заказа	Stok Stock Наличие		Takım Ölçüleri (mm) Dimension (mm) Размеры (мм)				Kesici Uç Insert Пластина	Yedek Parçaları / Spare Parts / Запасные части							
	R	L	d	h	L	f		D min	Baskı Pabucu Wedge Clamp Прижим	Pabuç Vidası Clamp Screw Винт прижима	Altlık Shim Опорная пластина	Altlık Vidası Shim Screw Винт опорной пластины	Sekman Ring Кольцо	Pul Stamp Шайба	Anahtar Allen Key Ключ
S25S TTUNR/L 16	●	●	25	23	250	17	≥32	TNM. 1604..	ATK-01	AKV-01-M5x22	AATN-2-0002	AAV-03-M5x12	-	ABPL-01	AAL-03-3
S32T TTUNR/L 16	●	●	32	30	300	22	≥40								
S25S TTUNR/L 22	●	●	25	23	250	17	≥32	TNM. 2204..	ATK-02	AKV-30-M6x22	AATN-3-0015	AAV-02-M5x12	AS-01	ABPL-01	AAL-03-3
S32T TTUNR/L 22	●	●	32	30	300	22	≥40								
S40U TTUNR/L 22	●	●	40	37.5	350	27	≥50								
S50V TTUNR/L 22	●	●	50	47	400	35	≥63								

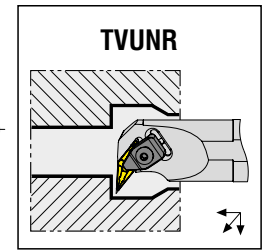
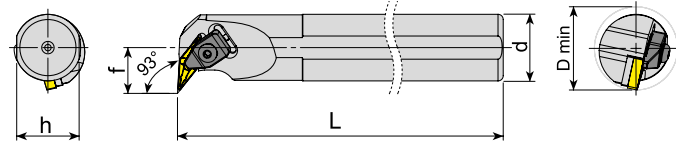

Takım Kodu Ordering Code Код для заказа	Stok Stock Наличие		Takım Ölçüleri (mm) Dimension (mm) Размеры (мм)				Kesici Uç Insert Пластина	Yedek Parçaları / Spare Parts / Запасные части							
	R	L	d	h	L	f		D min	Baskı Pabucu Wedge Clamp Прижим	Pabuç Vidası Clamp Screw Винт прижима	Altlık Shim Опорная пластина	Altlık Vidası Shim Screw Винт опорной пластины	Yay Spring Пружина	Pul Stamp Шайба	Anahtar Allen Key Ключ
S25S TVUNR/L 16	●	●	25	23	250	20	≥36	VNM. 1604..	ATK-01	AKV-01-M5x22	AAVN-2-0002	AAV-04-M5x12	-	ABPL-01	AAL-03-3
S32T TVUNR/L 16	●	●	32	30	300	22	≥40								
S40U TVUNR/L 16	●	●	40	37.5	350	27	≥50								

R: Sağ / Right / Правый L: Sol/Left/Левый

● Stokta / In Stock / В наличии ○ Stokta Yok / Non Stock Item / Нет в наличии

Sipariş Örneği/Ordering Example/Образец заказа

1 ad./pcs./шт S25S TTUNR 16

T-SİSTEM DELİK TORNA KATERLERİ
T-SYSTEM BORING BARS
T-ТИП РАСТОЧНЫЕ ДЕРЖАВКИ

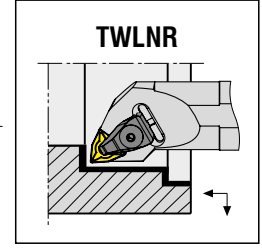
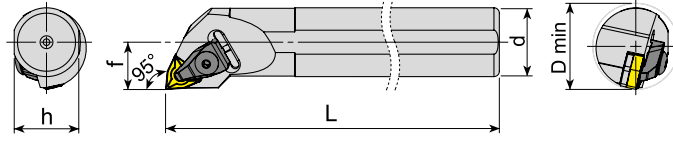

Takım Kodu Ordering Code Код для заказа	Stok Stock Наличие		Takım Ölçüleri (mm) Dimension (mm) Размеры (мм)				Kesici Uç Insert Пластина	Baskı Pabucu Wedge Clamp Прижим	Pabuç Vidası Clamp Screw Винт прижима	Yedek Parçaları / Spare Parts / Запасные части		Sekman Ring Кольцо	Pul Stamp Шайба	Anahtar Allen Key Ключ								
	R	L	d	h	L	f				D min	Altık Shim Опорная пластина				Altık Vidası Shim Screw Винт опорной пластины							
S25S TWLNR/L 06	●	●	25	23	250	17	≥32	WNM. 0604..	ATK-01	AKV-01-M5x22	AAWN-SW317	AAV-01-M3x10	-									
S32T TWLNR/L 06	●	●	32	30	300	22	≥40															
S25S TWLNR/L 08	●	●	25	23	250	17	≥32	WNM. 0804..	ATK-02	AKV-30-M6x22	AAWN-3-0001	AAV-02-M5x12	AS-01	ABPL-01	AAL-03-3							
S32T TWLNR/L 08	●	●	32	30	300	22	≥40															
S40U TWLNR/L 08	●	●	40	37.5	350	27	≥50															
S50V TWLNR/L 08	●	●	50	47	400	35	≥63															
A40T TWLNR/L 08	●	○	40	37.5	300	27	≥50															
A50U TWLNR/L 08	●	○	50	47	350	35	≥63															

C-SİSTEM DELİK TORNA KATERLERİ
C-SYSTEM BORING BARS
C-ТИП РАСТОЧНЫЕ ДЕРЖАВКИ

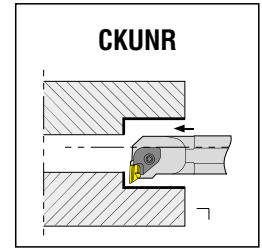
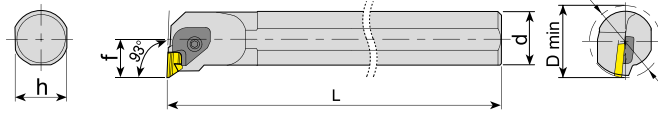

Takım Kodu Ordering Code Код для заказа	Stok Stock Наличие		Takım Ölçüleri (mm) Dimension (mm) Размеры (мм)				Kesici Uç Insert Пластина	Baskı Pabucu Wedge Clamp Прижим	Pabuç Vidası Clamp Screw Винт прижима	Yedek Parçaları / Spare Parts / Запасные части		Yay Spring Пружина	Pul Stamp Шайба	Anahtar Allen Key Ключ								
	R	L	d	h	L	f				D min	Altık Shim Опорная пластина				Altık Vidası Shim Screw Винт опорной пластины							
S25S CKUNR/L 16	●	●	25	23	250	19	≥38	KNUX 1604..	ACK-01-R ACK-02-L	AKV-06-M6x20	AKS-16-R AKS-16-L	AAV-01-M3x10	AKY-02	ABPL-01	AAL-05-4							
S32T CKUNR/L 16	●	●	32	30	300	22	≥40															
S40U CKUNR/L 16	●	●	40	37.5	350	27	≥50															
S50V CKUNR/L 16	●	●	50	47	400	35	≥63															

R: Sağ / Right / Правый L: Sol/Left/Левый
 ● Stokta / In Stock / В наличии ○ Stokta Yok / Non Stock Item / Нет в наличии

Sipariş Örneği/Ordering Example/Образец заказа
 1 ad./pcs./шт S25S TWLNR 06

M-SİSTEM

M-SİSTEM DELİK TORNA KATERLERİ
M-SYSTEM BORING BARS
M-ТИП РАСТОЧНЫЕ ДЕРЖАВКИ

konusulan
the spoken *kalite...*
quality...



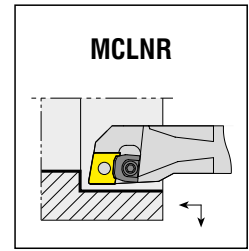
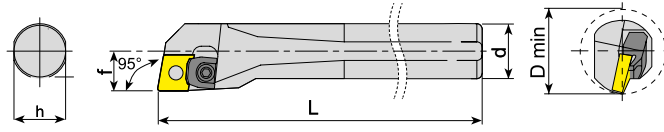

Takım Kodu Ordering Code Код для заказа	Stok Stock Наличие		Takım Ölçüleri (mm) Dimension (mm) Размеры (мм)				Kesici Uç Insert Пластина	Yedek Parçaları / Spare Parts / Запасные части						
	R	L	d	h	L	f		D min	Baskı Pabucu Wedge Clamp Прижим	Pabuç Vidası Clamp Screw Винт прижима	Altık Shim Отверная пластина	Pim Pin Штифт	Pul Stamp Шайба	Anahtar Allen Key Ключ
S20R MCLNR/L 12	●	●	20	18.3	200	13	≥25	CNM. 1204..	AMK-07		-	APM-12		AAL-03-3
S25S MCLNR/L 12	●	●	25	23	250	17	≥32		AMK-03	AKV-04-M5x17	AACN-3-0001	APM-13	-	
S32T MCLNR/L 12	●	●	32	30	300	22	≥40					APM-04		

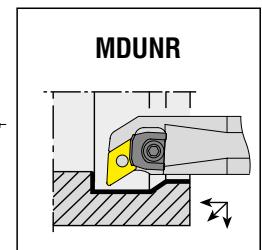
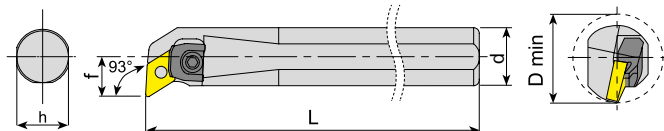

Takım Kodu Ordering Code Код для заказа	Stok Stock Наличие		Takım Ölçüleri (mm) Dimension (mm) Размеры (мм)				Kesici Uç Insert Пластина	Yedek Parçaları / Spare Parts / Запасные части							
	R	L	d	h	L	f		D min	Baskı Pabucu Wedge Clamp Прижим	Pabuç Vidası Clamp Screw Винт прижима	Altık Shim Отверная пластина	Pim Pin Штифт	Sekman Ring Кольцо	Pul Stamp Шайба	Anahtar Allen Key Ключ
S20R MDUNR/L 11	●	●	20	18.3	200	13	≥25	DNM. 1104..		AKV-17-M5x15					AAL-03-3
S25S MDUNR/L 11	●	●	25	23	250	17	≥32		AMK-03	AKV-04-M5x17	-	APM-03	-	-	
S32T MDUNR/L 11	○	○	32	30	300	22	≥40								
S25S MDUNR/L 15	●	●	25	23	250	17	≥32	DNM. 1506..		AKV-20-M6x19					AAL-03-3
S32T MDUNR/L 15	●	●	32	30	300	22	≥40								
S40U MDUNR/L 15	●	●	40	37.5	350	27	≥50		AMK-04	AKV-30-M6x22	AADN-3-0001	APM-04	AS-01	ABPL-01	
S50V MDUNR/L 15	●	●	50	47	400	35	≥63								

R: Sağ / Right / Правый L: Sol/Left/Левый
● Stokta / In Stock / В наличии ○ Stokta Yok / Non Stock Item / Нет в наличии

Sipariş Örneği/Ordering Example/Образец заказа
1 ad./pcs./шт S20R MCLNR 12

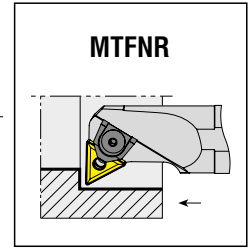
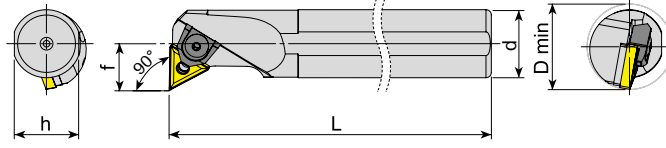

Takım Kodu Ordering Code Код для заказа	Stok Stock Наличие		Takım Ölçüleri (mm) Dimension (mm) Размеры (мм)					Kesici Uç Insert Пластина	Yedek Parçaları / Spare Parts / Запасные части						
	R	L	d	h	L	f	D min		Baskı Pabucu Wedge Clamp Прижим	Pabuç Vidası Clamp Screw Винт прижима	Aftlık Shim Опорная пластина	Pim Pin Штифт	Sekman Ring Кольцо	Pul Stamp Шайба	Anahtar Allen Key Ключ
	●	○													
S20R MTFNR/L 16	●	●	20	18.3	200	14	≥25	TNM. 1604..	AMK-02	AKV-17-M5x15	-	APM-03	-	-	AAL-03-3
S25S MTFNR/L 16	●	●	25	23	250	17	≥32					APM-14			
S32T MTFNR/L 16	●	●	32	30	300	22	≥40				AATN-2-0002	APM-01	AS-01	ABPL-01	
S40U MTFNR/L 16	●	●	40	37.5	350	27	≥50		AMK-04	AKV-30-M6x22					
S32T MTFNR/L 22	●	●	32	30	300	22	≥40	TNM. 2204..			AATN-3-0015	APM-02			
S40U MTFNR/L 22	●	●	40	37.5	350	27	≥50								
S50V MTFNR/L 22	●	○	50	47	400	35	≥63								

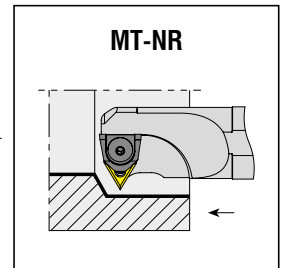
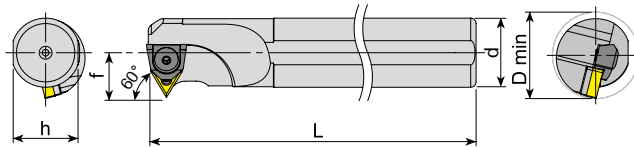

Takım Kodu Ordering Code Код для заказа	Stok Stock Наличие		Takım Ölçüleri (mm) Dimension (mm) Размеры (мм)					Kesici Uç Insert Пластина	Yedek Parçaları / Spare Parts / Запасные части						
	R	L	d	h	L	f	D min		Baskı Pabucu Wedge Clamp Прижим	Pabuç Vidası Clamp Screw Винт прижима	Aftlık Shim Опорная пластина	Pim Pin Штифт	Sekman Ring Кольцо	Pul Stamp Шайба	Anahtar Allen Key Ключ
	●	○													
S20R MT-NR/L 16	●	●	20	18.3	200	16	≥26	TNM. 1604..	AMK-02	AKV-04-M5x17	-	APM-03	-	-	AAL-03-3
S25S MT-NR/L 16	●	●	25	23	250	17	≥32					APM-14			
S32T MT-NR/L 16	●	●	32	30	300	22	≥40				AATN-2-0002	APM-01	AS-01	ABPL-01	
S40U MT-NR/L 16	●	●	40	37.5	350	27	≥50		AMK-04	AKV-30-M6x22					
S32T MT-NR/L 22	●	●	32	30	300	24	≥40	TNM. 2204..			AATN-3-0015	APM-02			
S40U MT-NR/L 22	●	●	40	37.5	350	27	≥50								
S50U MT-NR/L 22	●	○	50	47	350	35	≥63								

R: Sağ / Right / Правый L: Sol/Left/Левый
● Stokta / In Stock / В наличии ○ Stokta Yok / Non Stock Item / Нет в наличии

Sipariş Örneği/Ordering Example/Образец заказа
1 ad./pcs./шт S20R MTFNR 16

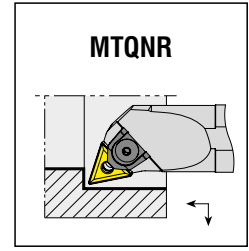
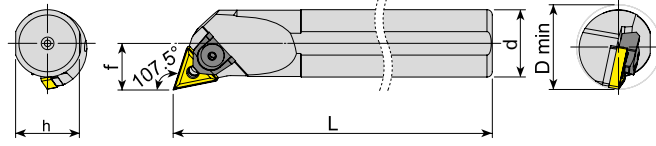

Takım Kodu Ordering Code Код для заказа	Stok Stock Наличие		Takım Ölçüleri (mm) Dimension (mm) Размеры (мм)				Kesici Uç Insert Пластина	Yedek Parçaları / Spare Parts / Запасные части							
	R	L	d	h	L	f		D min	Baskı Pabuçu Wedge Clamp Прижим	Pabuç Vidası Clamp Screw Винт прижима	Altık Shim Оторочная пластина	Pim Pin Штифт	Sekman Ring Кольцо	Pul Stamp Шайба	Anahtar Allen Key Ключ
S20R MTQNR/L 16	●	●	20	18.3	200	13	≥25	TNM. 1604..	AMK-02	AKV-17-M5x15	-	APM-11	-	-	AAL-03-3
S25S MTQNR/L 16	●	●	25	23	250	17	≥32				AATN-2-0002	APM-14			
S32T MTQNR/L 16	●	●	32	30	300	22	≥40					APM-01			
S40U MTQNR/L 16	●	●	40	37.5	350	27	≥50		AMK-04	AKV-30-M6x22			AS-01	ABPL-01	
S32T MTQNR/L 22	●	●	32	30	300	22	≥40	TNM. 2204..			AATN-3-0015	APM-02			
S40U MTQNR/L 22	●	●	40	37.5	350	27	≥50								
S50V MTQNR/L 22	●	●	50	47	400	35	≥63								

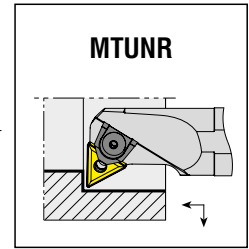
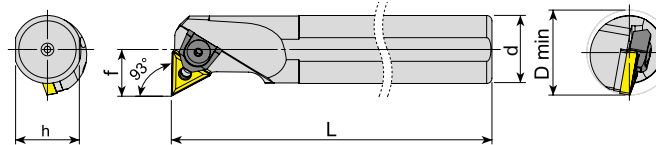

Takım Kodu Ordering Code Код для заказа	Stok Stock Наличие		Takım Ölçüleri (mm) Dimension (mm) Размеры (мм)				Kesici Uç Insert Пластина	Yedek Parçaları / Spare Parts / Запасные части							
	R	L	d	h	L	f		D min	Baskı Pabuçu Wedge Clamp Прижим	Pabuç Vidası Clamp Screw Винт прижима	Altık Shim Оторочная пластина	Pim Pin Штифт	Sekman Ring Кольцо	Pul Stamp Шайба	Anahtar Allen Key Ключ
S20R MTUNR/L 16	●	●	20	18.3	200	13	≥25	TNM. 1604..	AMK-02	AKV-17-M5x15	-	APM-03	-	-	AAL-03-3
S25S MTUNR/L 16	●	●	25	23	250	17	≥32				AATN-2-0002	APM-14			
S32T MTUNR/L 16	●	●	32	30	300	22	≥40					APM-01			
S40U MTUNR/L 16	●	●	40	37.5	350	27	≥50		AMK-04	AKV-30-M6x22			AS-01	ABPL-01	
S50V MTUNR/L 16	●	●	50	47	400	35	≥63	TNM. 2204..			AATN-3-0015	APM-02			
S32T MTUNR/L 22	●	●	32	30	300	22	≥40								
S40U MTUNR/L 22	●	●	40	37.5	350	27	≥50								
S50V MTUNR/L 22	●	●	50	47	400	35	≥63								

R: Sağ / Right / Правый L: Sol/Left/Левый
● Stokta / In Stock / В наличии ○ Stokta Yok / Non Stock Item / Нет в наличии

Sipariş Örneği/Ordering Example/Образец заказа
1 ad./pcs./шт S20R MTQNR 16

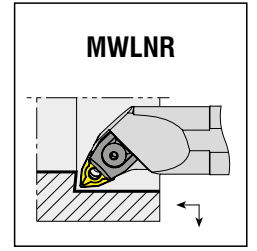
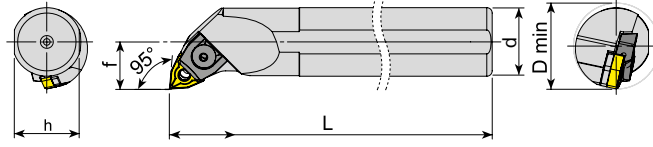

Takım Kodu Ordering Code Код для заказа	Stok Stock Наличие		Takım Ölçüleri (mm) Dimension (mm) Размеры (мм)					Kesici Uç Insert Пластина	Yedek Parçaları / Spare Parts / Запасные части						
	R	L	d	h	L	f	D min		Baskı Pabucu Wedge Clamp Прижим	Pabuç Vidası Clamp Screw Винт прижима	Aitlik Shim Опорная пластина	Sekman Ring Кольцо	Pim Pin Штифт	Pul Stamp Шайба	Anahtar Allen Key Ключ
S16P MWLNR/L 06	●	●	16	14.8	170	11	≥20	WNM. 0604..	AMK-01	AKV-17-M5x15	-	APM-09	-	-	AAL-03-3
S20R MWLNR/L 06	●	●	20	18.3	200	13	≥25					AKV-04-M5x17			
S25S MWLNR/L 06	●	●	25	23	250	17	≥32	WNM. 0804..	AMK-05	AKV-27-M6x20	AAWN-3-0001	APM-08	AS-01	ABPL-01	
S25S MWLNR/L 08	●	●	25	23	250	17	≥32					AKV-03-M6x22			APM-04
S32T MWLNR/L 08	●	●	32	30	300	22	≥40								
S40U MWLNR/L 08	●	●	40	37.5	350	27	≥50								

R: Sağ / Right / Правый L: Sol/Left/Левый
● Stokta / In Stock / В наличии ○ Stokta Yok / Non Stock Item / Нет в наличии

Sipariş Örneği/Ordering Example/Образец заказа
1 ad./pcs./шт S16P MWLNR 06





*konusulan
the spoken kalite...
quality...*

P-SİSTEM

P-SİSTEM DELİK TORNA KATERLERİ

P-SYSTEM BORING BARS

P-ТИП РАСТОЧНЫЕ ДЕРЖАВКИ



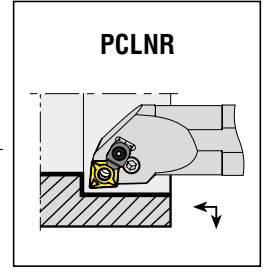
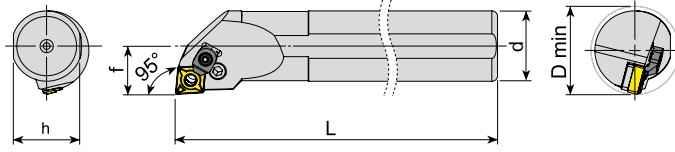

Takım Kodu Ordering Code Код для заказа	Stok Stock Наличие		Takım Ölçüleri (mm) Dimension (mm) Размеры (мм)				Kesici Uç Insert Пластина	Yedek Parçaları / Spare Parts / Запасные части							
	R	L	d	h	L	f		D min	Levyeye Lever Рычаг	Levyeye Vidası Lever Screw Винт рычага	Aitlik Shim Опорная пластина	Aitlik Yay Shim Spring Втулка рычага	Baskı Parçası Wedge Clamp Прижим	Baskı Vidası Clamp Screw Зажимной винт	Anahtar Allen Key Ключ
S16P PCLNR/L 09	●	●	16	14.8	170	11	≥20	CNM. 0903..	APL-07	ALV-07-M6x13	-	AAY-07	-	-	AAL-02-2.5
S20R PCLNR/L 09	●	●	20	18.3	200	13	≥25		APL-01	ALV-02-M6x17	AACN-2-0002	AAY-01	-	-	AAL-02-2.5
S25S PCLNR/L 09	●	○	25	23	250	17	≥32	CNM. 1204..	APL-02	ALV-08-M8x16	AACN-3-0001	AAY-02	ACK-05	4015-M4x11	AAL-03-3
S25S PCLNR/L 12C	●	●	25	23	250	17	≥32			ALV-03-M8x19					
S32T PCLNR/L 12C	●	●	32	30	300	22	≥40	CNM. 1606..	APL-04	ALV-04-M8x22	AACN-3-0002	AAY-03	ACK-09	AAV-05-M6x15	AAL-05-4
S40U PCLNR/L 12C	●	●	40	37.5	350	27	≥50								
S40U PCLNR/L 16C	●	●	40	37.5	350	27	≥50	CNM. 1906..	APL-05	ALV-05-M10x27	AACN-3-0003	AAY-04	ACK-09	AAV-05-M6x15	AAL-05-4
S50V PCLNR/L 12C	●	●	50	47	400	35	≥63								
S32T PCLNR/L 16C	●	●	32	30	300	22	≥40	CNM. 1606..	APL-04	ALV-04-M8x22	AACN-3-0002	AAY-03	ACK-09	AAV-05-M6x15	AAL-05-4
S40U PCLNR/L 16C	●	●	40	37.5	350	27	≥50								
S40U PCLNR/L 19C	●	●	40	37.5	350	27	≥50	CNM. 1906..	APL-05	ALV-05-M10x27	AACN-3-0003	AAY-04	ACK-09	AAV-05-M6x15	AAL-05-4
S50V PCLNR/L 19C	●	●	50	47	400	35	≥63								
A25R PCLNR/L 12C	●	●	25	23	200	17	≥32	CNM. 1204..	APL-02	ALV-03-M8x19	AACN-3-0001	AAY-02	ACK-05	4015-M4x11	AAL-03-3
A32S PCLNR/L 12C	●	●	32	30	250	22	≥40								
A40T PCLNR/L 12C	●	●	40	37.5	300	27	≥50	CNM. 1606..	APL-04	ALV-04-M8x22	AACN-3-0002	AAY-03	ACK-09	AAV-05-M6x15	AAL-05-4
A50U PCLNR/L 12C	●	●	50	47	350	35	≥63								
A32S PCLNR/L 16C	●	●	32	30	250	22	≥40	CNM. 1906..	APL-05	ALV-05-M10x27	AACN-3-0003	AAY-04	ACK-09	AAV-05-M6x15	AAL-05-4
A40T PCLNR/L 16C	●	●	40	37.5	300	27	≥50								
A50U PCLNR/L 16C	●	●	50	47	350	35	≥63	CNM. 1906..	APL-05	ALV-05-M10x27	AACN-3-0003	AAY-04	ACK-09	AAV-05-M6x15	AAL-05-4
A40T PCLNR/L 19C	●	●	40	37.5	300	27	≥50								
A50U PCLNR/L 19C	●	●	50	47	350	35	≥63								

R: Sağ / Right / Правый L: Sol/Left/Левый
● Stokta / In Stock / В наличии ○ Stokta Yok / Non Stock Item / Нет в наличии

Sipariş Örneği/Ordering Example/Образец заказа
1 ad./pcs./шт S16P PCLNR 09

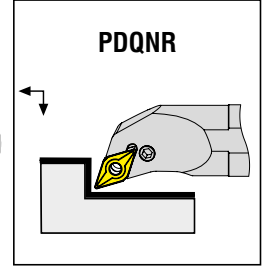
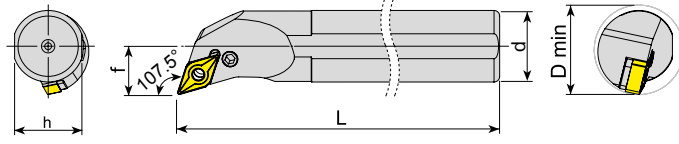

Takım Kodu Ordering Code Код для заказа	Stok Stock Наличие		Takım Ölçüleri (mm) Dimension (mm) Размеры (мм)					Kesici Uç Insert Пластина	Yedek Parçaları / Spare Parts / Запасные части						
	R	L	d	h	L	f	D min		Levye Lever Рычаг	Levye Vidası Lever Screw Винт рычага	Altılık Shim Опорная пластина	Altılık Yay Shim Spring Втулка рычага	Baskı Parçası Wedge Clamp Прижим	Baskı Vidası Clamp Screw Зажимной винт	Anahtar Allen Key Ключ
	●	○													
S20R PDQNR/L 11	●	○	20	18.3	200	13	≥25	DNM. 1104..	APL-01	ALV-01-M6x14 ALV-02-M6x17	AADN-SD317	AAY-01			AAL-02-2.5
S25S PDQNR/L 11	●	●	25	23	250	17	≥32								
S32T PDQNR/L 15	●	●	32	30	300	22	≥40	DNM. 1506..	APL-03	ALV-03-M8x19	AADN-3-0001	AAY-02	-	-	AAL-03-3
S40U PDQNR/L 15	●	●	40	37.5	350	27	≥50								
S50V PDQNR/L 15	●	●	50	47	400	35	≥63	DNM. 1504..	APL-03	ALV-03-M8x19	AADN-2-0003	AAY-02	-	-	AAL-03-3
S32T PDQNR/L 1504	●	●	32	30	300	22	≥40								
S40U PDQNR/L 1504	●	●	40	37.5	350	27	≥50	DNM. 1506..	APL-03	ALV-03-M8x19	AADN-3-0001	AAY-02	-	-	AAL-03-3
S50V PDQNR/L 1504	●	●	50	47	400	35	≥63								
A20P PDQNR/L 11	●	●	20	18.3	170	13	≥25	DNM. 1104..	APL-01	ALV-01-M6x14 ALV-02-M6x17	AADN-SD317	AAY-01	-	-	AAL-02-2.5
A25R PDQNR/L 11	●	●	25	23	200	17	≥32								
A32S PDQNR/L 15	●	●	32	30	250	22	≥40	DNM. 1506..	APL-03	ALV-03-M8x19	AADN-3-0001	AAY-02	-	-	AAL-03-3
A40T PDQNR/L 15	●	●	40	37.5	300	27	≥50								
A50U PDQNR/L 15	●	●	50	47	350	35	≥63	DNM. 1504..	APL-03	ALV-03-M8x19	AADN-2-0003	AAY-02	-	-	AAL-03-3
A32S PDQNR/L 1504	●	●	32	30	250	22	≥40								
A40T PDQNR/L 1504	●	●	40	37.5	300	27	≥50								

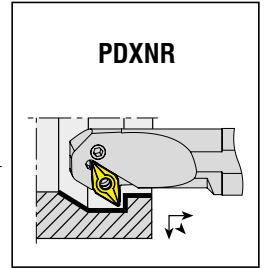
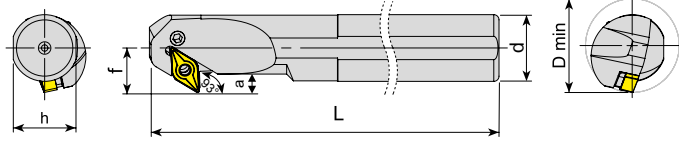

Takım Kodu Ordering Code Код для заказа	Stok Stock Наличие		Takım Ölçüleri (mm) Dimension (mm) Размеры (мм)						Kesici Uç Insert Пластина	Yedek Parçaları / Spare Parts / Запасные части						
	R	L	d	h	L	f	a	D min		Levye Lever Рычаг	Levye Vidası Lever Screw Винт рычага	Altılık Shim Опорная пластина	Altılık Yay Shim Spring Втулка рычага	Baskı Parçası Wedge Clamp Прижим	Baskı Vidası Clamp Screw Зажимной винт	Anahtar Allen Key Ключ
	●	○														
S32T PDXNR/L 15	●	●	32	30	300	22	12	≥45	DNM. 1506..	APL-03	ALV-08-M8x16 ALV-03-M8x19	AADN-3-0001	AAY-02	-	-	AAL-03-3
S40U PDXNR/L 15	●	●	40	37.5	350	27	14	≥50								
S50V PDXNR/L 15	●	●	50	47	400	35	19	≥63								

R: Sağ / Right / Правый L: Sol/Left/ Левый
● Stokta / In Stock / В наличии ○ Stokta Yok / Non Stock Item / Нет в наличии

Sipariş Örneği/Ordering Example/Образец заказа
1 ad./pcs./шт S20R PDQNR 11

Not: "a" ölçüleri R0.8'e göre verilmiştir.
Note: Dimensions of "a" are given according to R.08.
Примечание: размеры должны быть R.08

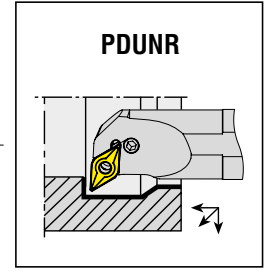
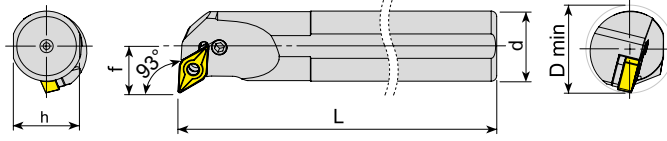

Takım Kodu Ordering Code Код для заказа	Stok Stock Наличие		Takım Ölçüleri (mm) Dimension (mm) Размеры (мм)				Kesici Uç Insert Пластина	Yedek Parçaları / Spare Parts / Залпасные части							
	R	L	d	h	L	f		D min	Levyey Lever Рычаг	Levyey Vidası Lever Screw Винт рычага	Altılık Shim Опорная пластина	Altılık Yayı Shim Spring Втулка рычага	Baskı Parçası Wedge Clamp Прижим	Baskı Vidası Clamp Screw Зажимной винт	Anahtar Allen Key Ключ
S20R PDUNR/L 11	●	●	20	18.3	200	13	≥25	DNM. 1104..	APL-01	ALV-01-M6x14 ALV-02-M6x17	AADN-SD317	AAY-01	-	-	AAL-02-2.5
S25S PDUNR/L 11	●	●	25	23	250	17	≥32								
S25S PDUNR/L 15	●	●	25	23	250	19	≥32	DNM. 1506..	APL-03	ALV-03-M8x19	AADN-3-0001	AAY-02	-	-	AAL-03-3
S32T PDUNR/L 15	●	●	32	30	300	22	≥40								
S40U PDUNR/L 15	●	●	40	37.5	350	27	≥50								
S50V PDUNR/L 15	●	●	50	47	400	35	≥63	DNM. 1104..	APL-01	ALV-01-M6x14 ALV-02-M6x17	AADN-SD317	AAY-01	-	-	AAL-02-2.5
A20P PDUNR/L 11	●	●	20	18.3	170	13	≥25								
A25R PDUNR/L 11	●	●	25	23	200	17	≥32								
A32S PDUNR/L 11	●	●	32	30	250	22	≥40								
A32S PDUNR/L 15	●	●	32	30	250	22	≥40	DNM. 1506..	APL-03	ALV-03-M8x19	AADN-3-0001	AAY-02	-	-	AAL-03-3
A40T PDUNR/L 15	●	●	40	37.5	300	27	≥50								
A50U PDUNR/L 15	●	●	50	47	350	35	≥63								

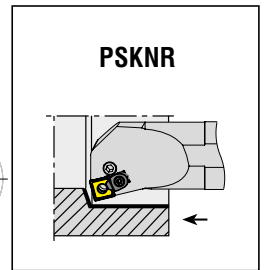
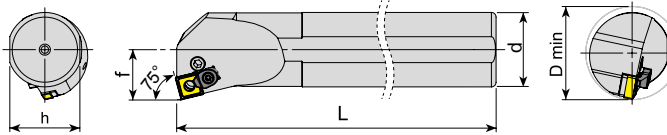

Takım Kodu Ordering Code Код для заказа	Stok Stock Наличие		Takım Ölçüleri (mm) Dimension (mm) Размеры (мм)				Kesici Uç Insert Пластина	Yedek Parçaları / Spare Parts / Залпасные части							
	R	L	d	h	L	f		D min	Levyey Lever Рычаг	Levyey Vidası Lever Screw Винт рычага	Altılık Shim Опорная пластина	Altılık Yayı Shim Spring Втулка рычага	Baskı Parçası Wedge Clamp Прижим	Baskı Vidası Clamp Screw Зажимной винт	Anahtar Allen Key Ключ
S25S PSKNR/L 12C	●	●	25	23	250	17	≥32	SNM. 1204..	APL-02	ALV-08-M8x16 ALV-03-M8x19	AASN-3-0004	AAY-02	ACK-05	4015-M4x11	AAL-03-3
S32T PSKNR/L 12C	●	●	32	30	300	22	≥40								
S40U PSKNR/L 12C	●	●	40	37.5	350	27	≥50								
S50V PSKNR/L 12C	●	●	50	47	400	35	≥63	SNM. 1506..	APL-04	ALV-04-M8x22	AASN-3-0023	AAY-03	-	-	AAL-03-3
S32T PSKNR/L 15	○	○	32	30	300	22	≥40								
S40U PSKNR/L 15	○	○	40	37.5	350	27	≥50								
S50V PSKNR/L 15	○	○	50	47	400	35	≥63								

R: Sağ / Right / Правый L: Sol/Left/Левый
● Stokta / In Stock / В наличии ○ Stokta Yok / Non Stock Item / Нет в наличии

Sipariş Örneği/Ordering Example/Образец заказа
1 ad./pcs./шт S20R PDUNR 11

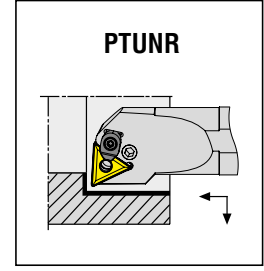
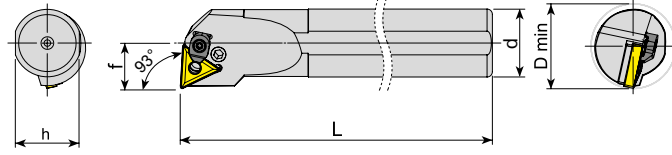

Takım Kodu
Ordering Code
Код для заказа

Stok Stock Наличие	Takım Ölçüleri (mm) Dimension (mm) Размеры (мм)						Kesici Uç Insert Пластина	Yedek Parçaları / Spare Parts / Запасные части							
	R	L	d	h	L	f		D min	Levyeye Lever Рычаг	Levyeye Vidası Lever Screw Винт рычага	Altılık Shim Опорная пластина	Altılık Yayını Shim Spring Втулка рычага	Baskı Parçası Wedge Clamp Прижим	Baskı Vidası Clamp Screw Зажимной винт	Anahtar Allen Key Ключ
●	●	16	14.8	170	11	≥20	TNM. 1604..								
●	●	20	18.3	200	13	≥25									
●	●	25	23	250	17	≥32									
●	●	32	30	300	22	≥40									
●	●	40	37.5	350	27	≥50									
●	●	32	30	300	22	≥40	TNM. 2204..								
●	●	40	37.5	350	27	≥50									
●	●	50	47	400	35	≥63									

R: Sağ / Right / Правый L: Sol/Left/Левый

● Stokta / In Stock / В наличии ○ Stokta Yok / Non Stock Item / Нет в наличии

Sipariş Örneği/Ordering Example/Образец заказа
1 ad./pcs./шт S16P PTUNR 16



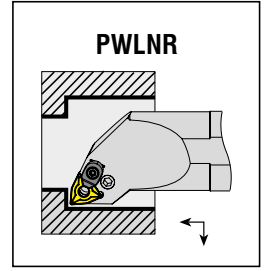
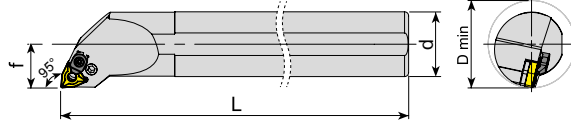
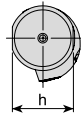

Takım Kodu Ordering Code Код для заказа	Stok Stock Наличие		Takım Ölçüleri (mm) Dimension (mm) Размеры (мм)				Kesici Uç Insert Пластина	Yedek Parçaları / Spare Parts / Запасные части							
	R	L	d	h	L	f		D min	Levyeye Lever Рычаг	Levyeye Vidası Lever Screw Винт рычага	Altılık Shim Опорная пластина	Altılık Yayı Shim Spring Втулка рычага	Baskı Parçası Wedge Clamp Прижим	Baskı Vidası Clamp Screw Зажимной винт	Anahtar Allen Key Ключ
S20R PWLNR/L 06	●	●	20	18.3	200	13	≥25	WNM. 0604..	APL-01	ALV-01-M6x14	AAWN-SW317	AAY-01	-	-	AAL-02-2.5
S25S PWLNR/L 06	●	●	25	23	250	17	≥32								
S32T PWLNR/L 06	●	●	32	30	300	22	≥40								
S25S PWLNR/L 08C	●	●	25	23	250	17	≥32	WNM. 0804..	APL-02	ALV-03-M8x19	AAWN-3-0001	AAY-02	ACK-05	4015-M4x11	AAL-03-3
S32T PWLNR/L 08C	●	●	32	30	300	22	≥40								
S40U PWLNR/L 08C	●	●	40	37.5	350	27	≥50								
S50V PWLNR/L 08C	●	●	50	47	400	35	≥63	WNM. 0604..	APL-01	ALV-01-M6x14	AAWN-SW317	AAY-01	-	-	AAL-02-2.5
A20P PWLNR/L 06	●	●	20	18.3	170	13	≥25								
A25R PWLNR/L 06	●	●	25	23	200	17	≥32								
A32S PWLNR/L 06	●	●	32	30	250	22	≥40	WNM. 0804..	APL-02	ALV-03-M8x19	AAWN-3-0001	AAY-02	ACK-05	4015-M4x11	AAL-03-3
A25R PWLNR/L 08C	●	●	25	23	200	17	≥32								
A32S PWLNR/L 08C	●	●	32	30	250	22	≥40								
A40T PWLNR/L 08C	●	●	40	37.5	300	27	≥50	WNM. 0804..	APL-02	ALV-03-M8x19	AAWN-3-0001	AAY-02	ACK-05	4015-M4x11	AAL-03-3
A50U PWLNR/L 08C	●	●	50	47	350	35	≥63								

R: Sağ / Right / Правый L: Sol/Left/Левый

● Stokta / In Stock / В наличии ○ Stokta Yok / Non Stock Item / Нет в наличии

Sipariş Örneği/Ordering Example/Образец заказа

1 ad./pcs./шт S20R PWLNR 06





*konusulan
the spoken kalite...
quality...*

S-SİSTEM

S-SİSTEM DELİK TORNA KATERLERİ
S-SYSTEM BORING BARS
S-ТИП РАСТОЧНЫЕ ДЕРЖАВКИ



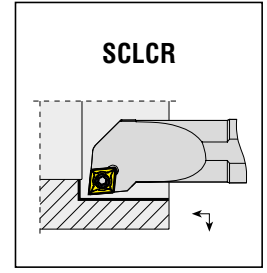
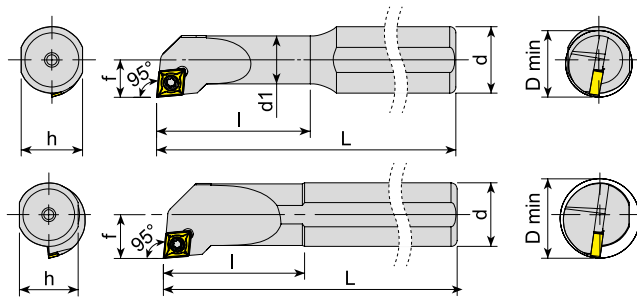

Takım Kodu Ordering Code Код для заказа	Stok Stock Наличие		Takım Ölçüleri (mm) Dimension (mm) Размеры (мм)						Kesici Uç Insert Пластина	Yedek Parçaları / Spare Parts / Запасные части				
	R	L	d	d1	h	l	L	f		D min	Sıkma Vidası Screw Зажимной винт	Altlık Shim Опорная пластина	Altlık Vidası Shim Screw Винт опорной пластины	Tork Anahtar Torx Key Торх Ключ
S0608H SCLCR/L 03	●	○	08	5	7.3	18	100	3	≥6	CC.T 030102	4006-M1.6x3.2			80-T06
S0608H SCLCR/L 06	●	●	08	6	7.3	25	100	4.5	≥8		4008-M2.5x4.5			
S08H SCLCR/L 06	●	●	08	8	7.3	20	100	06	≥11	CC.T 0602..	4008-M2.5x6	-	-	80-T08
S10K SCLCR/L 06	●	●	10	10	09	25	125	07	≥13					
S12K SCLCR/L 06	●	●	12	12	11	25	125	09	≥16					
S1216P SCLCR/L 06	●	●	16	11.5	14.8	37	170	09	≥16					
S16P SCLCR/L 06	●	●	16	16	14.8	35	170	11	≥20	CC.T 09T3..	4015-M3.5x8			80-T15
S12K SCLCR/L 09	●	●	12	12	11	30	125	09	≥16					
S1416P SCLCR/L 09	●	●	16	14	14.8	45	170	9.5	≥17					
S16P SCLCR/L 09	●	●	16	16	14.8	35	170	11	≥20					
S1620R SCLCR/L 09	●	●	20	16	18.3	50	200	11	≥20	CC.T 1204..	4015-M3.5x12	AACN-2-0001	AAV-08-M3.5x8	80-T20
S20R SCLCR/L 09	●	●	20	20	18.3	40	200	13	≥25		4020-M4.5x12	AACN-2-0003	AAV-10-M4.5x8	
S25S SCLCR/L 09	●	●	25	25	23	50	250	17	≥32	1020-M4.5x16		AAV-07-M4.5x13		
S32T SCLCR/L 09	●	●	32	32	30	60	300	22	≥40	CC.T 0602..	4008-M2.5x6	-	-	80-T08
S25S SCLCR/L 12	●	●	25	25	23	50	250	17	≥32					
S32T SCLCR/L 12	●	●	32	32	30	60	300	22	≥40	CC.T 09T3..	4015-M3.5x9	-	-	80-T15
S40U SCLCR/L 12	●	●	40	40	37.5	70	350	27	≥50					
A08H SCLCR/L 06	●	●	08	8	7.3	20	100	06	≥11					
A10H SCLCR/L 06	●	●	10	10	09	25	100	07	≥13					
A12H SCLCR/L 06	●	●	12	12	11	25	100	09	≥16	CC.T 1204..	4020-M4.5x12	AACN-2-0003	AAV-10-M4.5x8	80-T20
A16M SCLCR/L 09	●	●	16	16	14.8	35	150	11	≥20					
A20P SCLCR/L 09	●	●	20	20	18.3	40	170	13	≥25	CC.T 09T3..	4015-M3.5x12	AACN-2-0001	AAV-08-M3.5x8	80-T15
A25R SCLCR/L 09	●	●	25	25	23	50	200	17	≥32					
A32S SCLCR/L 09	●	●	32	32	30	60	250	22	≥40	CC.T 1204..	4020-M4.5x12	AACN-2-0003	AAV-10-M4.5x8	80-T20
A25R SCLCR/L 12	●	●	25	25	23	50	200	17	≥32					

R: Sağ / Right / Правый L: Sol/Left/Левый
● Stokta / In Stock / В наличии ○ Stokta Yok / Non Stock Item / Нет в наличии

Sipariş Örneği/Ordering Example/Образец заказа
1 ad./pcs./шт S0608H SCLCR 03

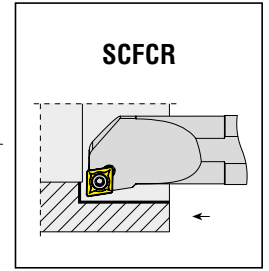
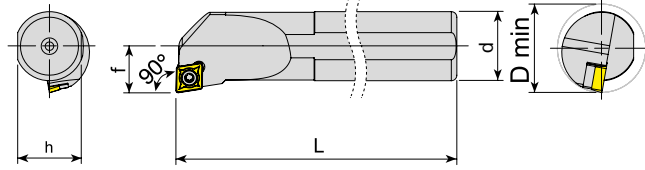

Takım Kodu Ordering Code Код для заказа	Stok Stock Наличие		Takım Ölçüleri (mm) Dimension (mm) Размеры (мм)					Kesici Uç Insert Пластина	Yedek Parçaları / Spare Parts / Запасные части			
	R	L	d	h	L	f	D min		Sıkma Vidası Screw Зажимной винт	Altlık Shim Опорная пластина	Altlık Vidası Shim Screw Винт опорной пластины	Tork Anahtar Torx Key Торх Ключ
S08H SCFCR/L 06	●	●	08	7.3	100	06	≥11	CC.T 0602..	4008-M2.5x6	-	-	80-T08
S10K SCFCR/L 06	●	●	10	09	125	07	≥13					
S12K SCFCR/L 06	●	●	12	11	125	09	≥16					
S12K SCFCR/L 09	●	●	12	11	125	09	≥16	CC.T 09T3..	4015-M3.5x8	-	-	80-T15
S16P SCFCR/L 09	●	●	16	14.8	170	11	≥20					
S20R SCFCR/L 09	●	●	20	18.3	200	13	≥25					
S25S SCFCR/L 09	●	●	25	23	250	17	≥32	CC.T 1204..	4015-M3.5x12	AACN-2-0001	AAV-08-M3.5x8	80-T20
S25S SCFCR/L 12	●	○	25	23	250	17	≥32					
S32T SCFCR/L 12	○	○	32	30	300	22	≥40	1020-M4.5x16	AACN-2-0003	AAV-10-M4.5x8	80-T20	
S40U SCFCR/L 12	○	○	40	37.5	350	27	≥50					AAV-07-M4.5x13

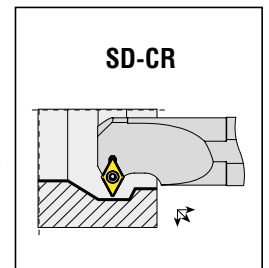
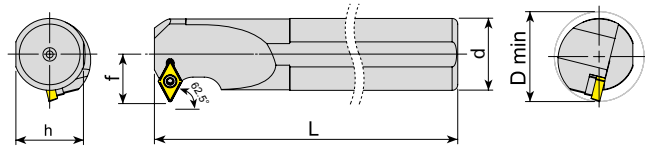

Takım Kodu Ordering Code Код для заказа	Stok Stock Наличие		Takım Ölçüleri (mm) Dimension (mm) Размеры (мм)					Kesici Uç Insert Пластина	Yedek Parçaları / Spare Parts / Запасные части			
	R	L	d	h	L	f	D min		Sıkma Vidası Screw Зажимной винт	Altlık Shim Опорная пластина	Altlık Vidası Shim Screw Винт опорной пластины	Tork Anahtar Torx Key Торх Ключ
S10K SD-CR/L 07	●	●	10	9	125	07	≥14	DC.T 0702..	4008-M2.5x6	-	-	80-T08
S12K SD-CR/L 07	●	●	12	11	125	09	≥16					
S16P SD-CR/L 07	●	●	16	14.8	170	11	≥20					
S20R SD-CR/L 07	●	○	20	18.3	200	13	≥25	DC.T 11T3..	4015-M3.5x11	-	-	80-T15
S16P SD-CR/L 11	●	●	16	14.8	170	14	≥22					
S20R SD-CR/L 11	●	●	20	18.3	200	15	≥25					
S25S SD-CR/L 11	●	●	25	23	250	18	≥32	4015-M3.5x14	AADN-2-0001	AAV-06-M3.5x11	80-T15	
S32T SD-CR/L 11	●	●	32	30	300	22	≥40					
S40U SD-CR/L 11	●	●	40	37.5	350	27	≥50					

R: Sağ / Right / Правый L: Sol/Left/Левый
● Stokta / In Stock / В наличии ○ Stokta Yok / Non Stock Item / Нет в наличии

Sipariş Örneği/Ordering Example/Образец заказа
1 ad./pcs./шт S08H SCFCR 06

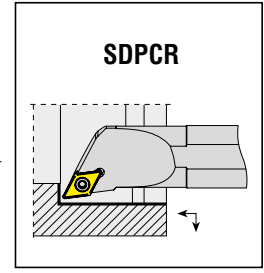
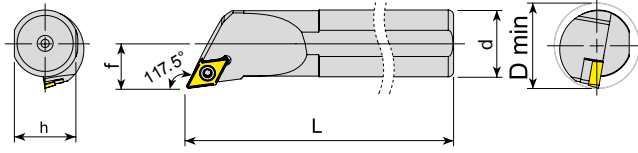

Takım Kodu Ordering Code Код для заказа	Stok Stock Наличие		Takım Ölçüleri (mm) Dimension (mm) Размеры (мм)					Kesici Uç Insert Пластина	Yedek Parçaları / Spare Parts / Запасные части			
	R	L	d	h	L	f	D min		Sıkma Vidası Screw Зажимной винт	Altılık Shim Опорная пластина	Altılık Vidası Shim Screw Винт опорной пластины	Tork Anahtar Torx Key Торх Ключ
S10K SDPCR/L 07	●	●	10	09	125	07	≥13	DC.T 0702..	4008-M2.5x6	-	-	80-T08
S12K SDPCR/L 07	●	●	12	11	125	09	≥16					
S16P SDPCR/L 11	●	●	16	14.8	170	11	≥20	DC.T 11T3..	4015-M3.5x9	-	-	80-T15
S20R SDPCR/L 11	●	●	20	18.3	200	13	≥25		4015-M3.5x11			
S25S SDPCR/L 11	●	●	25	23	250	17	≥32		4015-M3.5x12			

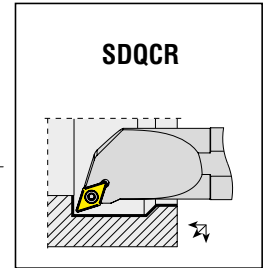
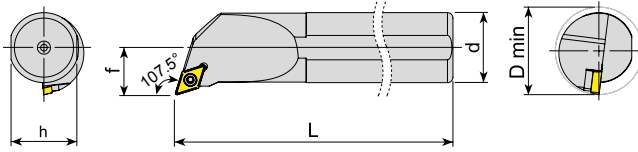

Takım Kodu Ordering Code Код для заказа	Stok Stock Наличие		Takım Ölçüleri (mm) Dimension (mm) Размеры (мм)					Kesici Uç Insert Пластина	Yedek Parçaları / Spare Parts / Запасные части				
	R	L	d	h	L	f	D min		Sıkma Vidası Screw Зажимной винт	Altılık Shim Опорная пластина	Altılık Vidası Shim Screw Винт опорной пластины	Tork Anahtar Torx Key Торх Ключ	
S10K SDQCR/L 07	●	●	10	09	125	07	≥13	DC.T 0702..	4008-M2.5x6	-	-	80-T08	
S12K SDQCR/L 07	●	●	12	11	125	09	≥16						
S16P SDQCR/L 07	●	●	16	14.8	170	11	≥20	DC.T 11T3..	4015-M3.5x9	-	-	80-T15	
S20R SDQCR/L 07	●	●	20	18.3	200	13	≥25		4015-M3.5x11				
S16P SDQCR/L 11	●	●	16	14.8	170	11	≥20		4015-M3.5x12				AADN-2-0001
S20R SDQCR/L 11	●	●	20	18.3	200	13	≥25	4015-M3.5x14	-	-	80-T15		
S25S SDQCR/L 11	●	●	25	23	250	17	≥32					AAV-06-M3.5x11	
S32T SDQCR/L 11	●	●	32	30	300	22	≥40	DC.T 0702..	4008-M2.5x6	-	-	80-T08	
S40U SDQCR/L 11	●	●	40	37.5	350	27	≥50						
A10H SDQCR/L 07	●	●	10	09	100	07	≥13	DC.T 11T3..	4015-M3.5x9	-	-	80-T15	
A12H SDQCR/L 07	●	●	12	11	100	09	≥16						4015-M3.5x11
A16M SDQCR/L 07	●	●	16	14.8	150	11	≥20						4015-M3.5x12
A20P SDQCR/L 07	●	●	20	18.3	170	13	≥25	4015-M3.5x14	-	-	80-T15		
A16M SDQCR/L 11	●	●	16	14.8	150	11	≥20					AAV-06-M3.5x11	
A20P SDQCR/L 11	●	●	20	18.3	170	13	≥25	DC.T 11T3..	4015-M3.5x9	-	-	80-T15	
A25R SDQCR/L 11	●	●	25	23	200	17	≥32						4015-M3.5x11
A32S SDQCR/L 11	●	●	32	30	250	22	≥40						4015-M3.5x12
								4015-M3.5x14					

R: Sağ / Right / Правый L: Sol/Left/Левый
● Stokta / In Stock / В наличии ○ Stokta Yok / Non Stock Item / Нет в наличии

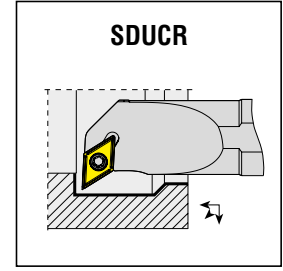
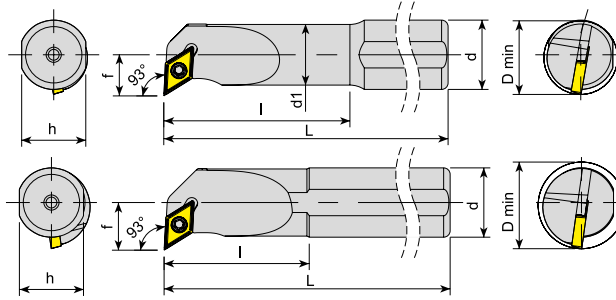

Takım Kodu Ordering Code Код для заказа	Stok Stock Наличие		Takım Ölçüleri (mm) Dimension (mm) Размеры (мм)						Kesici Uç Insert Пластина	Yedek Parçaları / Spare Parts / Запасные части				
	R	L	d	d1	h	l	L	f		D min	Sıkma Vidası Screw Зажимной винт	Altlık Shim Опорная пластина	Altlık Vidası Shim Screw Винт опорной пластины	Tork Anahtar Torx Key Торх Ключ
S0810K SDUCR/L 07	●	●	10	8	09	30	125	08	≥13	DC.T 0702..	4008-M2.5x6	-	-	80-T08
S10K SDUCR/L 07	●	●	10	10	09	25	125	08	≥13					
S12K SDUCR/L 07	●	●	12	12	11	25	125	09	≥16					
S1216P SDUCR/L 07	●	●	16	11.5	14.8	37	170	09	≥16					
S1416P SDUCR/L 07	●	●	16	14	14.8	45	170	9.5	≥17					
S16P SDUCR/L 07	●	●	16	16	14.8	35	170	11	≥20					
S20R SDUCR/L 07	●	●	20	20	18.3	40	200	13	≥25					
S1416P SDUCR/L 11	●	●	16	14	14.8	45	170	11	≥18	DC.T 11T3..	4015-M3.5x9	-	-	80-T15
S16P SDUCR/L 11	●	●	16	16	14.8	35	170	11	≥20					
S1620R SDUCR/L 11	●	●	20	16	18.3	50	200	11	≥20					
S20R SDUCR/L 11	●	●	20	20	18.3	40	200	13	≥25					
S25S SDUCR/L 11	●	●	25	25	23	50	250	17	≥32					
S32T SDUCR/L 11	●	●	32	32	30	60	300	22	≥40					
S40U SDUCR/L 11	●	●	40	40	37.5	70	350	27	≥50					
S50V SDUCR/L 11	●	●	50	50	47	80	400	35	≥63					
A0810H SDUCR/L 07	●	●	10	8	09	30	100	08	≥13	DC.T 0702..	4008-M2.5x6	-	-	80-T08
A10H SDUCR/L 07	●	●	10	10	09	25	100	08	≥13					
A12H SDUCR/L 07	●	●	12	12	11	25	100	09	≥16					
A16M SDUCR/L 07	●	●	16	16	14.8	35	150	11	≥20					
A20P SDUCR/L 07	●	●	20	20	18.3	40	170	13	≥25					
A16M SDUCR/L 11	●	●	16	16	14.8	35	150	11	≥20	DC.T 11T3..	4015-M3.5x9	-	-	80-T15
A20P SDUCR/L 11	●	●	20	20	18.3	40	170	13	≥25					
A25R SDUCR/L 11	●	●	25	25	23	50	200	17	≥32					
A32S SDUCR/L 11	●	●	32	32	30	60	250	22	≥40					

R: Sağ / Right / Правый L: Sol/Left/Левый
● Stokta / In Stock / В наличии ○ Stokta Yok / Non Stock Item / Нет в наличии

Sipariş Örneği/Ordering Example/Образец заказа
1 ad./pcs./шт S0810K SDUCR 07



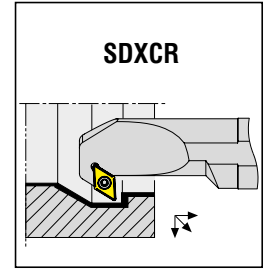
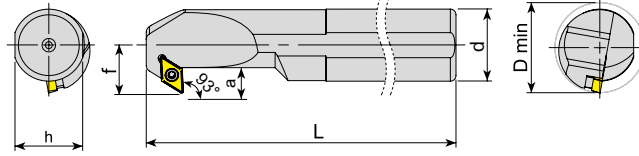

Takım Kodu Ordering Code Код для заказа	Stok Stock Наличие	Takım Ölçüleri (mm) Dimension (mm) Размеры (мм)							Kesici Uç Insert Пластина	Yedek Parçaları / Spare Parts / Запасные части				
		R	L	d	h	L	f	a		D min	Sıkma Vidası Screw Зажимной винт	Altlık Shim Опорная пластина	Altlık Vidası Shim Screw Винт опорной пластины	Tork Anahtar Torx Key Торх Ключ
S12K SDXCR/L 07	●●	12	11	125	09	4.5	≥16	DC.T 0702..						
S16P SDXCR/L 07	●●	16	14.8	170	11	6.5	≥20							
S20R SDXCR/L 07	●●	20	18.3	200	13	6.5	≥25							
S16P SDXCR/L 11	●●	16	14.8	170	11	7.5	≥20	DC.T 11T3..						
S20R SDXCR/L 11	●●	20	18.3	200	14	7.5	≥25							
S25S SDXCR/L 11	●●	25	23	250	17	9	≥32							
S32T SDXCR/L 11	●●	32	30	300	22	12.5	≥40							
S40U SDXCR/L 11	●●	40	37.5	350	27	14.5	≥50				AADN-2-0001	AAV-08-M3.5x8	AAV-06-M3.5x11	80-T15

Not: "a" ölçüleri R0.4'e göre verilmiştir.
Note: Dimensions of "a" are given according to R.04.
Примечание: размеры должны быть R.04

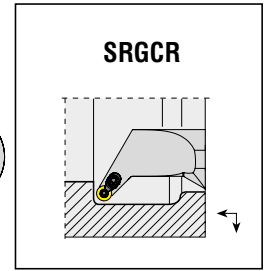
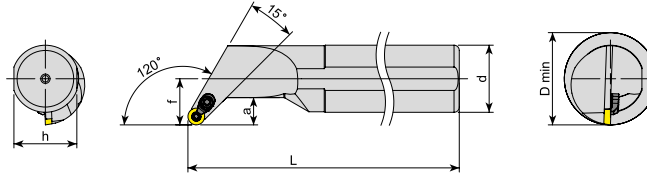

Takım Kodu Ordering Code Код для заказа	Stok Stock Наличие	Takım Ölçüleri (mm) Dimension (mm) Размеры (мм)							Kesici Uç Insert Пластина	Yedek Parçaları / Spare Parts / Запасные части					
		R	L	d	h	L	f	a		D min	Sıkma Vidası Screw Зажимной винт	Altlık Shim Опорная пластина	Altlık Vidası Shim Screw Винт опорной пластины	Baskı Pabucu Shim Screw Прижим	Pabuç Vidası Shim Screw Винт прижима
S16P SRGCR/L 08	●○	16	14.8	170	11	7	≥22	RCM. 0803..							
S20R SRGCR/L 08	●●	20	18.3	200	13	7	≥26								
S25S SRGCR/L 08C	●●	25	23	250	17	9.5	≥34								
S32T SRGCR/L 08C	●○	32	30	300	22	13	≥44								
S40U SRGCR/L 08C	●○	40	37.5	350	27	15	≥54								
												ACK-15	4015-M3.5x11	80-T08	

R: Sağ / Right / Правый L: Sol/Left/Левый
● Stokta / In Stock / В наличии ○ Stokta Yok / Non Stock Item / Нет в наличии

Sipariş Örneği/Ordering Example/Образец заказа
1 ad./pcs./шт S12K SDXCR 07

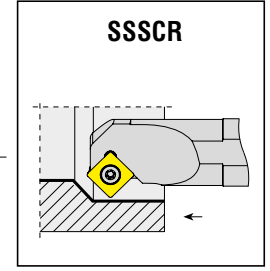
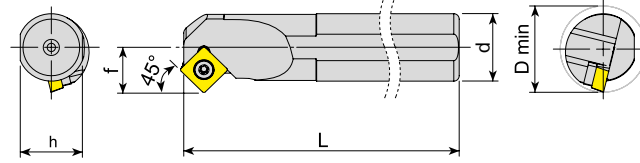

Takım Kodu Ordering Code Код для заказа	Stok Stock Наличие		Takım Ölçüleri (mm) Dimension (mm) Размеры (мм)					Kesici Uç Insert Пластина	Yedek Parçaları / Spare Parts / Запасные части			
	R	L	d	h	L	f	D min		Sıkma Vidası Screw Зажимной винт	Altlık Shim Опорная пластина	Altlık Vidası Shim Screw Винт опорной пластины	Tork Anahtar Torx Key Торх Ключ
S16P SSSCR/L 09	●	●	16	14.8	170	11	≥20	SC.T 09T3..		-		80-T15
S20R SSSCR/L 09	●	●	20	18.3	200	13	≥25					
S25S SSSCR/L 09	●	●	25	23	250	17	≥32					
S25S SSSCR/L 12	●	●	25	23	250	17	≥32	SC.T 1204..		AASN-2-0001	AAV-08-M3.5x8	80-T20
S32T SSSCR/L 12	●	○	32	30	300	22	≥40					
S40U SSSCR/L 12	●	○	40	37.5	350	27	≥50					

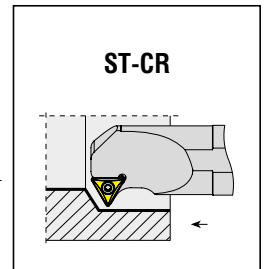
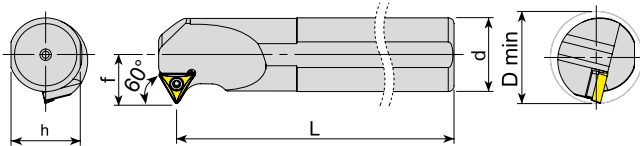

Takım Kodu Ordering Code Код для заказа	Stok Stock Наличие		Takım Ölçüleri (mm) Dimension (mm) Размеры (мм)					Kesici Uç Insert Пластина	Yedek Parçaları / Spare Parts / Запасные части			
	R	L	d	h	L	f	D min		Sıkma Vidası Screw Зажимной винт	Altlık Shim Опорная пластина	Altlık Vidası Shim Screw Винт опорной пластины	Tork Anahtar Torx Key Торх Ключ
S12K ST-CR/L 11	●	●	12	11	125	09	≥17	TC.T 1102..		-		80-T08
S16P ST-CR/L 11	●	○	16	14.8	170	11	≥20					
S20R ST-CR/L 11	●	○	20	18.3	200	13	≥25					
S16P ST-CR/L 16	●	●	16	14.8	170	11	≥20	TC.T 16T3..		AATN-2-0001	AAV-08-M3.5x8	80-T15
S20R ST-CR/L 16	●	●	20	18.3	200	13	≥25					
S25S ST-CR/L 16	●	●	25	23	250	17	≥32					
S32T ST-CR/L 16	●	●	32	30	300	22	≥40					
S40U ST-CR/L 16	●	●	40	37.5	350	27	≥50	4015-M3.5x14	AAV-06-M3.5x11			

R: Sağ / Right / Правый L: Sol/Left/Левый
● Stokta / In Stock / В наличии ○ Stokta Yok / Non Stock Item / Нет в наличии

Sipariş Örneği/Ordering Example/Образец заказа
1 ad./pcs./шт S16P SSSCR 09

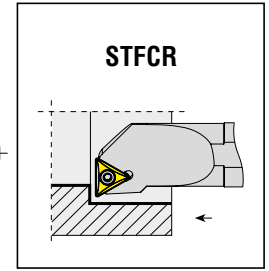
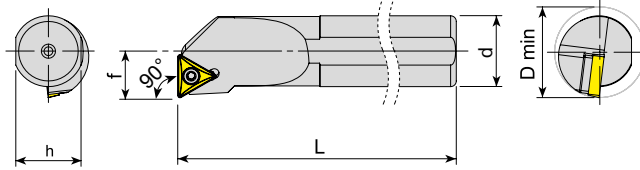

Takım Kodu Ordering Code Код для заказа	Stok Stock Наличие		Takım Ölçüleri (mm) Dimension (mm) Размеры (мм)					Kesici Uç Insert Пластина	Yedek Parçaları / Spare Parts / Запасные части			
	R	L	d	h	L	f	D min		Sıkma Vidası Screw Зажимной винт	Altılık Shim Опорная пластина	Altılık Vidası Shim Screw Винт опорной пластины	Tork Anahtar Torx Key Торх Ключ
S0610F STFCR/L 06	●	●	10	09	80	4.5	≥08	TC.T 06T1..	3006-M2x4			80-T06
S08H STFCR/L 06	●	●	08	7.3	100	06	≥11					
S10K STFCR/L 09	●	●	10	09	125	07	≥13	TC.T 0902..	3007-M2.2x5	-	-	80-T07
S12K STFCR/L 09	●	●	12	11	125	09	≥17					
S12K STFCR/L 11	●	●	12	11	125	09	≥17	TC.T 1102..	4008-M2.5x6			80-T08
S16P STFCR/L 11	●	●	16	14.8	170	11	≥20					
S20R STFCR/L 11	●	●	20	18.3	200	13	≥25	TC.T 16T3..	4015-M3.5x9 4015-M3.5x11	-	-	80-T15
S16P STFCR/L 16	●	●	16	14.8	170	11	≥20					
S20R STFCR/L 16	●	●	20	18.3	200	13	≥25					
S25S STFCR/L 16	●	●	25	23	250	17	≥32					
S32T STFCR/L 16	●	●	32	30	300	22	≥40					
S40U STFCR/L 16	●	○	40	37.5	350	27	≥50	4015-M3.5x14	AATN-2-0001	AAV-06-M3.5x11		

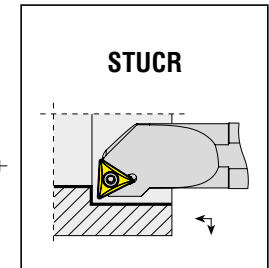
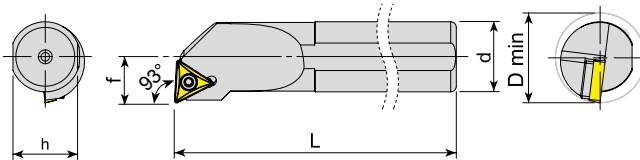





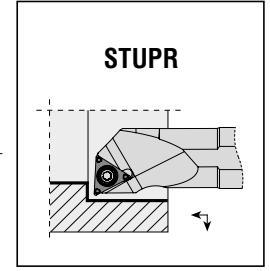
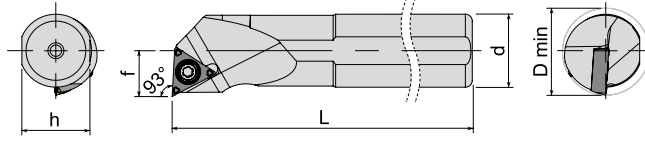

Takım Kodu Ordering Code Код для заказа	Stok Stock Наличие		Takım Ölçüleri (mm) Dimension (mm) Размеры (мм)					Kesici Uç Insert Пластина	Yedek Parçaları / Spare Parts / Запасные части			
	R	L	d	h	L	f	D min		Sıkma Vidası Screw Зажимной винт	Altılık Shim Опорная пластина	Altılık Vidası Shim Screw Винт опорной пластины	Tork Anahtar Torx Key Торх Ключ
S10K STUCR/L 09	●	●	10	09	125	07	≥13	TC.T 0902..	3007-M2.2x5			80-T07
S12K STUCR/L 09	●	●	12	11	125	09	≥16					
S12K STUCR/L 11	●	●	12	11	125	09	≥17	TC.T 1102..	4008-M2.5x6	-	-	80-T08
S16P STUCR/L 11	●	●	16	14.8	170	11	≥20					
S20R STUCR/L 11	●	●	20	18.3	200	13	≥25	TC.T 16T3..	4015-M3.5x9 4015-M3.5x11	-	-	80-T15
S16P STUCR/L 16	●	●	16	14.8	170	11	≥20					
S20R STUCR/L 16	●	●	20	18.3	200	13	≥25					
S25S STUCR/L 16	●	●	25	23	250	17	≥32					
S32T STUCR/L 16	●	●	32	30	300	22	≥40					
S40U STUCR/L 16	●	●	40	37.5	350	27	≥50	4015-M3.5x14	AATN-2-0001	AAV-06-M3.5x11		





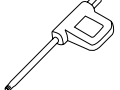
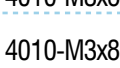
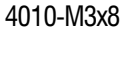

R: Sağ / Right / Правый L: Sol/Left/Левый
● Stokta / In Stock / В наличии ○ Stokta Yok / Non Stock Item / Нет в наличии

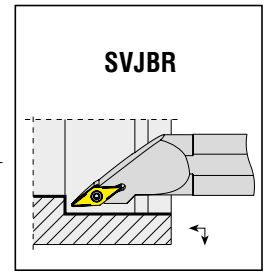
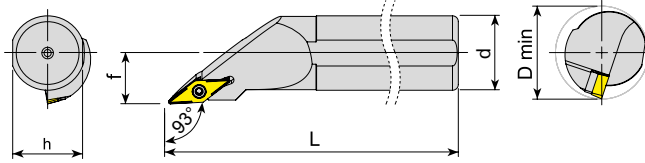
Sipariş Örneği/Ordering Example/Образец заказа
1 ad./pcs./шт S0610F STFCR 06



Takım Kodu Ordering Code Код для заказа	Stok Stock Наличие		Takım Ölçüleri (mm) Dimension (mm) Размеры (мм)					Kesici Uç Insert Пластина	Yedek Parçaları / Spare Parts / Запасные части			
	R	L	d	h	L	f	D min		Sıkma Vidası Screw Зажимной винт	Altlık Shim Опорная пластина	Altlık Vidası Shim Screw Винт опорной пластины	Tork Anahtar Torx Key Торх Ключ
S08H STUPR/L 0802	●	○	08	7.3	100	05	≥10	 TP.. 0802..	 3006-M2x4			 80-T06
S10K STUPR/L 1103	●	○	10	09	125	06	≥12					
S12K STUPR/L 1103	●	●	12	11	125	09	≥16					
S12M STUPR/L 1103	●	●	12	11	150	08	≥16					
S16P STUPR/L 1103	●	●	16	14.8	170	10	≥20					
S16R STUPR/L 1103	●	●	16	14.8	200	10	≥20					
								 4010-M3x6  4010-M3x8	-	-	 80-T10	



Takım Kodu Ordering Code Код для заказа	Stok Stock Наличие		Takım Ölçüleri (mm) Dimension (mm) Размеры (мм)					Kesici Uç Insert Пластина	Yedek Parçaları / Spare Parts / Запасные части			
	R	L	d	h	L	f	D min		Sıkma Vidası Screw Зажимной винт	Altlık Shim Опорная пластина	Altlık Vidası Shim Screw Винт опорной пластины	Tork Anahtar Torx Key Торх Ключ
S25S SVJBR/L 16	●	●	25	23	250	17	≥32	 VBM. 1604..	 4015-M3.5x12  4015-M3.5x14		 AAV-08-M3.5x8  AAV-06-M3.5x11	 80-T15
S32T SVJBR/L 16	●	●	32	30	300	22	≥40					
S40U SVJBR/L 16	●	●	40	37.5	350	27	≥50					

R: Sağ / Right / Правый L: Sol/Left/Левый
● Stokta / In Stock / В наличии ○ Stokta Yok / Non Stock Item / Нет в наличии

Sipariş Örneği/Ordering Example/Образец заказа
1 ad./pcs./шт S08H STUPR 0802

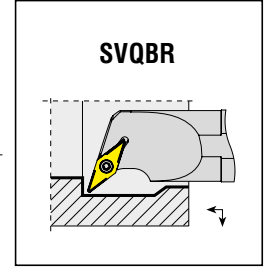
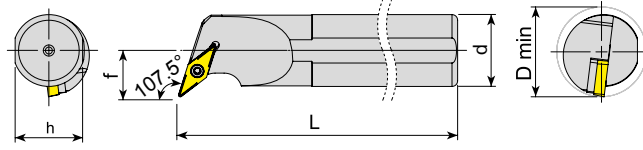

Takım Kodu Ordering Code Код для заказа	Stok Stock Наличие		Takım Ölçüleri (mm) Dimension (mm) Размеры (мм)					Kesici Uç Insert Пластина	Yedek Parçaları / Spare Parts / Запасные части			
	R	L	d	h	L	f	D min		Sıkma Vidası Screw Зажимной винт	Altılık Shim Опорная пластина	Altılık Vidası Shim Screw Винт опорной пластины	Tork Anahtar Torx Key Торх Ключ
S16P SVQBR/L 11	●	●	16	14.8	170	11	≥20	VBM. 1103..	4008-M2.5x6	-	-	80-T08
S20R SVQBR/L 11	●	●	20	18.3	200	13	≥25					
S25S SVQBR/L 16	●	●	25	23	250	17	≥32	VBM. 1604..	4015-M3.5x14	AAVN-2-0002	AAV-08-M3.5x8	80-T15
S32T SVQBR/L 16	●	●	32	30	300	22	≥40				AAV-06-M3.5x11	
S40U SVQBR/L 16	●	●	40	37.5	350	27	≥50	VBM. 1103..	4008-M2.5x6	-	-	80-T08
A20Q SVQBR/L 11	●	●	20	18.5	180	13	≥25					
A20Q SVQBR/L 16	●	●	20	18.5	180	20	≥30	VBM. 1604..	4015-M3.5x11	-	-	80-T15
A25S SVQBR/L 16	●	●	25	23	250	17	≥32					
A32S SVQBR/L 16	●	●	32	30	250	22	≥40	4015-M3.5x14	AAVN-2-0002	AAV-06-M3.5x11	80-T15	

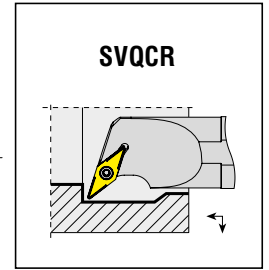
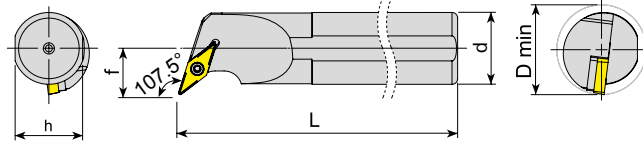

Takım Kodu Ordering Code Код для заказа	Stok Stock Наличие		Takım Ölçüleri (mm) Dimension (mm) Размеры (мм)					Kesici Uç Insert Пластина	Yedek Parçaları / Spare Parts / Запасные части			
	R	L	d	h	L	f	D min		Sıkma Vidası Screw Зажимной винт	Altılık Shim Опорная пластина	Altılık Vidası Shim Screw Винт опорной пластины	Tork Anahtar Torx Key Торх Ключ
S16P SVQCR/L 11	●	●	16	14.8	170	11	≥20	VC.T 1103..	4008-M2.5x6	-	-	80-T08
S20R SVQCR/L 11	●	●	20	18.3	200	13	≥25					
S25S SVQCR/L 16	●	●	25	23	250	17	≥32	VC.T 1604..	4015-M3.5x14	AAVN-2-0002	AAV-08-M3.5x8	80-T15
S32T SVQCR/L 16	●	●	32	30	300	22	≥40				AAV-06-M3.5x11	
S40U SVQCR/L 16	●	●	40	37.5	350	27	≥50					

R: Sağ / Right / Правый L: Sol/Left/Левый
● Stokta / In Stock / В наличии ○ Stokta Yok / Non Stock Item / Нет в наличии

Sipariş Örneği/Ordering Example/Образец заказа
1 ad./pcs./шт S16P SVQBR 11

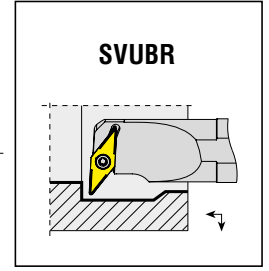
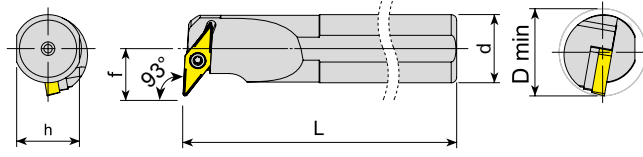

Takım Kodu Ordering Code Код для заказа	Stok Stock Наличие		Takım Ölçüleri (mm) Dimension (mm) Размеры (мм)					Kesici Uç Insert Пластина	Yedek Parçaları / Spare Parts / Запасные части			
	R	L	d	h	L	f	D min		Sıkma Vidası Screw Зажимной винт	Altık Shim Опорная пластина	Altık Vidası Shim Screw Винт опорной пластины	Tork Anahtar Torx Key Торх Ключ
S16P SVUBR/L 11	●	●	16	14.8	170	12.5	≥20	VBM. 1103..	4008-M2.5x6	-	-	80-T08
S20R SVUBR/L 11	●	●	20	18.3	200	13	≥25					
S25S SVUBR/L 16	●	●	25	23	250	19	≥32	VBM. 1604..	4015-M3.5x14	AAVN-2-0002	AAV-06-M3.5x11	80-T15
S32T SVUBR/L 16	●	●	32	30	300	22	≥40					
S40U SVUBR/L 16	●	●	40	37.5	350	27	≥50					
A20Q SVUBR/L 16	●	○	20	18.3	180	20	≥30					
A32S SVUBR/L 16	●	●	32	30	250	22	≥40	4015-M3.5x14	AAVN-2-0002	AAV-06-M3.5x11		

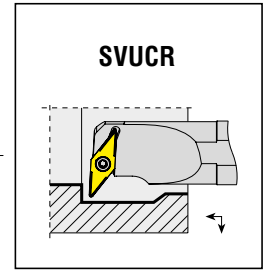
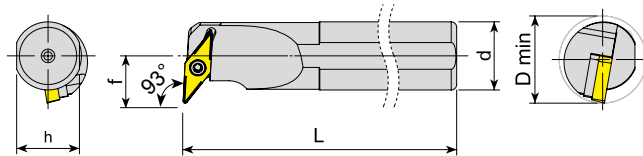

Takım Kodu Ordering Code Код для заказа	Stok Stock Наличие		Takım Ölçüleri (mm) Dimension (mm) Размеры (мм)					Kesici Uç Insert Пластина	Yedek Parçaları / Spare Parts / Запасные части			
	R	L	d	h	L	f	D min		Sıkma Vidası Screw Зажимной винт	Altık Shim Опорная пластина	Altık Vidası Shim Screw Винт опорной пластины	Tork Anahtar Torx Key Торх Ключ
S16P SVUCR/L 11	●	●	16	14.8	170	12.5	≥20	VC.T 1103..	4008-M2.5x6	-	-	80-T08
S20R SVUCR/L 11	●	●	20	18.3	200	13	≥25					
S25S SVUCR/L 16	●	●	25	23	250	19	≥32	VC.T 1604..	4015-M3.5x14	AAVN-2-0002	AAV-06-M3.5x11	80-T15
S32T SVUCR/L 16	●	●	32	30	300	22	≥40					
S40U SVUCR/L 16	●	●	40	37.5	350	27	≥50					
A12K SVUCR/L 07	●	●	12	11	125	9	≥16					
A20Q SVUCR/L 11	●	○	20	18.3	180	13	≥25	VC.T 1103..	4008-M2.5x6	-	-	80-T08
A25R SVUCR/L 16	●	●	25	23	200	19	≥32	VC.T 1604..	4015-M3.5x14	AAVN-2-0002	AAV-06-M3.5x11	80-T15

R: Sağ / Right / Правый L: Sol/Left/ Левый
● Stokta / In Stock / В наличии ○ Stokta Yok / Non Stock Item / Нет в наличии

Sipariş Örneği/Ordering Example/Образец заказа
1 ad./pcs./шт S16P SVUBR 11

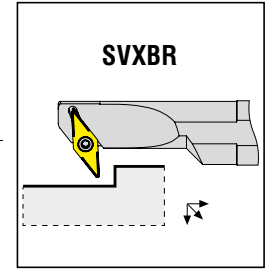
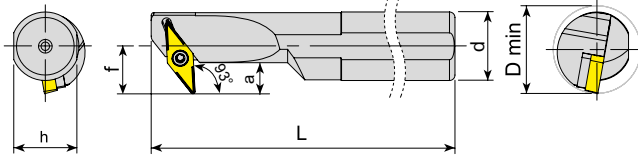

Takım Kodu Ordering Code Код для заказа	Stok Stock Наличие		Takım Ölçüleri (mm) Dimension (mm) Размеры (мм)					Kesici Uç Insert Пластина	Yedek Parçaları / Spare Parts / Запасные части				
	R	L	d	h	L	f	a		D min	Sıkma Vidası Screw Зажимной винт	Altlık Shim Опорная пластина	Altlık Vidası Shim Screw Винт опорной пластины	Tork Anahtar Torx Key Торх Ключ
S16P SVXBR/L 1102	●	○	16	14.8	170	12.5	7.2	≥20	VBM. 1102..	4008-M2.5x6	-	-	80-T08
S20R SVXBR/L 1102	●	●	20	18.3	200	13	5.7	≥25					
S16P SVXBR/L 11	●	●	16	14.8	170	12.5	7.2	≥20	VBM. 1103..	-	-	80-T08	
S20R SVXBR/L 11	●	●	20	18.3	200	13	5.7	≥25					
S25S SVXBR/L 16	●	●	25	23	250	19	10.2	≥32	VBM. 1604..	4015-M3.5x14	AAVN-2-0002	AAV-06-M3.5x11	80-T15
S32T SVXBR/L 16	●	●	32	30	300	22	11.7	≥40					
S40U SVXBR/L 16	●	●	40	37.5	350	27	14.3	≥50					

Not: "a" ölçüleri R0.4'e göre verilmiştir.
Note: Dimensions of "a" are given according to R.04.
Примечание: размеры должны быть R.04

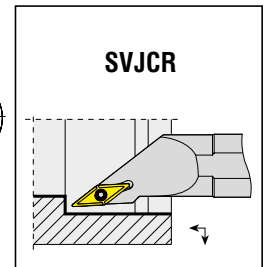
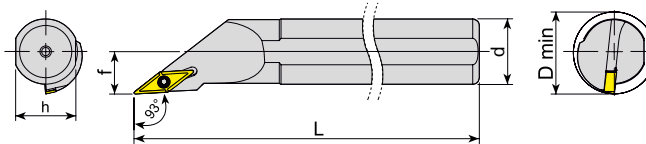

Takım Kodu Ordering Code Код для заказа	Stok Stock Наличие		Takım Ölçüleri (mm) Dimension (mm) Размеры (мм)					Kesici Uç Insert Пластина	Yedek Parçaları / Spare Parts / Запасные части			
	R	L	d	h	L	f	D min		Sıkma Vidası Screw Зажимной винт	Altlık Shim Опорная пластина	Altlık Vidası Shim Screw Винт опорной пластины	Tork Anahtar Torx Key Торх Ключ
S12K SVJCR/L 11	●	●	12	11	125	7	13	VC.T 1103..	4008-M2.5x6	-	-	80-T08
S16P SVJCR/L 11	●	●	16	14.8	170	11	20					
S20R SVJCR/L 11	●	●	20	18.3	200	13	25					

R: Sağ / Right / Правый L: Sol/Left/Левый
● Stokta / In Stock / В наличии ○ Stokta Yok / Non Stock Item / Нет в наличии

Sipariş Örneği/Ordering Example/Образец заказа
1 ad./pcs./шт S16P SVXBR 1102

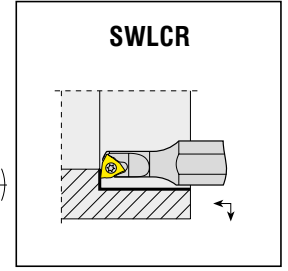
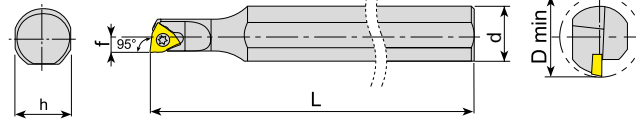

Takım Kodu Ordering Code Код для заказа	Stok Stock Наличие	Takım Ölçüleri (mm) Dimension (mm) Размеры (мм)					Kesici Uç Insert Пластина	Yedek Parçaları / Spare Parts / Запасные части			
		d	h	L	f	D min		Sıkma Vidası Screw Зажимной винт	Altık Shim Opornaya platinası	Altık Vidası Shim Screw Винт опорной пластины	Tork Anahtar Torx Key Торх Ключ
S0608H SWLCR 03	●	08	7.3	100	04	≥08	WC.. 0302..	4008-M2.5x4	-	-	80-T08
S0810K SWLCR 03	●	10	09	125	06	≥10					

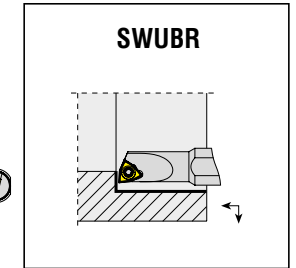
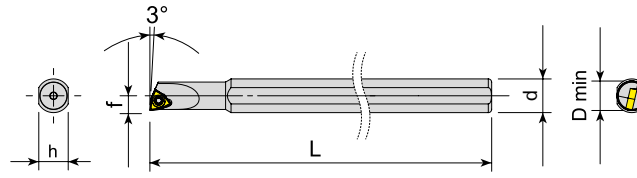

Takım Kodu Ordering Code Код для заказа	Stok Stock Наличие	Takım Ölçüleri (mm) Dimension (mm) Размеры (мм)					Kesici Uç Insert Пластина	Yedek Parçaları / Spare Parts / Запасные части			
		d	h	L	f	D min		Sıkma Vidası Screw Зажимной винт	Altık Shim Opornaya platinası	Altık Vidası Shim Screw Винт опорной пластины	Tork Anahtar Torx Key Торх Ключ
S08H SWUBR 06-5.5	●	08	7.3	100	2.75	≥5.5	WBG 060102-L	3006-M2x3.6	-	-	80-T06
S08H SWUBR 06-7	●	08	7.3	100	3.5	≥7		3006-M2x4			

R: Sağ / Right / Правый L: Sol/Left/ Левый

● Stokta / In Stock / В наличии ○ Stokta Yok / Non Stock Item / Нет в наличии

KYCR-ISCR Ucuna Uygundur. / Compatible with KYCR-ISCR Insert. / Под пластину KYCR-ISCR

Sipariş Örneği/Ordering Example/Образец заказа

1 ad./pcs./шт S0608H SWLCR 03

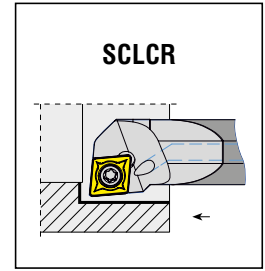
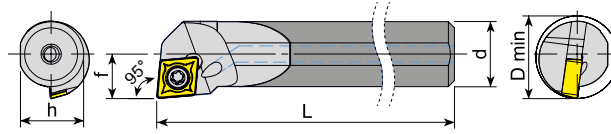

Takım Kodu Ordering Code Код для заказа	Stok Stock Наличие		Takım Ölçüleri (mm) Dimension (mm) Размеры (мм)					Kesici Uç Insert Пластина	Yedek Parçaları / Spare Parts / Запасные части						
	R	L	d	h	L	f	D min		Sıkma Vidası Screw Зажимной винт	Altık Shim Опорная пластина	Altık Vidası Shim Screw Винт опорной пластины	Anahtar Allen Key Ключ			
E08K SCLCR/L 06	●	●	8	7.5	125	6	≥11								
E10M SCLCR/L 06	●	●	10	9.5	150	7	≥13						CC.T 0602..	4008-M2.5x6	80-T08
E12Q SCLCR/L 06	●	●	12	11	180	9	≥16							-	-
E16R SCLCR/L 09	●	●	16	15	200	11	≥20	CC.T 09T3..	4015-M3.5x9			80-T15			
E20S SCLCR/L 09	●	●	20	19	250	13	≥24								

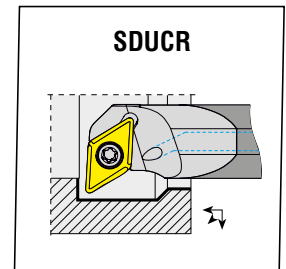
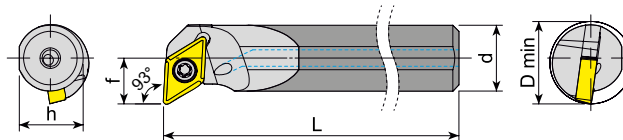

Takım Kodu Ordering Code Код для заказа	Stok Stock Наличие		Takım Ölçüleri (mm) Dimension (mm) Размеры (мм)					Kesici Uç Insert Пластина	Yedek Parçaları / Spare Parts / Запасные части								
	R	L	d	h	L	f	D min		Sıkma Vidası Screw Зажимной винт	Altık Shim Опорная пластина	Altık Vidası Shim Screw Винт опорной пластины	Anahtar Allen Key Ключ					
E10M SDUCR/L 07	●	●	10	9.5	150	8	≥13										
E12Q SDUCR/L 07	●	●	12	11	180	9	≥16						DC.T 0702..	4008-M2.5x6	-	-	80-T08
E16R SDUCR/L 11	●	●	16	15	200	11	≥20						DC.T 11T3..	4015-M3.5x9			80-T15
E20S SDUCR/L 11	●	●	20	18.3	250	12	≥23										

R: Sağ / Right / Правый L: Sol/Left/Левый
● Stokta / In Stock / В наличии ○ Stokta Yok / Non Stock Item / Нет в наличии

Sipariş Örneği/Ordering Example/Образец заказа
1 ad./pcs./шт E08K SCLCR 06

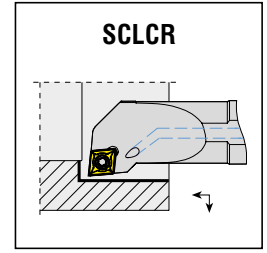
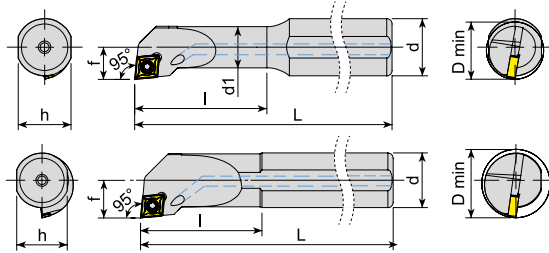

Takım Kodu Ordering Code Код для заказа	Stok Stock Наличие		Takım Ölçüleri (mm) Dimension (mm) Размеры (мм)						Kesici Uç Insert Пластина	Yedek Parçaları / Spare Parts / Запасные части				
	R	L	d	d1	h	l	L	f		D min	Sıkma Vidası Screw Зажимной винт	Altlık Shim Опорная пластина	Altlık Vidası Shim Screw Винт опорной пластины	Tork Anahtar Torx Key Торх Ключ
A08H SCLCR/L 06	●	●	8	8	7.3	20	100	6	≥11	CC.T 0602..	4008-M2.5x6	-	-	80-T08
A10H SCLCR/L 06	●	●	10	10	9	25	100	7	≥13					
A12H SCLCR/L 06	●	●	12	12	11	25	100	9	≥16					
A16M SCLCR/L 09	●	●	16	16	14.8	35	150	11	≥20					

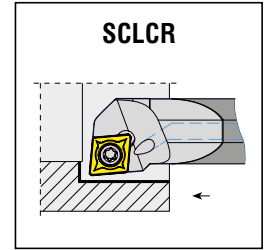
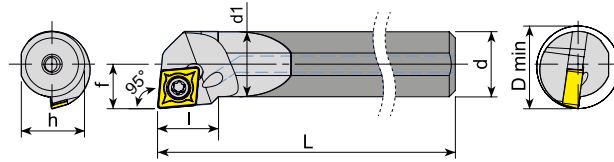

Takım Kodu Ordering Code Код для заказа	Stok Stock Наличие		Takım Ölçüleri (mm) Dimension (mm) Размеры (мм)						Kesici Uç Insert Пластина	Yedek Parçaları / Spare Parts / Запасные части				
	R	L	d	d1	h	l	L	f		D min	Sıkma Vidası Screw Зажимной винт	Altlık Shim Опорная пластина	Altlık Vidası Shim Screw Винт опорной пластины	Tork Anahtar Torx Key Торх Ключ
E08K SCLCR/L 06	●	○	8	8	7.5	10	125	6	≥11	CC.T 0602..	4008-M2.5x6	-	-	80-T08
E10M SCLCR/L 06	●	○	10	10	9.5	10	150	7	≥13					
E12Q SCLCR/L 06	●	○	12	12	11	12	180	9	≥16					
E16R SCLCR/L 09	●	○	16	16	15	15	200	11	≥20					

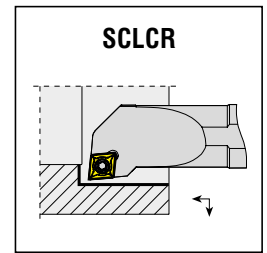
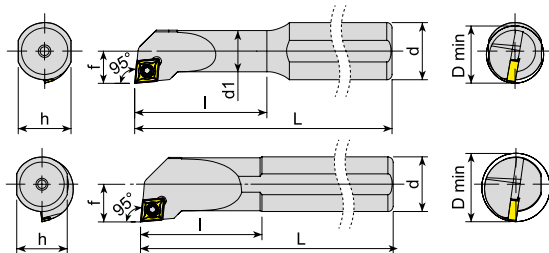

Takım Kodu Ordering Code Код для заказа	Stok Stock Наличие		Takım Ölçüleri (mm) Dimension (mm) Размеры (мм)						Kesici Uç Insert Пластина	Yedek Parçaları / Spare Parts / Запасные части				
	R	L	d	d1	h	l	L	f		D min	Sıkma Vidası Screw Зажимной винт	Altlık Shim Опорная пластина	Altlık Vidası Shim Screw Винт опорной пластины	Tork Anahtar Torx Key Торх Ключ
S08H SCLCR/L 06	●	●	8	8	7.3	20	100	6	≥11	CC.T 0602..	4008-M2.5x6	-	-	80-T08
S10K SCLCR/L 06	●	●	10	10	9	25	125	7	≥13					
S12K SCLCR/L 06	●	●	12	12	11	25	125	9	≥16					
S16P SCLCR/L 09	●	●	16	16	14.8	35	170	11	≥20					

R: Sağ / Right / Правый L: Sol/Left/Левый

● Stokta / In Stock / В наличии ○ Stokta Yok / Non Stock Item / Нет в наличии

Sipariş Örneği/Ordering Example/Образец заказа

1 ad./pcs./шт SET-A/SCLCR

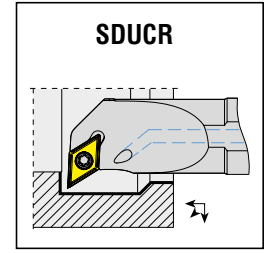
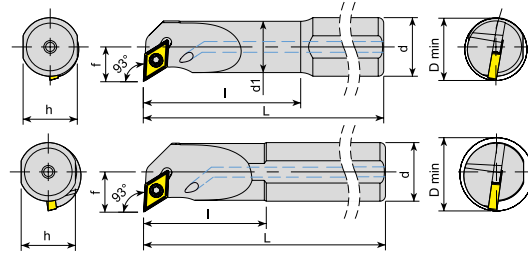

Takım Kodu Ordering Code Код для заказа	Stok / Stock / Наличие									Kesici Uç Insert Пластина	Yedek Parçaları / Spare Parts / Запасные части								
	R	L	d	d1	h	l	L	f	D min		Sıkma Vidası Screw Зажимной винт	Altlık Shim Опорная пластина	Altlık Vidası Shim Screw Винт опорной пластины	Tork Anahtar Torx Key Торх Ключ					
A10H SDUCR/L 07	●	●	10	10	09	25	100	08	≥13										
A12H SDUCR/L 07	●	●	12	12	11	25	100	09	≥16						DC.T 0702..	4008-M2.5x6	-	-	80-T08
A16M SDUCR/L 11	●	●	16	16	14.8	35	150	11	≥20						DC.T 11T3..	4015-M3.5x9	-	-	80-T15

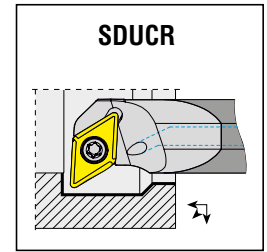
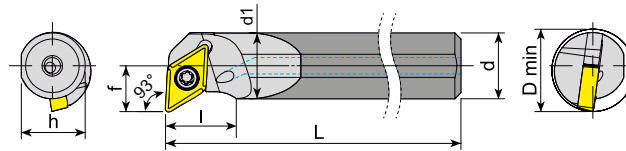

Takım Kodu Ordering Code Код для заказа	Stok / Stock / Наличие									Kesici Uç Insert Пластина	Yedek Parçaları / Spare Parts / Запасные части								
	R	L	d	d1	h	l	L	f	D min		Sıkma Vidası Screw Зажимной винт	Altlık Shim Опорная пластина	Altlık Vidası Shim Screw Винт опорной пластины	Tork Anahtar Torx Key Торх Ключ					
E10M SDUCR/L 07	●	○	10	10	9.5	09	150	8	≥13										
E12Q SDUCR/L 07	●	○	12	12	11	10	180	9	≥16						DC.T 0702..	4008-M2.5x6	-	-	80-T08
E16R SDUCR/L 11	●	○	16	16	15	12	200	11	≥20						DC.T 11T3..	4015-M3.5x9	-	-	80-T15

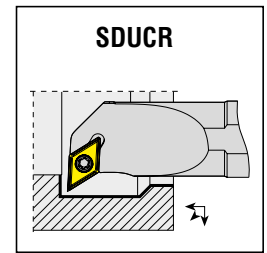
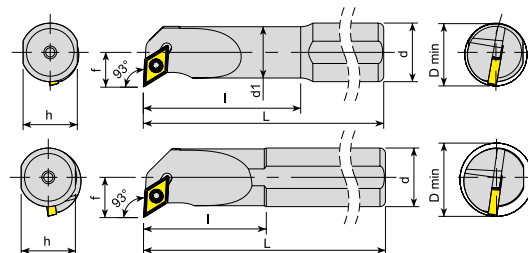

Takım Kodu Ordering Code Код для заказа	Stok / Stock / Наличие									Kesici Uç Insert Пластина	Yedek Parçaları / Spare Parts / Запасные части								
	R	L	d	d1	h	l	L	f	D min		Sıkma Vidası Screw Зажимной винт	Altlık Shim Опорная пластина	Altlık Vidası Shim Screw Винт опорной пластины	Tork Anahtar Torx Key Торх Ключ					
S10K SDUCR/L 07	●	●	10	10	9	25	125	8	≥13										
S12K SDUCR/L 07	●	●	12	12	11	25	125	9	≥16						DC.T 0702..	4008-M2.5x6	-	-	80-T08
S16P SDUCR/L 11	●	●	16	16	14.8	35	170	11	≥20						DC.T 11T3..	4015-M3.5x9	-	-	80-T15

R: Sağ / Right / Правый L: Sol/Left/Левый
● Stokta / In Stock / В наличии ○ Stokta Yok / Non Stock Item / Нет в наличии

Sipariş Örneği/Ordering Example/Образец заказа
1 ad./pcs./шт SET-A/SDUCR



*konusulan
the spoken kalite...
quality...*

KARTUŞLAR

KARTUŞLAR
CARTRIDGE
КАРТРИДЖИ





S

1

T

2

F

3

C

4

R

5

12

6

C

7

A

8

16

9

1 Sıkma Tipi / Method of Mounting of Insert / Способ монтажа вставки



Deliksiz Üstten Sıkma
Top Clamping Without Hole
Прижим сверху без отверстия

C

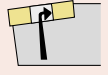

Delikten Levye ile Sıkma
Hole Clamping (Lever Lock)
Прижим рычагом за отверстие

P



Vida ile Sıkma
Screw on
Крепление винтом

S

2 Uç Tipi / Type of Insert / Форма пластины



C



S



T

3 Yanaşma Açısı / Tool Holder Shape Bar Geometry / Угол направления

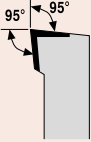

L



S

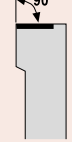

F

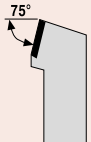

R



K



G



W



T

4 Serbest Uç Açısı / Insert Clearance Angle / Задний угол пластины



C



P



N

5 Kesme Yönü / Cutting Direction / Направление резания

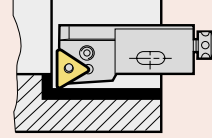

R

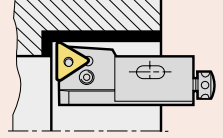

L

6 Kesme Kenar Yüksekliği / Cutting Edge Height / Высота режущей кромки

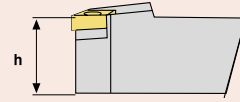

7 Kartuş Kodu / Cartridge Code / Код картриджа

C
(Kartuş / Cartridge Code / Картридж)

8 Kartuş Tipi / Cartridge Type / Тип картриджа

A
(ISO 5611)

9 Kesme Kenar Uzunluğu / Cutting Edge Length / Длина режущей кромки

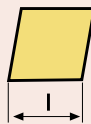

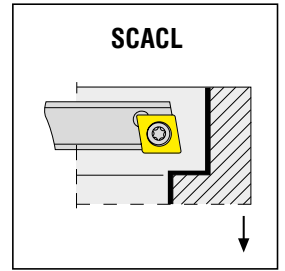
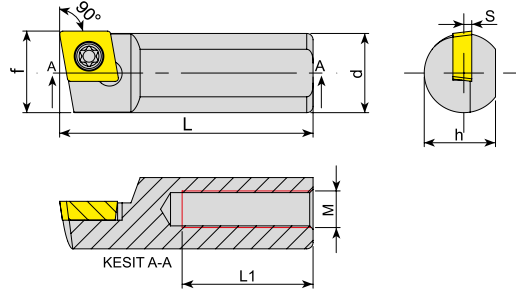

Takım Kodu Ordering Code Код для заказа	Stok Stock Наличие		Takım Ölçüleri (mm) Dimension (mm) Размеры (мм)							Kesici Uç Insert Пластина	Yedek Parçaları / Spare Parts / Запасные части		
	R	L	d	h	L	L1	S	f	M		Sıkma Vidası Screw Зажимной винт	Tork Anahtar Torx Key Торх Ключ	
S10X SCACR/L 06	●	●	10	9	25	10	1	10.3	M5x0.8	CC.. 0602..	4008-M2.5x6	80-T08	
S10A SCACR/L 06	●	●	10	9	32	15	1	10.3	M5x0.8				
S1018 SCACR/L 06	○	●	10	9	18	8	1	9.8	M5x0.8				
S1065 SCACR/L 06	○	●	10	9	65	5	1	10.3	M5x0.8				
S10C SCACR/L 06	●	●	10	9	50	25	1	10.3	M5x0.8				
S12B SCACR/L 06	●	●	12	11	40	25	1	12.3	M5x0.8				
S12D SCACR/L 06	●	●	12	11	60	25	1	12.3	M5x0.8				
S12D SCACR/L 09	●	●	12	11	60	25	2	12.2	M5x0.8				
S1265 SCACR/L 09	○	●	12	11	65	25	2	12.3	M5x0.8				
S12H SCACR/L 09	●	●	12	11	100	25	2	12.2	M5x0.8				
S15C SCACR/L 09	●	●	15	14	50	25	2	15.3	M8x1.25	CC.. 09T3..	4015-M3.5x8	80-T15	
S1554 SCACR/L 09	○	●	15	14	54	25	2	15.3	M8x1.25				
S15E SCACR/L 09	○	●	15	14	70	45	2	15.3	M8x1.25				
S15D SCACR/L 09	○	●	15	14	60	30	2	15.3	M8x1.25				
S16A SCACR/L 09	●	●	16	15	32	15	2	16.5	M6x1				
S16B SCACR/L 09	●	●	16	15	40	20	2	16.5	M6x1				
S16C SCACR/L 09	○	●	16	15	50	25	2	16.5	M6x1				
S16D SCACR/L 09	●	●	16	15	60	30	2	16.5	M6x1				
S16E SCACR/L 09	○	●	16	15	70	30	2	16.5	M6x1				
S16G SCACR/L 09	●	●	16	15	90	30	2	16.5	M6x1				
S16H SCACR/L 09	○	●	16	15	100	35	4	16.5	M6x1				
S1868 SCACR/L 09	○	●	18	17	68	30	2	18.5	M8x1.25	CC.. 1204..	1020-M5x11	80-T20	
S18E SCACR/L 09	●	●	18	17	70	30	2	18.5	M8x1.25				
S1888 SCACR/L 09	○	●	18	17	88	30	2	18.5	M8x1.25				
S18105 SCACR/L 09	○	●	18	17	105	30	2	18.5	M8x1.25				
S18175 SCACR/L 09	○	●	18	17	175	30	2	18.5	M8x1.25				
S20E SCACR/L 09	●	●	20	18.3	70	30	2	20.5	M6x1				
S20E SCACR/L 12	●	●	20	18.3	70	30	2	20.5	M6x1				
S20H SCACR/L 12	●	●	20	18.3	100	30	2	20.5	M6x1				

R: Sağ / Right / Правый L: Sol/Left/Левый

● Stokta / In Stock / В наличии ○ Stokta Yok / Non Stock Item / Нет в наличии

Sipariş Örneği/Ordering Example/Образец заказа

1 ad./pcs./шт S10X SCACR 06

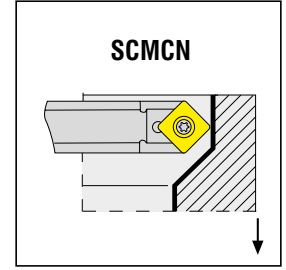
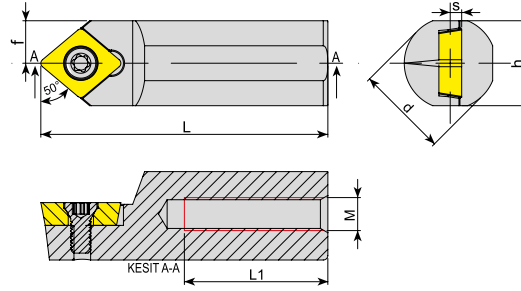

Takım Kodu Ordering Code Код для заказа	Stok Stock Наличие	Takım Ölçüleri (mm) Dimension (mm) Размеры (мм)						Kesici Uç Insert Пластина	Yedek Parçaları / Spare Parts / Запасные части		
		d	h	L	L1	S	f		M	Sıkma Vidası Screw Зажимной винт	Tork Anahtar Torx Key Торх Ключ
S10X SCMCN 06	●	10	9	25	10	1	5	M5x0.8		4008-M2.5x6	80-T08
S16C SCMCN 09	●	16	15	50	25	2	8	M6x1		4015-M3.5x11	80-T15
S16D SCMCN 09	●	16	15	60	25	4	8	M6x1		4015-M3.5x11	80-T15

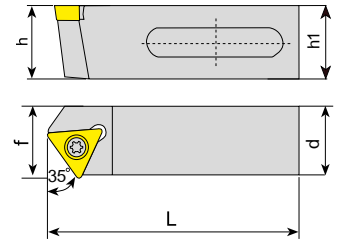

Takım Kodu Ordering Code Код для заказа	Stok Stock Наличие		Takım Ölçüleri (mm) Dimension (mm) Размеры (мм)					Kesici Uç Insert Пластина	Yedek Parçaları / Spare Parts / Запасные части		
	R	L	d	h	h1	L	f		Sıkma Vidası Screw Зажимной винт	Tork Anahtar Torx Key Торх Ключ	
STXCR/L 2020 B16	○	●	20	20	20	45	20				
STXCR/L 2020 E16	○	●	20	20	20	70	20				
STXCR/L 2020 B16-SA	○	●	20	10	20	45	20				
STXCR/L 2020 E16-SA	○	●	20	10	20	70	20				
STXCR/L 2020 B16-PL	○	●	20	10	20	45	20				
STXCR/L 2020 E16-PL	○	●	20	10	20	70	20				
STXCR/L 2020 H16-PL	○	●	20	10	20	100	20				
								TC.. 16T3..	4015-M3.5x11	80-T15	

R: Sağ / Right / Правый L: Sol/Left/Левый
● Stokta / In Stock / В наличии ○ Stokta Yok / Non Stock Item / Нет в наличии

Sipariş Örneği/Ordering Example/Образец заказа
1 ad./pcs./шт S10X SCMCN 06

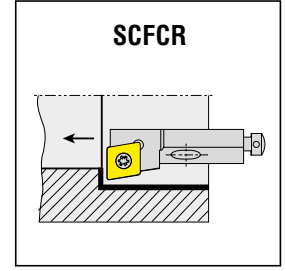
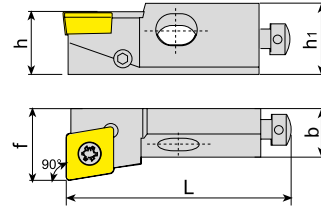
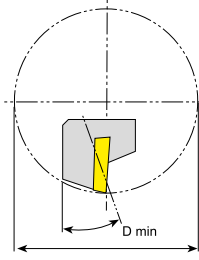

Takım Kodu Ordering Code Код для заказа	Stok Stock Наличие		Takım Ölçüleri (mm) Dimension (mm) Размеры (мм)					Kesici Uç Insert Пластина	Yedek Parçaları / Spare Parts / Залпасные части					
	R	L	h	h1	b	L	f		D min	Altlık Shim Опорная пластина	Altlık Vidası Shim Screw Винт опорной пластины	Sıkma Vidası Screw Зажимной винт	Tork Anahtar Torx Key Торх Ключ	
SCFCR/L 06CA 06	●	●	6	8.5	6	25	8	≥20		-	-	4008-M2.5x6	80-T08	
SCFCR/L 08CA 06	●	●	8	11	8	32	10	≥25		CC.T 060204	-	-	4015-M3.5x11	80-T15
SCFCR/L 10CA 09	●	●	10	15	11	50	14	≥40		CC.T 09T308	-	-	4015-M4.5x11	80-T20
SCFCR/L 12CA 12	●	○	12	20	15	55	20	≥50		CC.T 120408	-	-	4020-M4.5x12	80-T20
SCFCR/L 16CA 12	●	●	16	21	20	63	25	≥60		AACN-2-0003	AAV-10-M4.5x8	4020-M4.5x12	80-T20	

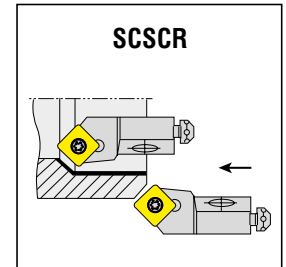
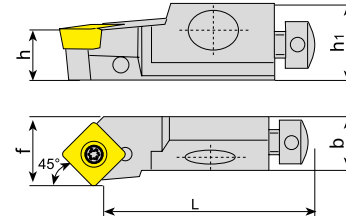
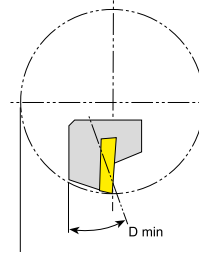

Takım Kodu Ordering Code Код для заказа	Stok Stock Наличие		Takım Ölçüleri (mm) Dimension (mm) Размеры (мм)					Kesici Uç Insert Пластина	Yedek Parçaları / Spare Parts / Залпасные части					
	R	L	h	h1	b	L	f		D min	Altlık Shim Опорная пластина	Altlık Vidası Shim Screw Винт опорной пластины	Sıkma Vidası Screw Зажимной винт	Tork Anahtar Torx Key Торх Ключ	
SCSCR/L 06CA 06	●	○	6	8	6	21	8	≥20		-	-	4008-M2.5x6	80-T08	
SCSCR/L 10CA 09	●	○	10	15	11	44	14	≥40		CC.T 09T308	-	-	4015-M3.5x14	80-T15
SCSCR/L 12CA 12	○	○	12	20	15	47	20	≥50		CC.T 120408	-	-	4015-M4.5x11	80-T15

R: Sağ / Right / Правый L: Sol/Left/Левый

● Stokta / In Stock / В наличии ○ Stokta Yok / Non Stock Item / Нет в наличии

Sipariş Örneği/Ordering Example/Образец заказа

1 ad./pcs./шт SCFCR 06CA 06

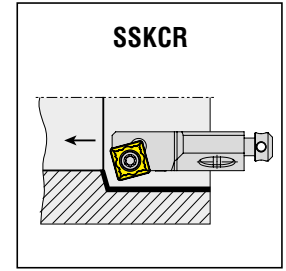
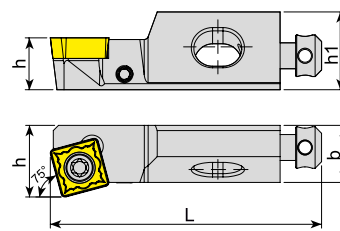
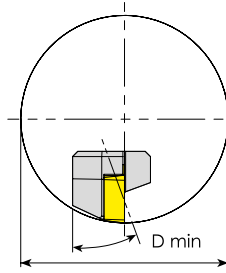

Takım Kodu Ordering Code Код для заказа	Stok Stock Наличие		Takım Ölçüleri (mm) Dimension (mm) Размеры (мм)						Kesici Uç Insert Пластина	Yedek Parçaları / Spare Parts / Запасные части			
	R	L	h	h1	b	L	f	D min		Altık Shim Опорная пластина	Altık Vidası Shim Screw Винт опорной пластины	Sıkma Vidası Screw Зажимной винт	Tork Anahtar Torx Key Торх Ключ
SSKCR/L 10CA 09	●	○	10	15	11	40	14	≥40	SC.T 09T308	-	-	4015-M3.5x11	80-T15
SSKCR/L 12CA 12	●	○	12	20	15	43	20	≥50	SC.T 120408	-	-	4015-M4.5x11	80-T15

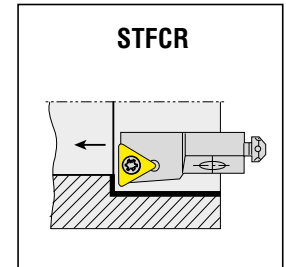
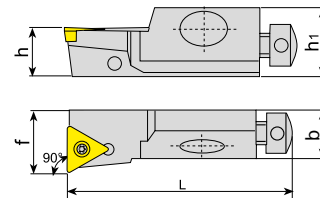
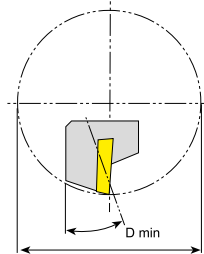

Takım Kodu Ordering Code Код для заказа	Stok Stock Наличие		Takım Ölçüleri (mm) Dimension (mm) Размеры (мм)						Kesici Uç Insert Пластина	Yedek Parçaları / Spare Parts / Запасные части			
	R	L	h	h1	b	L	f	D min		Altık Shim Опорная пластина	Altık Vidası Shim Screw Винт опорной пластины	Sıkma Vidası Screw Зажимной винт	Tork Anahtar Torx Key Торх Ключ
STFCR/L 08CA 09	●	●	8	11	8	32	10	≥25	TC.T 090204	-	-	3007-M2.2x5	80-T07
STFCR/L 10CA 11	●	●	10	15	11	50	14	≥40	TC.T 110204	-	-	4008-M2.5x6	80-T08
STFCR/L 12CA 16	●	○	12	20	15	47	20	≥50	TC.T 16T308	-	-	4015-M3.5x11	80-T15
STFCR/L 16CA 16	●	●	16	21	20	63	25	≥60		AATN-2-0001	AAV-06-M3.5x11	4015-M3.5x14	

R: Sağ / Right / Правый L: Sol/Left/Левый

● Stokta / In Stock / В наличии ○ Stokta Yok / Non Stock Item / Нет в наличии

Sipariş Örneği/Ordering Example/Образец заказа

1 ad./pcs./шт SSKCR 10CA 09

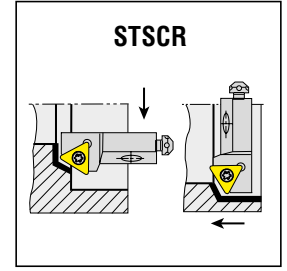
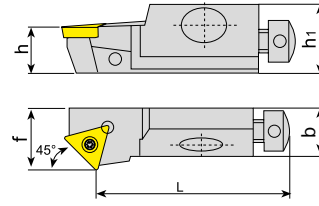
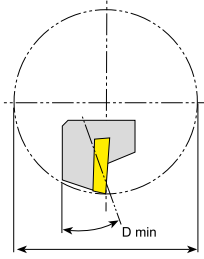

Takım Kodu Ordering Code Код для заказа	Stok Stock Наличие		Takım Ölçüleri (mm) Dimension (mm) Размеры (мм)						Kesici Uç Insert Пластина	Yedek Parçaları / Spare Parts / Запасные части			
	R	L	h	h1	b	L	f	D min		Altık Shim Опорная пластина	Altık Vidası Shim Screw Винт опорной пластины	Sıkma Vidası Screw Зажимной винт	Tork Anahtar Torx Key Торх Ключ
STSCR/L 08CA 09	●	○	8	11	8	28	10	≥25	TC.T 090204	-	-	3007-M2.2x5	80-T07
STSCR/L 10CA 11	●	●	10	15	11	44	14	≥40	TC.T 110204	-	-	4008-M2.5x6	80-T08
STSCR/L 12CA 16	●	○	12	20	15	47	20	≥50	TC.T 16T308	-	-	4015-M3.5x11	80-T15

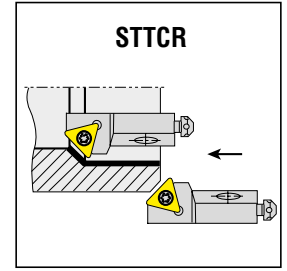
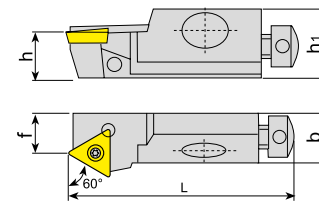
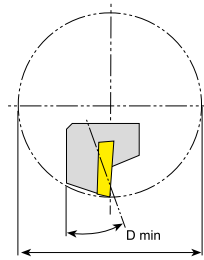

Takım Kodu Ordering Code Код для заказа	Stok Stock Наличие		Takım Ölçüleri (mm) Dimension (mm) Размеры (мм)						Kesici Uç Insert Пластина	Yedek Parçaları / Spare Parts / Запасные части			
	R	L	h	h1	b	L	f	D min		Altık Shim Опорная пластина	Altık Vidası Shim Screw Винт опорной пластины	Sıkma Vidası Screw Зажимной винт	Tork Anahtar Torx Key Торх Ключ
STTCR/L 08CA 09	●	●	8	11	8	32	6	≥25	TC.T 090204	-	-	3007-M2.2x5	80-T07
STTCR/L 10CA 11	●	●	10	15	11	50	9	≥40	TC.T 110204	-	-	4008-M2.5x6	80-T08

R: Sağ / Right / Правый L: Sol/Left/ Левый
● Stokta / In Stock / В наличии ○ Stokta Yok / Non Stock Item / Нет в наличии

Sipariş Örneği/Ordering Example/Образец заказа
1 ad./pcs./шт STSCR 08CA 09

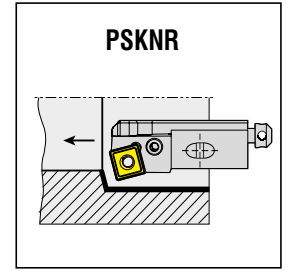
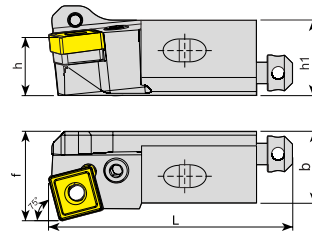
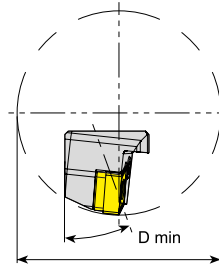

Takım Kodu Ordering Code Код для заказа	Stok Stock Наличие		Takım Ölçüleri (mm) Dimension (mm) Размеры (мм)						Kesici Uç Insert Пластина	Yedek Parçaları / Spare Parts / Запасные части				
	R	L	h	h1	b	L	f	D min		Levyeye Lever Рычаг	Levyeye Vidası Lever Screw Винт рычага	Altılık Shim Опорная пластина	Altılık Yayı Shim Spring Втулка рычага	Anahtar Allen Key Ключ
PSKNR/L 16CA 12	●	●	16	21	20	55	25	≥60						

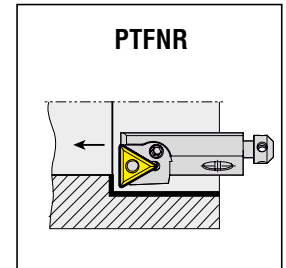
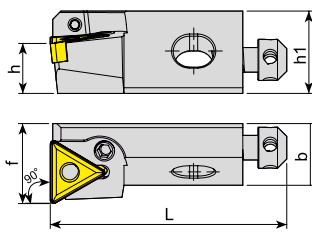
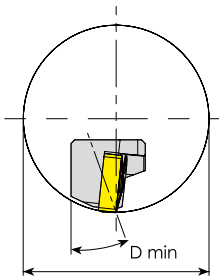

Takım Kodu Ordering Code Код для заказа	Stok Stock Наличие		Takım Ölçüleri (mm) Dimension (mm) Размеры (мм)						Kesici Uç Insert Пластина	Yedek Parçaları / Spare Parts / Запасные части				
	R	L	h	h1	b	L	f	D min		Levyeye Lever Рычаг	Levyeye Vidası Lever Screw Винт рычага	Altılık Shim Опорная пластина	Altılık Yayı Shim Spring Втулка рычага	Anahtar Allen Key Ключ
PTFNR/L 12CA 16	●	●	12	20	15	47	20	≥50				-		
PTFNR/L 16CA 16	●	○	16	21	20	55	25	≥60						

R: Sağ / Right / Правый L: Sol/Left/Левый
● Stokta / In Stock / В наличии ○ Stokta Yok / Non Stock Item / Нет в наличии

Sipariş Örneği/Ordering Example/Образец заказа
1 ad./pcs./шт PSKNR 16CA 12

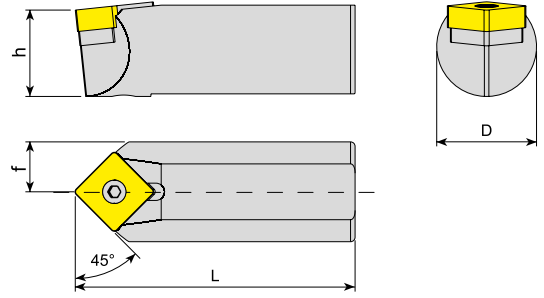

Takım Kodu Ordering Code Код для заказа	Stok Stock Наличие	Takım Ölçüleri (mm) Dimension (mm) Размеры (мм)				Kesici Uç Insert Пластина	Yedek Parçaları / Spare Parts / Запасные части				
		d	h	L	f		Aitlik Shim Опорная пластина	Sıkma Vidası Screw Зажимной винт	Baskı Parçası Wedge Clamp Прижим	Baskı Vidası Clamp Screw Зажимной винт	Anahtar Allen Key Ключ
S22D PSDNN 12C	●	22	19.5	60	11						

R: Sağ / Right / Правый L: Sol/Left/Левый

● Stokta / In Stock / В наличии ○ Stokta Yok / Non Stock Item / Нет в наличии

Sipariş Örneği/Ordering Example/Образец заказа

1 ad./pcs./шт S22D PSDNN 12C

KARTUŞLARIN YEDEK PARÇALARI
SPARE PARTS OF CARTRIDGE
ЗАПАСНЫЕ ЧАСТИ К КАРТРИДЖАМ

Takım Kodu Ordering Code Код для заказа	Yedek Parçaları / Spare Parts / Запасные части					
	Eksenel Ayar Vida Axial Adj. Screw Осевой регулировочный винт	Radyal Ayar Vida Radial Adj. Screw Радиальный регулировочный винт	Radyal Ayar Vida Anahtar Radial Adj. Screw Allen Key Шестигранный ключ для крепления радиального винта	Montaj Vida Mounting Screw Монтажный винт	Montaj Vida Anahtar Mounting Screw Allen Key Монтажный винт со шлицевой головкой под шестигранный ключ	
SCFCR/L	06CA 06	2600-M4x9.5	2715-M3x5	AAL-09-1.5	AKV-23-M4x10	AAL-03-3
SCSCR/L	08CA 06	2600-M4x9.5	2715-M3x5	AAL-09-1.5	AKV-23-M4x10	AAL-03-3
	10CA 09	2600-M5x13	2702-M4x10	AAL-01-2	AKV-02-M6x22	AAL-03-3
	12CA 12	2600-M5x13	2702-M4x10	AAL-01-2	AKV-02-M6x22	AAL-03-3
	16CA 12	2600-M6x18	2725-M5x12	AAL-02-2.5	2005-M8x25	AAL-07-5
STSCR/L	08CA 09	2600-M4x9.5	2715-M3x5	AAL-09-1.5	AKV-23-M4x10	AAL-03-3
STTCR/L	10CA 11	2600-M5x13	2702-M4x10	AAL-01-2	AKV-02-M6x22	AAL-03-3
STFCR/L	12CA 16	2600-M5x13	2702-M4x10	AAL-01-2	AKV-02-M6x22	AAL-03-3
	16CA 16	2600-M6x18	2725-M5x12	AAL-02-2.5	2005-M8x25	AAL-07-5
PTFNR/L	12CA 16	2600-M5x13	2702-M4x4	AAL-01-2	AKV-02-M6x22	AAL-03-3
PSKNR/L	16CA 16	2600-M6x18	2725-M5x6	AAL-02-2.5	2005-M8x25	AAL-07-5
	16CA 12	2600-M6x18	2725-M5x6	AAL-02-2.5	2005-M8x25	AAL-07-5



Takım Kodu Ordering Code Код для заказа	Stok Stock Наличие	Ölçü Aralığı (mm) Boring Range (mm) Диапазон растачивания (мм)					Kartuşlar Cartridge КАРТРИДЖИ	Gövde Takım Kodu Body Tool Code Код головки	Teknik Çizim Technical Draw Технический эскиз
		D max		D min		Max (D dış-D iç) (D out-D in)			
		D iç D in	D dış D out	D iç D in	D dış D out				
ACPBT-1	●	27-52	52	18-36	36	27	ÖTG-K-120-20		
ACPBT-2	●	27-49	52	25-36	36	27			
ACPBT-3	●	48-75	75	41	42	27			
ACPBT-4	●	51-75	75	51	52	27			
ACPBT-5	●	22-35	35	22	23	27			
ACPBT-6	●	15-35	35	15	16	27			
ACPBT-7	●	49-53	75	32-36	36	27			
ACPBT-8	●	49	75	33-37	37	27			

Takım Kodu Ordering Code Код для заказа	Stok Stock Наличие	Ölçü Aralığı (mm) Boring Range (mm) Диапазон растачивания (мм)					Kartuşlar Cartridge КАРТРИДЖИ	Gövde Takım Kodu Body Tool Code Код головки	Teknik Çizim Technical Draw Технический эскиз
		D1		D2		Max (D dış-D iç) (D out-D in)			
		D max	D min	D max	D min				
ACPBT-9	●	38	24	15	1	-	ÖTG-K-120-20		
ACPBT-10	●	78	64	43	29	-			

R: Sağ / Right / Правый L: Sol/Left/Левый

● Stokta / In Stock / В наличии ○ Stokta Yok / Non Stock Item / Нет в наличии

Sipariş Örneği/Ordering Example/Образец заказа

1 ad./pcs./шт ACPBT-1



*konusulan
the spoken kalite...
quality...*

DİŞ AÇMA

DİŞ AÇMA TAKIMLARI

THREADING TOOLHOLDERS

ДЕРЖАВКИ ДЛЯ НАРЕЗАНИЯ НАРУЖНОЙ РЕЗЬБЫ





S **E** **R** **25 25** **M** **16** **C**

1 Sıkma Tipi / Method of Mounting of Insert
 Способ монтажа вставки

S: Vida Sıkmalı
 S: Screw Clamping / S Крепление винтом
 T: Vida Sıkmalı Helis Açılı
 T: Screw Clamping with Helix Angle
 T: Крепление винтом с углом наклона винтовой линии

2 İşlem Tipi / Application
 Виды растачивания

E: Dış / External
 Нарезание для наружной резьбы
 I: İç/Internal / Internal
 Нарезание для внутренней резьбы

3 Kesme Yönü
 Cutting Direction
 Направление резания

R: Sağ Yan
 Right-Hand
 R: Правый

L: Sol Yan
 Left-Hand
 L: Левый

4 Takım Malzemesi / Type of Boring / Сталь Инструмена

"A" Yekpare çelik gövde soğutma suyu kanallı / "A" Solid steel with coolant hole
 "A" Расточная державка из твердой стали с подвожом СОЖ
 "E" Çelik başlıkla sert metal gövde ve soğutma suyu kanallı / "E" Carbide bar with fixed steel head and coolant hole
 "E" Расточная державка из твердосплавного карбида с подвожом СОЖ
 "C" Karbür Şaft / "C" Carbide shank / "C" Расточная державка из твердосплавного карбида
 "S" Çelik Şaft / "S" Steel shank / "S" Расточная державка из твердой стали

4-5 Dış Çap Şaft Ölçüleri
 External Shank Siz
 Сечение державки

Şaft / Shank / державка : hxb
 2525 - 25 x 25 mm

5 Şaft Çapı / Shank Diameter
 Диаметр державки

6 Şaft Boyu / Shank Length / Длина державки

A - 32	H - 100	Q - 180	x-special
B - 40	J - 110	R - 200	
C - 50	K - 125	S - 250	
D - 60	L - 140	T - 300	
E - 70	M - 150	U - 350	
F - 80	N - 160	V - 400	
G - 90	P - 170	W - 450	

7 Elmas Ölçüsü / Insert Size
 Размер пластины

l (mm)	d
06	5/32"
08	3/16"
11	1/4"
16	3/8"
22	1/2"
27	5/8"

8 Baskı Pabucu
 Wedge Clamp
 Прижим клином

S **I** **R** **S** **25** **R** **16** **C**

DIŞ ÇAP DIŞ AÇMA KATERLERİ
EXTERNAL THREADING TOOLHOLDERS
 ДЕРЖАВКА ДЛЯ НАРЕЗАНИЯ НАРУЖНОЙ РЕЗЬБЫ

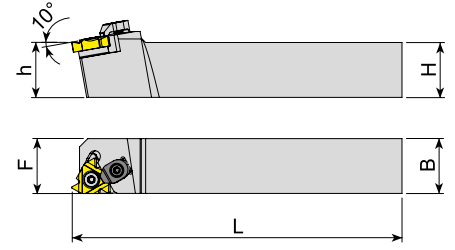
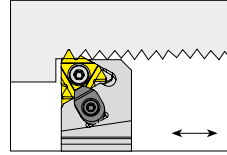

Takım Kodu Ordering Code Код для заказа	Stok Stock Наличие		Takım Ölçüleri (mm) Dimension (mm) Размеры (мм)				Kesici Uç Insert Пластина	Yedek Parçaları / Spare Parts / Запасные части					
	R	L	h=H	B	L	F		Sıkma Vidası Screw Зажимной винт	Altlık Shim Опорная пластина	Altlık Vidası Shim Screw Винт опорной пластины	Baskı Parçası Wedge Clamp Прижим	Baskı Vidası Clamp Screw Зажимной винт	Tork Anahtar Torx Key Torx Ключ
	●	●	●	●	●	●							
SER/L 0808 E11	●	●	08	08	70	11	11 ER/EL	4008-M2.5x6	-	-	-	-	80-T08
SER/L 1010 E11	●	●	10	10	70	11							
SER/L 1212 F11	●	●	12	12	80	12							
SER/L 1616 H11	●	●	16	16	100	16	16 ER/EL (0.35 - 3) ISO METRIC	4015-M3.5x14	AATN-2-0020	AAV-06-M3.5x11	-	-	80-T15
SER/L 1616 H16C	●	●	16	16	100	16							
SER/L 2020 K16C	●	●	20	20	125	20							
SER/L 2525 M16C	●	●	25	25	150	25	22 ER/EL (3.5 - 4.5) ISO METRIC	1020-M4.5x16	AATN-2-0004	AAV-07-M4.5x13	ACK-05	4015 M4x11	80-T20
SER/L 3232 P16C	●	●	32	32	170	32							
SER/L 2525 M22C	●	●	25	25	150	25							
SER/L 3232 P22C	●	●	32	32	170	32	16 ER/L (1.5-3 TR)	4015-M3.5x14	-	-	-	-	80-T15
SER/L 4040 S22C	●	●	40	40	250	40							
SER/L 2525 M16C-T	●	●	25	25	150	25							
SER/L 2525 M22C-T	●	●	25	25	150	25	22 ER/L (4-6 TR)	1020-M4.5x16	-	-	-	-	80-T20
SER/L 2020 K16C-S	●	●	20	20	125	25	SNDVK 166 ER/L16	4015-M3.5x14	AATN-2-0020	AAV-06-M3.5x11	-	-	80-T15
SER/L 2525 M16C-S	●	●	25	25	150	31							
SER/L 3232 P16C-S	●	●	32	32	170	38.5							

DIŞ ÇAP DIŞ AÇMA İSVİÇRE TİPİ KAYAR OTOMAT MAKİNA KATERLERİ
EXTERNAL THREADING TOOLHOLDERS FOR SWISS TYPE SLIDING AUTOMATIC LATHES
 ДЕРЖАВКА ДЛЯ НАРЕЗАНИЯ НАРУЖНОЙ РЕЗЬБЫ ДЛЯ ШВЕЙЦАРСКИХ СТАНКОВ АВТОМАТОВ

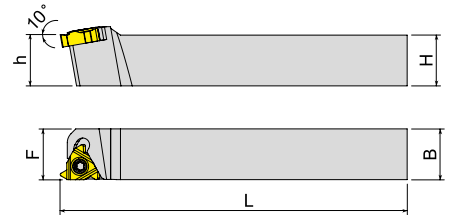
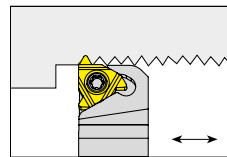

Takım Kodu Ordering Code Код для заказа	Stok Stock Наличие		Takım Ölçüleri (mm) Dimension (mm) Размеры (мм)				Kesici Uç Insert Пластина	Yedek Parçaları / Spare Parts / Запасные части					
	R	L	h=H	B	L	F		Sıkma Vidası Screw Зажимной винт	Altlık Shim Опорная пластина	Altlık Vidası Shim Screw Винт опорной пластины	Baskı Parçası Wedge Clamp Прижим	Baskı Vidası Clamp Screw Зажимной винт	Tork Anahtar Torx Key Torx Ключ
	●	●	●	●	●	●							
SER/L 1010 K11-S	●	●	10	10	125	10	11 ER/EL	4008-M2.5x6	-	-	-	-	80-T08
SER/L 1212 K11-S	●	●	12	12	125	12							

R: Sağ / Right / Правый L: Sol/Left/Левый ● Stokta / In Stock / В наличии ○ Stokta Yok / Non Stock Item / Нет в наличии
 Takımlar standart 1.5° helis açılı olarak üretilir. / The tools have a built in 1.5° helix angle. / Стандартные опорные пластины имеют угол наклона 1.5°
 UYARI / WARNING / ПРЕДУПРЕЖДЕНИЕ: Sayfa 126'deki B ve D figürleri uygulanamaz. / The operation for B and D on page 126 can not be applied. / Операции для B и D на стр. 126 не применяется

Sipariş Örneği/Ordering Example/Образец заказа
 1 ad./pcs./шт SER 0808 E11



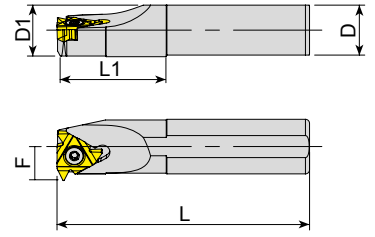
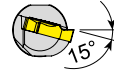
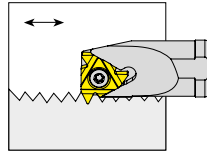

Takım Kodu Ordering Code Код для заказа	Stok Stock Наличие		Takım Ölçüleri (mm) Dimension (mm) Размеры (мм)					Kesici Uç Insert Пластина	Yedek Parçaları / Spare Parts / Запасные части										
	R	L	D	D1	L	L1	F		D min	Sıkma Vidası Screw Зажимной винт	Aitlik Shim Опорная пластина	Aitlik Vidası Shim Screw Винт опорной пластины	Baskı Parçası Wedge Clamp Прижим	Baskı Vidası Clamp Screw Зажимной винт	Tork Anahtar Torx Key Торх Ключ				
SIR/L S12X05H 06	●	○	12	05	100	15	4.3	6.4	06 IR/L	3006-M2x4	-	-	-	-	80-T06				
SIR/L S16X07M 08	●	●	16	07	150	18	5.3	7.8	08 IR/L	3007-M2.2x5	-	-	-	-	80-T07				
SIR/L S10H 11	●	●	10	10	100	-	7.4	12	11 IR/L	4008-M2.5x6	-	-	-	-	80-T08				
SIR/L S12K 11	●	●	12	12	125	-	8.4	16											
SIR/L S16X10M 11	●	●	16	10	150	25	7.4	12											
SIR/L S16X13M 11	●	●	16	13	150	32	8.9	15											
SIR/L S16M 11	●	●	16	16	150	-	11.7	19											
SIR/L S16X13M 16	●	●	16	13	150	32	10.2	16											
SIR/L S16M 16	●	●	16	16	150	-	11.7	19	16 IR/L (0.35 - 3) ISO METRIC	4015-M3.5x9	-	-	-	-	80-T15				
SIR/L S20X16P 16	●	●	20	16	170	40	11.7	19		4015-M3.5x11									
SIR/L S20P 16	●	●	20	20	170	-	13.7	24		4015-M3.5x14						AAV-08-M3.5x8			
SIR/L S25R 16C	●	●	25	25	200	-	16.2	29		4015-M3.5x14						AATN-2-0020	AAV-06-M3.5x11	ACK-05	4015-M4x11
SIR/L S32S 16C	●	●	32	32	250	-	19.7	36		4020-M4.5x12						-	-	-	-
SIR/L S40T 16C	●	●	40	40	300	-	23.7	44		4020-M4.5x12						-	-	-	-
SIR/L S50U 16C	●	●	50	50	350	-	28.7	54	22 IR/L (3.5 - 4.5) ISO METRIC	1020-M4.5x16	AATN-2-0004	AAV-07-M4.5x13	ACK-05	4015-M4x11	80-T20				
SIR/L S20P 22	●	●	20	20	170	-	15.7	24		4015-M3.5x14	-	-	-	-					
SIR/L S25R 22C	●	●	25	25	200	-	18.1	29		4015-M3.5x14	-	-	-	-					
SIR/L S32S 22C	●	●	32	32	250	-	21.6	38	16 IR/L (1.5-3 TR)	4015-M3.5x14	-	-	-	-	80-T15				
SIR/L S40T 22C	●	●	40	40	300	-	25.6	46											
SIR/L S50U 22C	●	●	50	50	350	-	30.6	58	22 IR/L (4-6 TR)	1020-M4.5x16	-	-	-	-	80-T20				
SIR/L S25R 16C-T	●	●	25	25	200	-	16.2	29											
SIR/L S32S 16C-T	●	●	32	32	250	-	19.7	36											
SIR/L S25R 22C-T	●	●	25	25	200	-	18.1	29											
SIR/L S32S 22C-T	●	●	32	32	250	-	21.6	38											

R: Sağ / Right / Правый L: Sol/Left/Левый ● Stokta / In Stock / В наличии ○ Stokta Yok / Non Stock Item / Нет в наличии

Takımlar standart 1.5° helis açılı olarak üretilir. / The tools have a built in 1.5° helix angle. / Стандартные опорные пластины имеют угол наклона 1.5°

UYARI / WARNING / ПРЕДУПРЕЖДЕНИЕ: Sayfa 127'deki B ve D figürleri uygulanamaz. / The operation for B and D on page 127 can not be applied. / Операции для B и D на стр. 127 не применяются

Sipariş Örneği/Ordering Example/Образец заказа

1 ad./pcs./шт SIR S12X05H 06

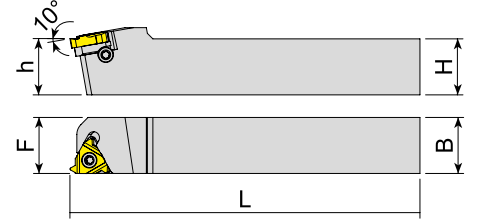
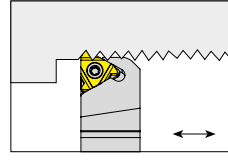

Takım Kodu Ordering Code Код для заказа	Stok Stock Наличие		Takım Ölçüleri (mm) Dimension (mm) Размеры (мм)				Kesici Uç Insert Пластина	Yedek Parçaları / Spare Parts / Запасные части						
	R	L	h=H	B	L	F		Sıkma Vidası Screw Зажимной винт	Sağ Altlık Right Shim Правая опорная пластина	Sol Altlık Left Shim Левая опорная пластина	Altlık Vidası Shim Screw Винт опорной пластины	Baskı Parçası Wedge Clamp Прижим	Baskı Vidası Clamp Screw Зажимной винт	Tork Anahtar Torx Key Торх Ключ
TER/L 1616 H16	●	●	16	16	100	16	16 ER/EL							
TER/L 2020 K16	●	●	20	20	125	20								
TER/L 2525 M16	●	●	25	25	150	25								
TER/L 3232 P16	●	●	32	32	170	32	22 ER/EL							
TER/L 2525 M22	●	●	25	25	150	25								
TER/L 3232 P22	●	●	32	32	170	32								
TER/L 4040 S22	●	●	40	40	250	40	27 ER/EL							
TER/L 2525 M27	●	●	25	25	150	25								
TER/L 3232 P27	●	●	32	32	170	32								
TER/L 4040 S27	●	●	40	40	250	40								

R: Sağ / Right / Правый L: Sol/Left/Левый ● Stokta / In Stock / В наличии ○ Stokta Yok / Non Stock Item / Нет в наличии
 Takımlar standart 1.5° helis açılı olarak üretilir. / The tools have a built in 1.5° helix angle. / Стандартные опорные пластины имеют угол наклона 1.5°

Sipariş Örneği/Ordering Example/Образец заказа
 1 ad./pcs./шт TER 1616 H16

DIŞ ÇAP SAĞ YÖNDE VİDA AÇMA
EXTERNAL RIGHT HAND THREADING OPERATION
 НАРЕЗАНИЕ ПРАВОЙ НАРУЖНОЙ РЕЗЬБЫ

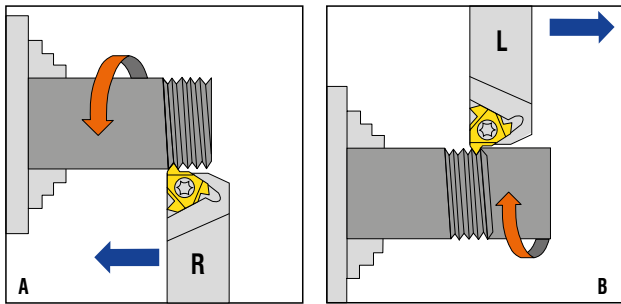

DIŞ ÇAP SOL YÖNDE VİDA AÇMA
EXTERNAL LEFT HAND THREADING OPERATION
 НАРЕЗАНИЕ ЛЕВОЙ НАРУЖНОЙ РЕЗЬБЫ

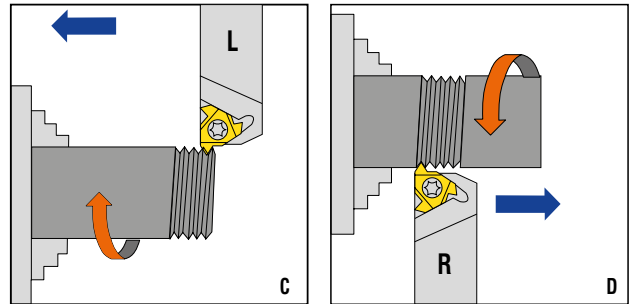

UYARI / WARNING / ВНИМАНИЕ

Figür B ve D için; negatif açılı altlık kullanılmalıdır. / For figure B and D; negative shim must be used. / Для схем B и D необходимо использовать отрицательную подложку под резьбовую пластину
 Altıksız katerlerde B ve D figürü uygulanamaz. / B and D figures can not be applied on tools without shim. / Схемы B и D нельзя применять без подкладки под резьбовую пластину

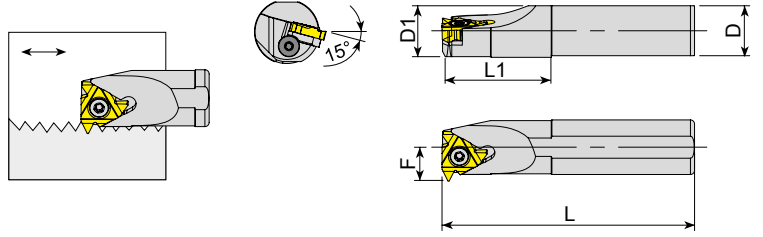

Takım Kodu Ordering Code Код для заказа	Stok Stock Наличие		Takım Ölçüleri (mm) Dimension (mm) Размеры (мм)					Kesici Uç Insert Пластина	Yedek Parçaları / Spare Parts / Запасные части							
	R	L	D	D1	L	L1	F		D min	Sıkma Vidası Screw Зажимной винт	Sol Aitlik Left Shim Левая опорная пластина	Sağ Aitlik Right Shim Правая опорная пластина	Aitlik Vidası Shim Screw Винт опорной пластины	Baskı Parçası Wedge Clamp Прижим	Baskı Vidası Clamp Screw Зажимной винт	Tork Anahtar Torx Key Торх Ключ
TIR/L S25R 16	●	●	25	25	200	-	16.2	29	16 IR/L	1710-U5-40x12.2	ATS-16E	ATS-16I	AAV-11-U5-40x4.5	-	-	80-T10
TIR/L S32S 16	●	●	32	32	250	-	19.7	36								
TIR/L S40T 16	●	●	40	40	300	-	23.7	44								
TIR/L S50U 16	●	●	50	50	350	-	28.7	54								
TIR/L S25R 22	●	●	25	25	200	-	18.1	29	22 IR/L	1720-U8-32x15	ATS-22E	ATS-22I	AAV-12-U8-32x5.5	-	-	80-T20
TIR/L S32S 22	●	●	32	32	250	-	21.6	38								
TIR/L S40T 22	●	●	40	40	300	-	25.6	46								
TIR/L S50U 22	●	●	50	50	350	-	30.6	58								
TIR/L S32S 27	●	●	32	32	250	-	22.6	40	27 IR/L	1620-M5x18	ATS-27E	ATS-27I	AAV-15-M5x5.7	-	-	80-T20
TIR/L S40T 27	●	●	40	40	300	-	26.6	48		1620-M5x22						
TIR/L S50U 27	●	●	50	50	350	-	31.6	58								

R: Sağ / Right / Правый L: Sol/Left/Левый ● Stokta / In Stock / В наличии ○ Stokta Yok / Non Stock Item / Нет в наличии
Takımlar standart 1.5° helis açılı olarak üretilir. / The tools have a built in 1.5° helix angle. / Стандартные опорные пластины имеют угол наклона 1.5°

Sipariş Örneği/Ordering Example/Образец заказа
1 ad./pcs./шт TIR S25R 16

DELİK İÇİ SAĞ YÖNDE VİDA AÇMA
INTERNAL RIGHT HAND THREADING OPERATION
НАРЕЗАНИЕ ПРАВОЙ ВНУТРЕННЕЙ РЕЗЬБЫ

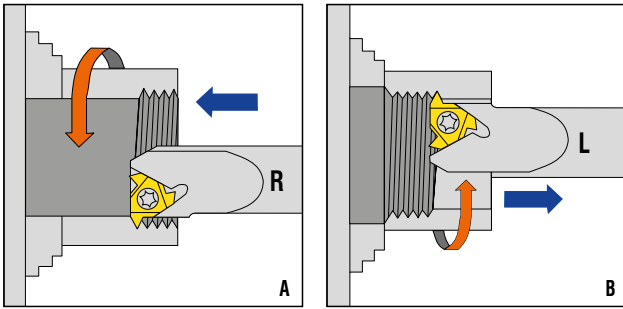

DELİK İÇİ SOL YÖNDE VİDA AÇMA
INTERNAL LEFT HAND THREADING OPERATION
НАРЕЗАНИЕ ЛЕВОЙ ВНУТРЕННЕЙ РЕЗЬБЫ

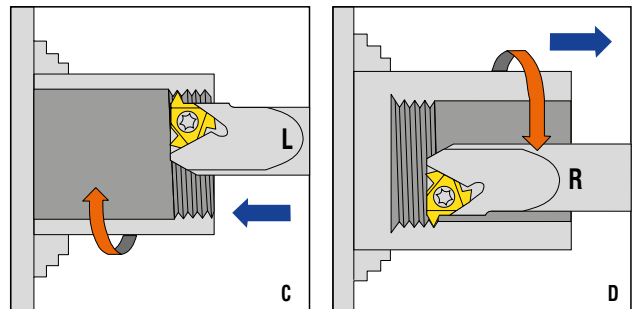

UYARI / WARNING / ВНИМАНИЕ
Figür B ve D için; negatif açılı altlık kullanılmalıdır. / For figure B and D; negative shim must be used. / Для схем B и D необходимо использовать отрицательную подложку под резьбовую пластину
Altıksız katerlerde B ve D figürü uygulanamaz. / B and D figures can not be applied on tools without shim. / Схемы B и D нельзя применять без подкладки под резьбовую пластину

Diş Helis Açısı Thread Helix Angle Угол подъема резьбы

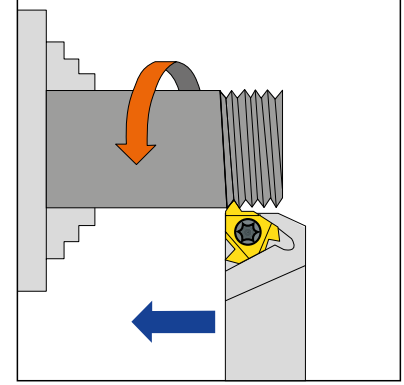
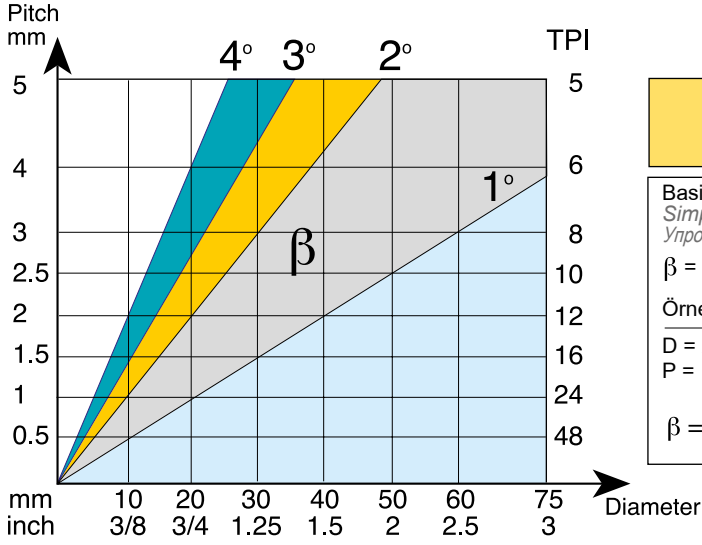

Standart ve Eğik Altlıklar Standard and Slanted Shim

Стандартная и наклонная опорная пластина

Akko diş açma takımlarının, uç yuvaları 1.5° helis açılı olarak üretilir. Farklı helis açılı diş açmak isteyenler altlığı değiştirerek istedikleri dereceyi elde edebilirler. Negatif helis genellikle sol katerde sağ diş çekmek için kullanılır ya da sağ katerde sol diş çekmek için kullanılır.

Akko Toolholders Pockets have a built in 1.5° helix angle. This angle may be adjusted to better match the thread helix angle by simply changing the shim.

Negative helix is usually used when threading RH thread with LH Holder or LH thread with RH Holder.

Державки АККО имеют стандартный угол наклона опорной пластины 1,5°. Этот угол можно отрегулировать путем замены опорной пластины. Отрицательный угол наклона обычно используется когда правая резьба RH нарезается левой державкой LH или левая резьба LH нарезается правой державкой RH.

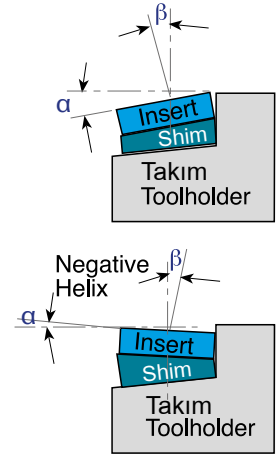

L	IC	Takım Tipi Tool Type Тип Инструмента	Uç Yuvasının Açısı (α) / Pocket's Angle (α) / Угол наклона (α)						
			4.5°	3.5°	2.5°	1.5°	0.5°	-0.5°	-1.5°
16	3/8	EX-RH or IN-LH	ATS-16E+4.5	ATS-16E+3.5	ATS-16E+2.5	ATS-16E	ATS-16E+0.5	ATS-16E-0.5	ATS-16E-1.5
16	3/8	EX-LH or IN-RH	ATS-16I+4.5	ATS-16I+3.5	ATS-16I+2.5	ATS-16I	ATS-16I+0.5	ATS-16I-0.5	ATS-16I-1.5
22	1/2	EX-RH or IN-LH	ATS-22E+4.5	ATS-22E+3.5	ATS-22E+2.5	ATS-22E	ATS-22E+0.5	ATS-22E-0.5	ATS-22E-1.5
22	1/2	EX-LH or IN-RH	ATS-22I+4.5	ATS-22I+3.5	ATS-22I+2.5	ATS-22I	ATS-22I+0.5	ATS-22I-0.5	ATS-22I-1.5
27	5/8	EX-RH or IN-LH	ATS-27E+4.5	ATS-27E+3.5	ATS-27E+2.5	ATS-27E	ATS-27E+0.5	ATS-27E-0.5	ATS-27E-1.5
27	5/8	EX-LH or IN-RH	ATS-27I+4.5	ATS-27I+3.5	ATS-27I+2.5	ATS-27I	ATS-27I+0.5	ATS-27I-0.5	ATS-27I-1.5

Altlık Değişirme Öneri Tablosu / Shim Change Recommendation Рекомендации по смене опорной пластины

Tabloda da görüldüğü gibi bazı diş hatvelerinin çaplara göre kombinasyonları altlık değişimini gerektirir. Eğer değişim gerekli ise EX-RH ve IN-LH katerleri için ATS-E altlıklarını, IN-RH ve EX-LH katerleri için ATS-I altlıklarını kullanın.
 As can be seen from the chart, some Pitch to Diameter combinations require a shim change. If change is required, use ATS-E shim for EX-RH and IN-LH toolholders and ATS-I shims for IN-RH and EX-LH toolholders.

Как видно из диаграммы, некоторые комбинации Шаг на Диаметр требуют замены опорной пластины. Если требуется замена, используйте опорные пластины ATS-E для державок инструментов EX-RH и IN-LH и опорные пластины ATS-I для державок IN-RH и EX-LH.

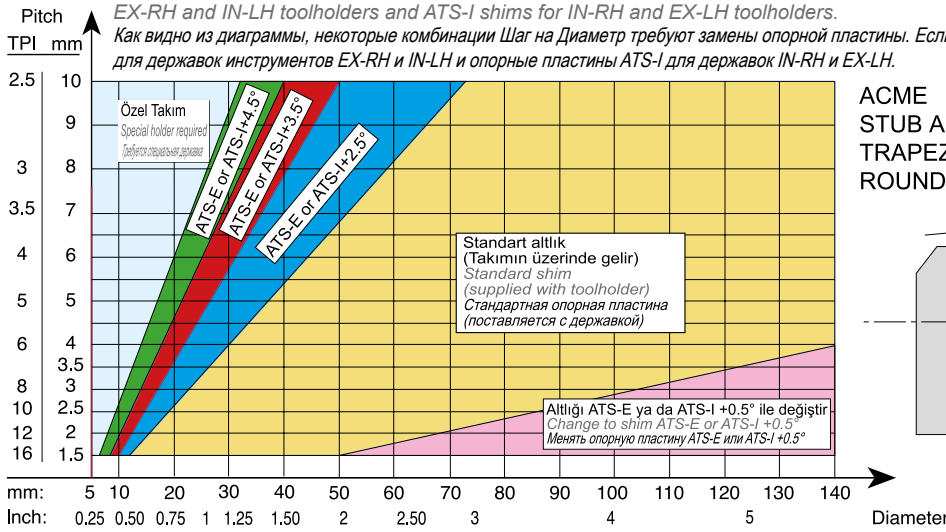

ACME
 STUB ACME
 TRAPEZ (DIN 103)
 ROUND (DIN 405)

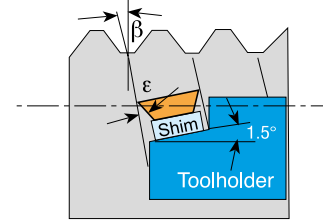

Tabloda da görüldüğü gibi çoğu uygulamalar altlık değişimine ihtiyaç duymaz. Eğer değişime ihtiyaç duyulursa EX-RH ve IN-LH katerleri için ATS-E altlıklarını, IN-RH ve EX-RH katerleri için ATS-I altlıklarını kullanın.

As can be seen from the chart, most applications do not require a shim change. If change is required, use ATS-E shims for EX-RH and IN-LH toolholders and ATS-I shims for IN-RH and EX-LH toolholders.

Как видно из диаграммы, некоторые комбинации Шаг на Диаметр требуют замены опорной пластины. Если требуется замена, используйте опорные пластины ATS-E для державок инструментов EX-RH и IN-LH и опорные пластины ATS-I для державок IN-RH и EX-LH.

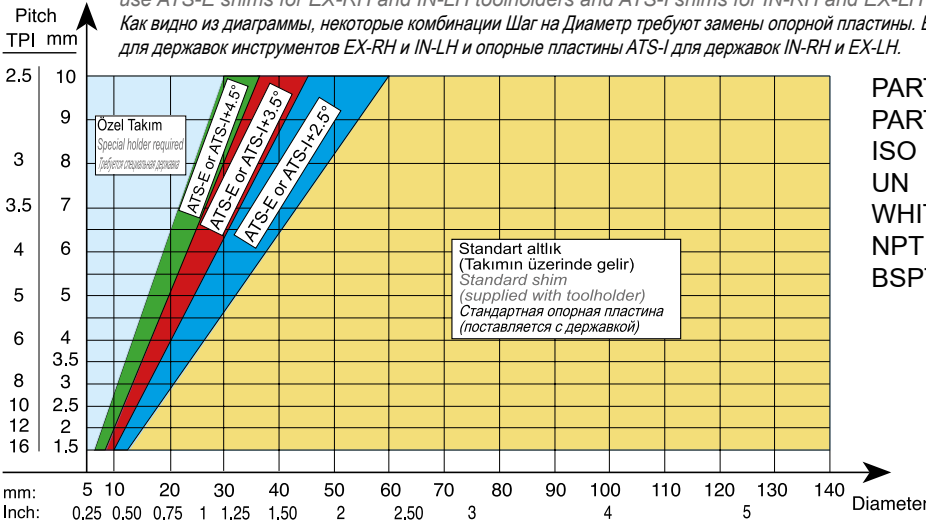

PARTIAL PROFILES 60°
 PARTIAL PROFILES 55°
 ISO
 UN
 WHIT.
 NPT
 BSPT

Tabloda da görüldüğü gibi çoğu uygulamalar altlık değişimine ihtiyaç duyar. Çoğu durumda negatif bir altlığı ihtiyaç duyulur. EX-RH ve IN-LH takımlar için ATS-E altlıklarını kullanın. IN-RH ve EX-LH takımlar için ATS-I altlıklarını kullanın.

As can be seen from the chart, most applications require a shim change. In most cases a negative shim is required, use ATS-E shims for EX-RH and IN-LH toolholders. ATS-I shims for IN-RH and EX-LH toolholders.

Как видно из диаграммы, в большинстве случаев требуется смена опорной пластины. В основном применяется отрицательная опорная пластина, используйте опорные пластины ATS-E для державок EX-RH и IN-LH. Опорные пластины ATS-I для державок IN-RH и EX-LH.

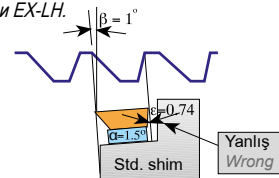
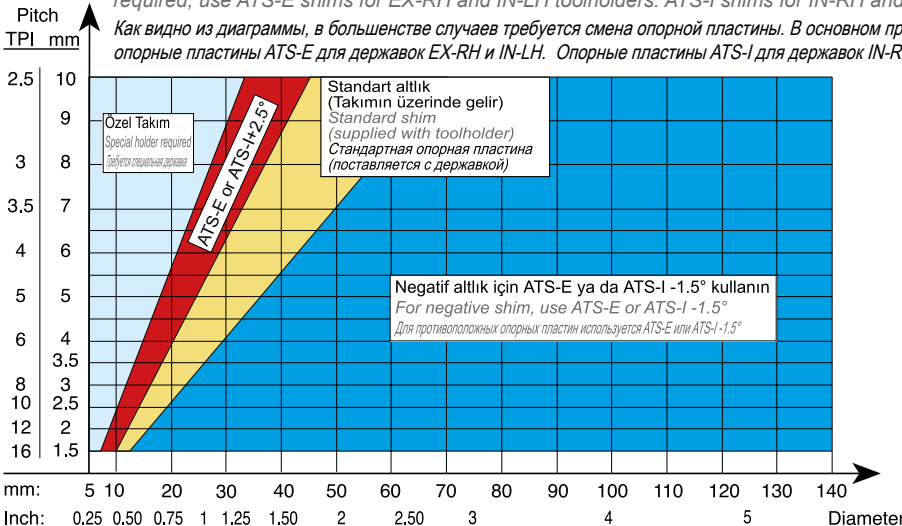

Before Shim Change
 Altlığı Değişirmeden Önce
 До смены опорной пластины

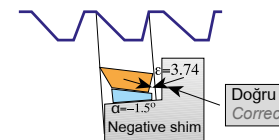

After Shim Change
 Altlığı Değiştirdikten Sonra
 После смены опорной пластины

AMERICAN
 BUTTRESS
 SAGENGWINDE
 (DIN 513)

Standart altlığın negatif bir altlıkla değiştirilmesi, kenar sürtmesini engelleyecektir.

Replacing the standard shim with a shim has negative angle, will eliminate side rubbing

Смена стандартной опорной пластины на пластину с отрицательным углом устраняет боковое трение

*konusulan
the spoken kalite...
quality...*

KANAL AÇMA

KANAL AÇMA TAKIMLARI
GROOVING TOOLHOLDERS
ДЕРЖАВКИ ДЛЯ ОБРАБОТКИ КАНАВОК





AKKO **A** **AKT** - **K** - **R** - **2525**

100 - 150 - **4** - **T22**

2 Kesici Stili / Cutter Style / Тип режущего инструмента

DKT: Dış Çap Kanal Açma Takımı / External Grooving Toolholders
ДЕРЖАВКИ ДЛЯ ОБРАБОТКИ НАРУЖНЫХ КАНАВOK
IKT: Delik İçi Kanal Açma Takımı / Internal Grooving Toolholders
ДЕРЖАВКИ ДЛЯ ОБРАБОТКИ ВНУТРЕННИХ КАНАВOK
AKT: Dış Çap Alın Kanal Takımları / Face Grooving Toolholders
ДЕРЖАВКА ДЛЯ ОБРАБОТКИ ТОРЦЕВЫХ КАНАВOK
LKT: L Tip Alın Kanal Açma Takımı / L Type Face Grooving Toolholders
ДЕРЖАВКА L-ТИПА ДЛЯ ОБРАБОТКИ ТОРЦЕВЫХ КАНАВOK

3 Uç Tipi / Insert Type / Форма пластины

KRLY / MGM.
HRN / S312, S229, S224, S223
ISCR / DGN, GI, GTN
SNDVK / 123, 151, 154.91
ZCC
KM / A4.
ARN / LOMR.

TGTC / TD.

4 Kesme Yönü / Cutting Direction
Направление резания

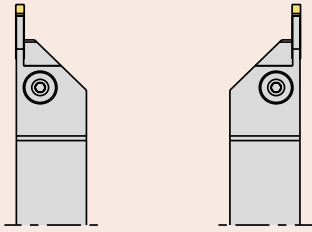

R

L

5 Kesme Kenar Yüksekliği ve Şaft Genişliği
Cutting Edge Height and Shank Width
Высота и Ширина державки

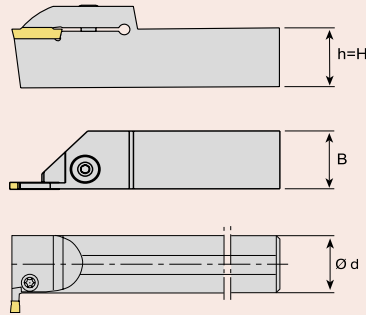

6 Kesme Aralığı
Cutting Diameter
Диаметр Резание

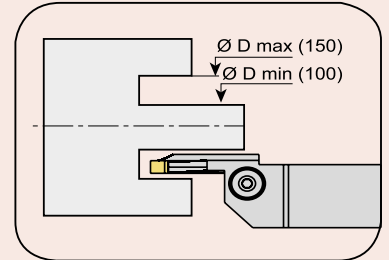

7 Kesme Kenar Genişliği / Cutting Width Edge
Длина режущей кромки

ÖR/EG :
2 = 2.0 mm
3 = 3.0 mm
4 = 4.0 mm
5 = 5.0 mm
6 = 6.0 mm
8 = 8.0 mm

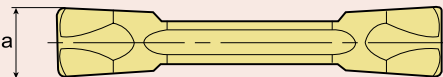

8 Kesme Derinliği / Cutting Depth

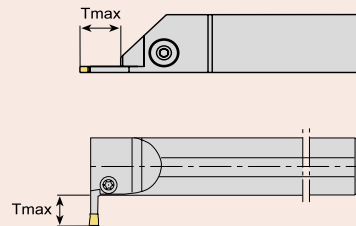

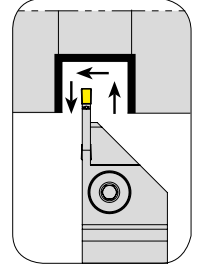
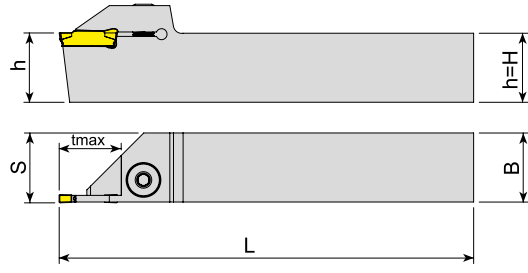

Takım Kodu Ordering Code Код для заказа	Stok Stock Наличие		Takım Ölçüleri (mm) Dimension (mm) Размеры (мм)				Kesici Uç Insert Пластина	Yedek Parçaları / Spare Parts / Запасные части			
	R	L	h=H	B	L	S		tmax	Sıkma Vidası Screw Зажимной винт	Pul Stamp Шайба	Anahtar Allen Key Ключ
ADKT-K-R/L-1212-1.5-T15	●	●	12	12	100	12.2	15	MGM. - 1.5			
ADKT-K-R/L-1212-2-T15	●	●	12	12	100	16.3	15				
ADKT-K-R/L-1616-2-T15	●	●	16	16	125	16.3	15				
ADKT-K-R/L-2020-2-T15	●	●	20	20	125	20.3	15				
ADKT-K-R/L-2525-2-T15	●	●	25	25	150	25.3	15				
ADKT-K-R/L-3232-2-T15	●	●	32	32	170	32.3	15				
ADKT-K-R/L-1212-3-T15	●	●	12	12	100	16.3	15	MGM. - 3			
ADKT-K-R/L-1616-3-T15	●	●	16	16	125	16.4	15				
ADKT-K-R/L-2020-3-T20	●	●	20	20	125	20.4	20				
ADKT-K-R/L-2020-3-R28	●	●	20	20	125	20.3	28				
ADKT-K-R/L-2525-3-R15	●	●	25	25	150	25.4	15				
ADKT-K-R/L-2525-3-T22	●	●	25	25	150	25.4	22				
ADKT-K-R/L-3232-3-T22	●	●	32	32	170	32.4	22	MGM. - 4	2004-M8x1x20	-	AAL-05-4
ADKT-K-R/L-2020-4-T20	●	●	20	20	125	20.4	20				
ADKT-K-R/L-2020-4-R25	●	○	20	20	125	20.4	25				
ADKT-K-R/L-2525-4-T18	●	●	25	25	150	25.4	18				
ADKT-K-R/L-2525-4-T22	●	●	25	25	150	25.4	22				
ADKT-K-R/L-3232-4-T22	●	●	32	32	170	32.4	22				
ADKT-K-R/L-2020-5-T20	●	●	20	20	125	20.5	20	MGM. - 5			
ADKT-K-R/L-2525-5-T18	●	●	25	25	150	25.5	18				
ADKT-K-R/L-2525-5-T25	●	●	25	25	150	25.5	25				
ADKT-K-R/L-3232-5-T25	●	●	32	32	170	32.5	25	MGM. - 6			
ADKT-K-R/L-2525-6-T25	●	●	25	25	150	25.6	25				
ADKT-K-R/L-3232-6-T25	●	●	32	32	170	32.6	25	MGM. - 8			
ADKT-K-R/L-3232-8-T32	●	●	32	32	170	32.8	32				

R: Sağ / Right / Правый L: Sol/Left/Левый

● Stokta / In Stock / В наличии ○ Stokta Yok / Non Stock Item / Нет в наличии

KRLY - JD Ucuna Uygundur. / Compatible with KRLY - JD Insert. / Под пластину KRLY - JD

Sipariş Örneği/Ordering Example/Образец заказа

1 ad./pcs./шт ADKT-K-R-1212-2-T15

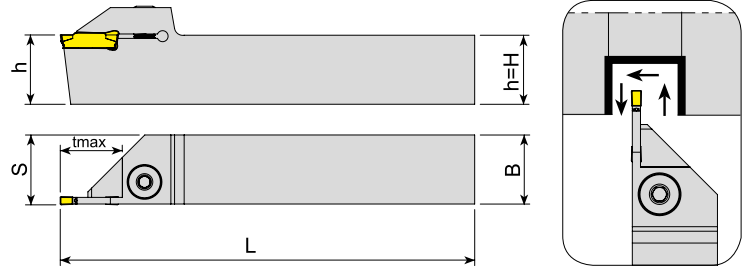

Takım Kodu Ordering Code Код для заказа	Stok Stock Наличие		Takım Ölçüleri (mm) Dimension (mm) Размеры (мм)					Kesici Uç Insert Пластина	Yedek Parçaları / Spare Parts / Запасные части		
	R	L	h=H	B	L	S	t max		Sıkma Vidası Screw Зажимной винт	Pul Stamp Шайба	Anahtar Allen Key Ключ
ADKT-KG-R/L-2020-2-T15	●	●	20	20	125	20.2	15	KG.. - 2	AKV-02-M6x22	ABPL-01	AAL-03-3
ADKT-KG-R/L-2525-2-T15	●	○	25	25	150	25.2	15				
ADKT-KG-R/L-2525-2-T17	●	○	25	25	150	25.2	17				
ADKT-KG-R/L-1616-3-T20	●	●	16	16	125	16.3	20	KG.. - 3	2004-M8x1x20	-	AAL-05-4
ADKT-KG-R/L-2020-3-T20	●	●	20	20	125	20.3	20				
ADKT-KG-R/L-2525-3-T22	●	●	25	25	150	25.3	22				
ADKT-KG-R/L-2020-4-T20	●	●	20	20	125	20.4	20	KG.. - 4	2004-M8x1x20	-	AAL-05-4
ADKT-KG-R/L-2525-4-T16	●	○	25	25	150	25.4	16				
ADKT-KG-R/L-2525-4-T22	●	○	25	25	150	25.4	22				
ADKT-KG-R/L-2525-5-T25	●	○	25	25	150	25.5	25	KG.. - 5	2004-M8x1x20	-	AAL-05-4
ADKT-KG-R/L-2525-6-T25	○	○	25	25	150	25.6	25	KG.. - 6			

KRLRY Ucuna Uygundur. / Compatible with KRLRY Insert. / Под пластину KRLRY

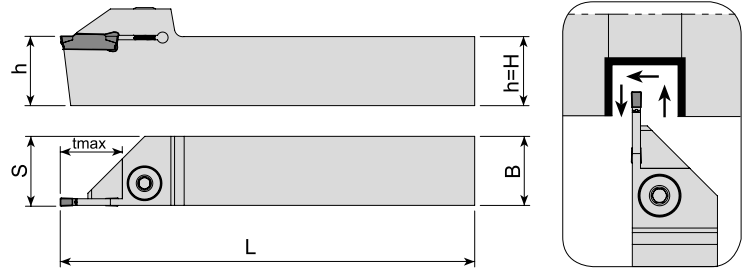

Takım Kodu Ordering Code Код для заказа	Stok Stock Наличие		Takım Ölçüleri (mm) Dimension (mm) Размеры (мм)					Kesici Uç Insert Пластина	Yedek Parçaları / Spare Parts / Запасные части		
	R	L	h=H	B	L	S	t max		Sıkma Vidası Screw Зажимной винт	Pul Stamp Шайба	Anahtar Allen Key Ключ
ADKT-SGC-R/L-1212-2-R15	●	●	12	12	100	16.2	15	GCM N20	AKV-02-M6x22	ABPL-01	AAL-03-3
ADKT-SGC-R/L-1616-2-R15	●	●	16	16	125	16.2	15				
ADKT-SGC-R/L-2020-2-R20	●	●	20	20	125	20.2	20				
ADKT-SGC-R/L-2525-2-R20	●	●	25	25	150	25.2	20	GCM N30	2004-M8x1x20	-	AAL-05-4
ADKT-SGC-R/L-1212-3-R15	●	●	12	12	100	16.3	15				
ADKT-SGC-R/L-1616-3-R15	●	●	16	16	125	16.3	15				
ADKT-SGC-R/L-2020-3-R22	●	●	20	20	125	20.3	22	GCM N40	2004-M8x1x20	-	AAL-05-4
ADKT-SGC-R/L-2525-3-R15	●	○	25	25	150	25.3	15				
ADKT-SGC-R/L-2525-3-R22	●	●	25	25	150	25.3	22				
ADKT-SGC-R/L-2525-4-R25	●	○	25	25	150	25.4	25	KG.. - 5	2004-M8x1x20	-	AAL-05-4

R: Sağ / Right / Правый L: Sol/Left/Левый

● Stokta / In Stock / В наличии ○ Stokta Yok / Non Stock Item / Нет в наличии

SMTM Ucuna Uygundur. / Compatible with SMTM Insert. / Под пластину SMTM

Sipariş Örneği/Ordering Example/Образец заказа

1 ad./pcs./шт ADKT-KG-R-2020-2-T15

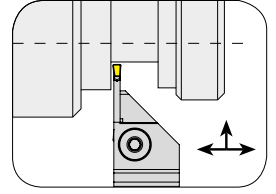
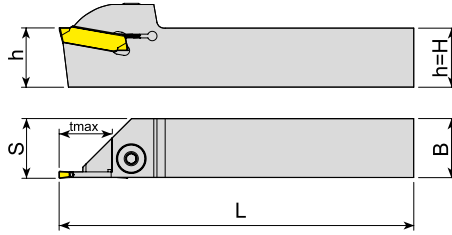

Takım Kodu Ordering Code Код для заказа	Stok Stock Наличие		Takım Ölçüleri (mm) Dimension (mm) Размеры (мм)					Kesici Uç Insert Пластина	Yedek Parçaları / Spare Parts / Запасные части			
	R	L	h=H	B	L	S	t max		Sıkma Vidası Screw Зажимной винт	Pul Stamp Шайба	Anahtar Allen Key Ключ	
ADKT-H-R/L-2020-3-T20	●	●	20	20	125	20.5	20	S229 - 3	2004-M8x1x20	-	AAL-05-4	
ADKT-H-R/L-2525-3-T22	●	●	25	25	150	25.5	22					
ADKT-H-R/L-2525-3-T26	●	●	25	25	150	25.5	26					
ADKT-H-R/L-2020-4-T20	●	●	20	20	125	20.5	20	S229 - 4	2004-M8x1x20	-	AAL-05-4	
ADKT-H-R/L-2525-4-T22	●	●	25	25	150	25.5	22					
ADKT-H-R/L-3232-4-T22	●	●	32	32	170	32.5	22					
ADKT-H-R/L-2020-5-T20	●	●	20	20	125	20.5	20	S229 - 5	2004-M8x1x20	-	AAL-05-4	
ADKT-H-R/L-2525-5-T25	●	●	25	25	150	25.5	25					
ADKT-H-R/L-2525-6-T25	●	●	25	25	150	25.6	25					

HRN Ucuna Uygundur. / Compatible with HRN Insert. / Под пластину HRN

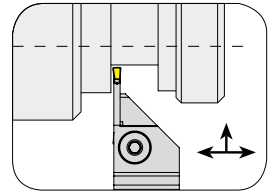
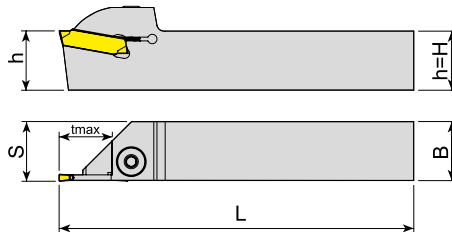

Takım Kodu Ordering Code Код для заказа	Stok Stock Наличие		Takım Ölçüleri (mm) Dimension (mm) Размеры (мм)					Kesici Uç Insert Пластина	Yedek Parçaları / Spare Parts / Запасные части			
	R	L	h=H	B	L	S	t max		Sıkma Vidası Screw Зажимной винт	Pul Stamp Шайба	Anahtar Allen Key Ключ	
ADKT-HK-R/L-1616-2-T15	●	●	16	16	125	16.3	15	S224 - 2	AKV-02-M6x22	ABPL-01	AAL-03-3	
ADKT-HK-R/L-2020-2-T15	●	●	20	20	125	20.3	15					
ADKT-HK-R/L-2525-2-T15	●	●	25	25	150	25.3	15					
ADKT-HK-R/L-1616-3-T15	○	○	16	16	125	16.3	15	S224 - 3	2004-M8x1x20	-	AAL-05-4	
ADKT-HK-R/L-2020-3-T20	●	●	20	20	125	20.4	20					
ADKT-HK-R/L-2525-3-T22	●	●	25	25	150	25.4	22					
ADKT-HK-R/L-2020-4-T20	●	●	20	20	125	20.4	20	S224 - 4	2004-M8x1x20	-	AAL-05-4	
ADKT-HK-R/L-2525-4-T22	●	●	25	25	150	25.4	22					
ADKT-HS223-R/L-2020-2-T15	●	○	20	20	125	20.4	15					
ADKT-HS223-R/L-2020-3-T17	●	○	20	20	125	20.3	17	S223 - 2	AKV-02-M6x22	ABPL-01	AAL-03-3	
								S223 - 3	2004-M8x1x20	-	AAL-05-4	

R: Sağ / Right / Правый L: Sol/Left/Левый

● Stokta / In Stock / В наличии ○ Stokta Yok / Non Stock Item / Нет в наличии

HRN Ucuna Uygundur. / Compatible with HRN Insert. / Под пластину HRN

Sipariş Örneği/Ordering Example/Образец заказа

1 ad./pcs./шт ADKT-H-R-2020-3-T20

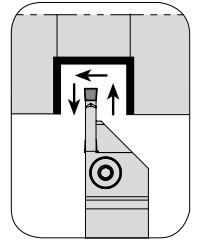
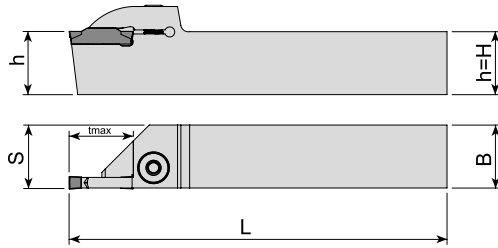

Takım Kodu Ordering Code Код для заказа	Stok Stock Наличие		Takım Ölçüleri (mm) Dimension (mm) Размеры (мм)					Kesici Uç Insert Пластина	Yedek Parçaları / Spare Parts / Запасные части		
	R	L	h=H	B	L	S	t max		Sıkma Vidası Screw Зажимной винт	Pul Stamp Шайба	Anahtar Allen Key Ключ
ADKT-ZCC2-R/L-1616-2-T15	●	●	16	16	125	16.3	15	Z.BD - 2	AKV-02-M6x22	ABPL-01	AAL-03-3
ADKT-ZCC2-R/L-2020-2-T15	●	●	20	20	125	20.3	15				
ADKT-ZCC2-R/L-2525-2-T15	●	●	25	25	150	25.3	15				
ADKT-ZCC2-R/L-1616-2.5-T15	●	●	16	16	125	16.3	15	Z.ED - 2.5	2004-M8x1x20	-	AAL-05-4
ADKT-ZCC2-R/L-2020-2.5-T17	●	●	20	20	125	20.3	17				
ADKT-ZCC2-R/L-2525-2.5-T15	●	●	25	25	150	25.3	15				
ADKT-ZCC2-R/L-1616-3-T15	●	●	16	16	125	16.3	15	Z.FD - 3	2004-M8x1x20	-	AAL-05-4
ADKT-ZCC2-R/L-1616-3-T17	●	○	16	16	125	16.3	17				
ADKT-ZCC2-R/L-1616-3-T20	●	○	16	16	125	16.3	20				
ADKT-ZCC2-R/L-2020-3-T12	●	●	20	20	125	20.3	12	Z.GD - 4	2004-M8x1x20	-	AAL-05-4
ADKT-ZCC2-R/L-2020-3-T20	●	●	20	20	125	20.3	20				
ADKT-ZCC2-R/L-2020-3-R21	●	○	20	20	125	20.3	21				
ADKT-ZCC2-R/L-2020-3-R25	●	●	20	20	125	20.3	25	Z.HD - 5	2004-M8x1x20	-	AAL-05-4
ADKT-ZCC2-R/L-2525-3-T12	●	○	25	25	150	25.3	12				
ADKT-ZCC2-R/L-2525-3-T22	●	●	25	25	150	25.3	22				
ADKT-ZCC2-R/L-2525-3-R30	●	●	25	25	150	25.3	30	Z.KD - 6	2004-M8x1x20	-	AAL-05-4
ADKT-ZCC2-R/L-2020-4-T12	●	○	20	20	125	20.5	12				
ADKT-ZCC2-R/L-2020-4-T20	●	●	20	20	125	20.5	20				
ADKT-ZCC2-R/L-2525-4-T12	●	●	25	25	150	25.5	12	Z.HD - 5	2004-M8x1x20	-	AAL-05-4
ADKT-ZCC2-R/L-2525-4-T22	●	●	25	25	150	25.5	22				
ADKT-ZCC2-R/L-2020-5-T12	●	○	20	20	125	20.5	12				
ADKT-ZCC2-R/L-2020-5-T20	●	●	20	20	125	20.5	20	Z.KD - 6	2004-M8x1x20	-	AAL-05-4
ADKT-ZCC2-R/L-2525-5-T12	●	○	25	25	150	25.5	12				
ADKT-ZCC2-R/L-2525-5-T25	●	●	25	25	150	25.5	25				
ADKT-ZCC2-R/L-3232-5-T25	●	●	32	32	170	32.4	25	Z.KD - 6	2004-M8x1x20	-	AAL-05-4
ADKT-ZCC2-R/L-2020-6-T20	●	●	20	20	125	20.6	20				
ADKT-ZCC2-R/L-2525-6-T25	●	●	25	25	150	25.6	25				
ADKT-ZCC2-R/L-3232-6-T25	●	●	32	32	170	32.6	25	Z.KD - 6	2004-M8x1x20	-	AAL-05-4
ADKT-ZCC2-R/L-3232-6-T30	●	●	32	32	170	32.6	30				

R: Sağ / Right / Правый L: Sol/Left/ Левый

● Stokta / In Stock / В наличии ○ Stokta Yok / Non Stock Item / Нет в наличии

ZCC Ucuna Uygundur. / Compatible with ZCC Insert. / Под пластину ZCC

Sipariş Örneği/Ordering Example/Образец заказа

1 ad./pcs./шт ADKT-ZCC2-R-1616-2-T15

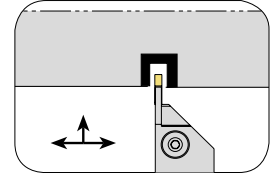
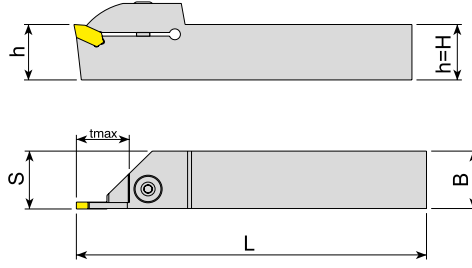

Takım Kodu Ordering Code Код для заказа	Stok Stock Наличие		Takım Ölçüleri (mm) Dimension (mm) Размеры (мм)					Kesici Uç Insert Пластина	Yedek Parçaları / Spare Parts / Запасные части		
	R	L	h=H	B	L	S	t max		Sıkma Vidası Screw Зажимной винт	Pul Stamp Шайба	Anahtar Allen Key Ключ
ADKT-ZCC1-R/L-2020-3-T20	●	○	20	20	125	20.3	20	ZQMX - 3	2004-M8x1x20	-	AAL-05-4
ADKT-ZCC1-R/L-2525-3-T22	●	○	25	25	150	25.3	22				
ADKT-ZCC1-R/L-2020-4-T20	●	○	20	20	125	20.4	20	ZQMX - 4	2004-M8x1x20	-	AAL-05-4
ADKT-ZCC1-R/L-2525-4-T22	●	○	25	25	150	25.4	22				

ZCC Ucuna Uygundur. / Compatible with ZCC Insert. / Под пластину ZCC

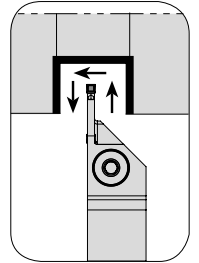
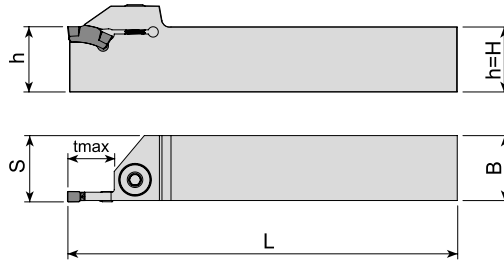

Takım Kodu Ordering Code Код для заказа	Stok Stock Наличие		Takım Ölçüleri (mm) Dimension (mm) Размеры (мм)					Kesici Uç Insert Пластина	Yedek Parçaları / Spare Parts / Запасные части		
	R	L	h=H	B	L	S	t max		Sıkma Vidası Screw Зажимной винт	Pul Stamp Шайба	Anahtar Allen Key Ключ
ADKT-ITG-R/L-2020-3-T8	●	●	20	20	125	20.3	8	TGM. - 3	2004-M8x1x20	-	AAL-05-4
ADKT-ITG-R/L-2525-3-T8	●	●	25	25	150	25.3	8				
ADKT-ITG-R/L-3232-3-T8	●	○	32	32	170	32.3	8				
ADKT-ITG-R/L-2020-4-T9	●	●	20	20	125	20.4	9	TGM. - 4	2004-M8x1x20	-	AAL-05-4
ADKT-ITG-R/L-2525-4-T17	●	●	25	25	150	25.4	17				
ADKT-ITG-R/L-3232-4-T17	●	●	32	32	170	32.4	17				
ADKT-ITG-R/L-3232-5-T25	●	○	32	32	170	32.5	25	TGM. - 5	2004-M8x1x20	-	AAL-05-4

R: Sağ / Right / Правый L: Sol/Left/Левый

● Stokta / In Stock / В наличии ○ Stokta Yok / Non Stock Item / Нет в наличии

ISCR Ucuna Uygundur. / Compatible with ISCR Insert. / Под пластину ISCR

Sipariş Örneği/Ordering Example/Образец заказа

1 ad./pcs./шт ADKT-ZCC1-R-2020-3-T20

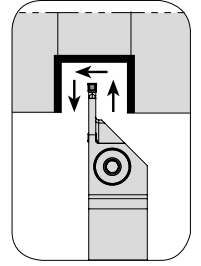
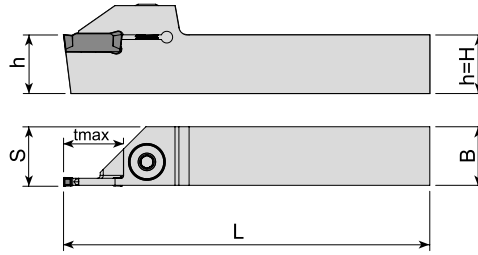

Takım Kodu Ordering Code Код для заказа	Stok Stock Наличие		Takım Ölçüleri (mm) Dimension (mm) Размеры (мм)					Kesici Uç Insert Пластина	Yedek Parçaları / Spare Parts / Запасные части		
	R	L	h=H	B	L	S	t max		Sıkma Vidası Screw Зажимной винт	Pul Stamp Шайба	Anahtar Allen Key Ключ
ADKT-I-R/L-1212-2-T15	●	●	12	12	125	16.3	15	DGN - 2	AKV-02-M6x22	ABPL-01	AAL-03-3
ADKT-I-R/L-1616-2-T15	●	●	16	16	100	16.3	15				
ADKT-I-R/L-2020-2-T15	●	●	20	20	125	20.3	15				
ADKT-I-R/L-2525-2-T15	●	●	25	25	150	25.3	15				
ADKT-I-R/L-3232-2-T15	●	●	32	32	170	32.3	15				
ADKT-I-R/L-1212-3-T15	●	●	12	12	100	16.3	15	DGN - 3			
ADKT-I-R/L-1616-3-T15	●	●	16	16	125	16.4	15				
ADKT-I-R/L-2020-3-T20	●	●	20	20	125	20.4	20				
ADKT-I-R/L-2525-3-T22	●	●	25	25	150	25.4	22				
ADKT-I-R/L-3232-3-T22	●	●	32	32	170	32.4	22				
ADKT-I-R/L-2020-4-T20	●	●	20	20	125	20.4	20	DGN / GRP - 4	2004-M8x1x20	-	AAL-05-4
ADKT-I-R/L-2525-4-T22	●	●	25	25	150	25.4	22				
ADKT-I-R/L-3232-4-T25	●	●	32	32	170	32.4	25	DGN / GRP - 5			
ADKT-I-R/L-2020-5-T20	●	●	20	20	125	20.5	20				
ADKT-I-R/L-2525-5-T25	●	●	25	25	150	25.5	25				
ADKT-IG-R/L-1616-3-T18	●	○	16	16	125	16.3	18	GRP - 3			
ADKT-IG-R/L-2020-3-R20	●	●	20	20	125	20.4	20				
ADKT-IG-R/L-2525-3-T22	●	●	25	25	150	25.4	22				
ADKT-IGI-R/L-2020-2-T15	●	●	20	20	125	20.3	15	GIM / GIP - 2	AKV-02-M6x22	ABPL-01	AAL-03-3
ADKT-IGI-R/L-2525-2-T15	●	●	25	25	150	25.4	15				
ADKT-IGI-R/L-1616-3-T15	●	●	16	16	125	16.4	15	GIM / GIP - 3			
ADKT-IGI-R/L-2020-3-T20	●	●	20	20	125	20.4	20				
ADKT-IGI-R/L-2525-3-T22	●	●	25	25	150	25.4	22				
ADKT-IGI-R/L-2525-4-T22	●	●	25	25	150	25.5	22	GIM / GIP - 4	2004-M8x1x20	-	AAL-05-4
ADKT-IGI-R/L-2525-5-T25	●	●	25	25	150	25.6	25				
ADKT-IGI-R/L-2525-8-T30	●	○	25	25	150	25.8	30	GIM / GIP - 8			
ADKT-IGTN-R/L-2525-5-T25	●	●	25	25	150	25.6	25	GTN - 5			
ADKT-IDC-R/L-2525-3-T21	●	○	25	25	150	25.4	21	DCE - 3			

R: Sağ / Right / Правый L: Sol/Left/Левый

● Stokta / In Stock / В наличии ○ Stokta Yok / Non Stock Item / Нет в наличии

ISCR Ucuna Uygunudur. / Compatible with ISCR Insert. / Под пластину ISCR

Sipariş Örneği/Ordering Example/Образец заказа

1 ad./pcs./шт ADKT-I-R-1212-2-T15

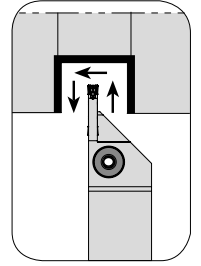
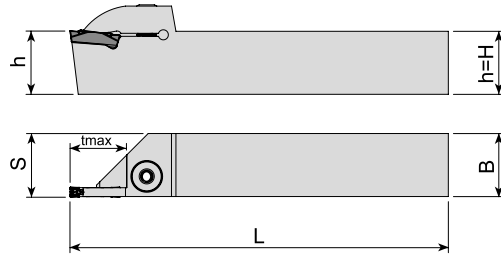

Takım Kodu Ordering Code Код для заказа	Stok Stock Наличие		Takım Ölçüleri (mm) Dimension (mm) Размеры (мм)				Kesici Uç Insert Пластина	Yedek Parçaları / Spare Parts / Запасные части			
	R	L	h=H	B	L	S		t _{max}	Sıkma Vidası Screw Зажимной винт	Pul Stamp Шайба	Anahtar Allen Key Ключ
ADKT-KM-R/L-2020-2-T15	●	●	20	20	125	20.3	15	A4. - 2	AKV-02-M6x22	ABPL-01	AAL-03-3
ADKT-KM-R/L-2525-2-T15	●	●	25	25	150	25.3	15				
ADKT-KM-R/L-2020-3-T20	●	●	20	20	125	20.4	20	A4. - 3	2004-M8x1x20	-	AAL-05-4
ADKT-KM-R/L-2525-3-T22	●	●	25	25	150	25.4	22				
ADKT-KM-R/L-2525-4-T22	●	●	25	25	150	25.5	22	A4. - 4			

KNMNTL Ucuna Uygundur. / Compatible with KNMNTL Insert. / Под пластину KNMNTL

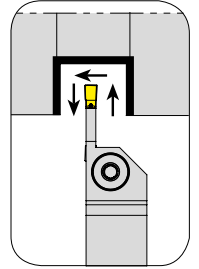
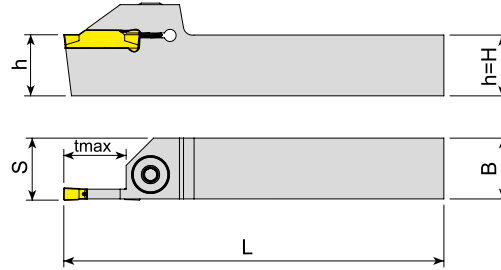

Takım Kodu Ordering Code Код для заказа	Stok Stock Наличие		Takım Ölçüleri (mm) Dimension (mm) Размеры (мм)				Kesici Uç Insert Пластина	Yedek Parçaları / Spare Parts / Запасные части			
	R	L	h=H	B	L	S		t _{max}	Sıkma Vidası Screw Зажимной винт	Pul Stamp Шайба	Anahtar Allen Key Ключ
ADKT-123-R/L-1212-1.5-R15	●	●	12	12	100	16.2	15	123 - 1.5	AKV-02-M6x22	ABPL-01	AAL-03-3
ADKT-123-R/L-1616-1.5-R15	●	●	16	16	125	16.3	15				
ADKT-123-R/L-1616-2-T15	●	○	16	16	125	16.3	15	123 - 2	AKV-02-M6x22	ABPL-01	AAL-03-3
ADKT-123-R/L-2020-2-T8	●	○	20	20	125	20.2	8				
ADKT-123-R/L-2020-2-T15	●	●	20	20	125	20.3	15	123 - 3	2004-M8x1x20	-	AAL-05-4
ADKT-123-R/L-2525-2-T15	●	●	25	25	150	25.3	15				
ADKT-123-R/L-3232-2-T15	●	●	32	32	170	32.3	15	123 - 4	2004-M8x1x20	-	AAL-05-4
ADKT-123-R/L-1616-3-T15	●	●	16	16	125	16.4	15				
ADKT-123-R/L-2020-3-T20	●	●	20	20	125	20.4	20	123 - 5	2004-M8x1x20	-	AAL-05-4
ADKT-123-R/L-2525-3-T22	●	●	25	25	150	25.4	22				
ADKT-123-R/L-2020-4-T20	●	●	20	20	125	20.4	20	123 - 6	2004-M8x1x20	-	AAL-05-4
ADKT-123-R/L-2525-4-T22	●	●	25	25	150	25.4	22				
ADKT-123-R/L-3232-4-T25	●	●	32	32	170	32.4	25	123 - 5	2004-M8x1x20	-	AAL-05-4
ADKT-123-R/L-2020-5-T20	●	●	20	20	125	20.5	20				
ADKT-123-R/L-2525-5-T25	●	●	25	25	150	25.5	25	123 - 6	2004-M8x1x20	-	AAL-05-4
ADKT-123-R/L-3232-6-T15	●	○	32	32	170	32.5	15				

R: Sağ / Right / Правый L: Sol/Left/Левый

● Stokta / In Stock / В наличии ○ Stokta Yok / Non Stock Item / Нет в наличии

SNDVK Ucuna Uygundur. / Compatible with SNDVK Insert. / Под пластину SNDVK

Sipariş Örneği/Ordering Example/Образец заказа

1 ad./pcs./шт ADKT-KM-R-2020-2-T15

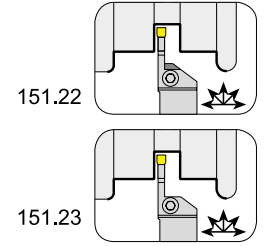
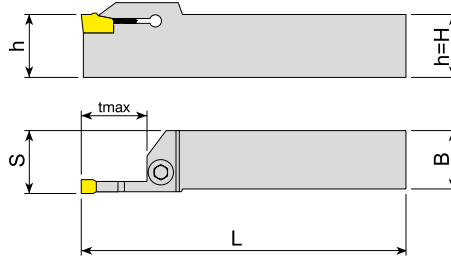

Takım Kodu Ordering Code Код для заказа	Stok Stock Наличие		Takım Ölçüleri (mm) Dimension (mm) Размеры (мм)					Kesici Uç Insert Пластина	Yedek Parçaları / Spare Parts / Запасные части						
	R	L	h=H	B	L	S	t _{max}		Sıkma Vidası Screw Зажимной винт	Pul Stamp Шайба	Anahtar Allen Key Ключ				
ADKT-151.22-R/L-1616-2-T15	●	●	16	16	125	16.3	15								
ADKT-151.22-R/L-2020-2-T15	●	●	20	20	125	20.3	15					151.2 - 2	AKV-02-M6x22	ABPL-01	AAL-03-3
ADKT-151.22-R/L-2525-2-T15	●	●	25	25	150	25.3	15								
ADKT-151.22-R/L-1616-3-T15	●	●	16	16	125	16.4	15	151.2 - 3							
ADKT-151.22-R/L-2020-3-T20	●	●	20	20	125	20.4	20								
ADKT-151.22-R/L-2525-3-T22	●	●	25	25	150	25.4	22								
ADKT-151.22-R/L-1616-4-T15	●	●	16	16	125	16.4	15	151.2 - 4	2004-M8x1x20	-	AAL-05-4				
ADKT-151.22-R/L-2020-4-T20	●	●	20	20	125	20.4	20								
ADKT-151.22-R/L-2525-4-T22	●	●	25	25	150	25.4	22								
ADKT-151.22-R/L-2020-5-T20	●	●	20	20	125	20.5	20	151.2 - 5							
ADKT-151.22-R/L-2525-5-T25	●	●	25	25	150	25.5	25								
ADKT-151.23-R/L-1616-2-T15	●	●	16	16	125	16.3	15	151.2 - 2	AKV-02-M6x22	ABPL-01	AAL-03-3				
ADKT-151.23-R/L-2020-2-T15	●	●	20	20	125	20.3	15								
ADKT-151.23-R/L-2525-2-T15	●	●	25	25	150	25.3	15								
ADKT-151.23-R/L-1616-2.5-T15	●	●	16	16	125	16.3	15	151.2 - 2.5							
ADKT-151.23-R/L-2020-2.5-T15	●	●	20	20	125	20.3	15								
ADKT-151.23-R/L-2525-2.5-T15	●	●	25	25	150	25.3	15								
ADKT-151.23-R/L-1212-3-T15	●	●	12	12	100	16.4	15	151.2 - 3	2004-M8x1x20	-	AAL-05-4				
ADKT-151.23-R/L-1616-3-T15	●	●	16	16	125	16.4	15								
ADKT-151.23-R/L-2020-3-T20	●	●	20	20	125	20.4	20								
ADKT-151.23-R/L-2525-3-T20	●	●	25	25	150	25.4	20	151.2 - 4							
ADKT-151.23-R/L-2525-3-T22	●	●	25	25	150	25.4	22								
ADKT-151.23-R/L-1616-4-T15	●	●	16	16	125	16.4	15								
ADKT-151.23-R/L-2020-4-T20	●	●	20	20	125	20.4	20	151.2 - 5							
ADKT-151.23-R/L-2525-4-T22	●	●	25	25	150	25.4	22								
ADKT-151.23-R/L-2020-5-T20	●	●	20	20	125	20.5	20								
ADKT-151.23-R/L-2525-5-T25	●	●	25	25	150	25.5	25								

R: Sağ / Right / Правый L: Sol/Left/Левый

● Stokta / In Stock / В наличии ○ Stokta Yok / Non Stock Item / Нет в наличии

SNDVK Ucuna Uygunudur. / Compatiple with SNDVK Insert. / Под пластину SNDVK

Sipariş Örneği/Ordering Example/Образец заказа

1 ad./pcs./шт ADKT-151.22-R-1616-2-T15

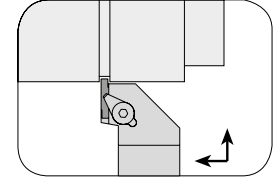
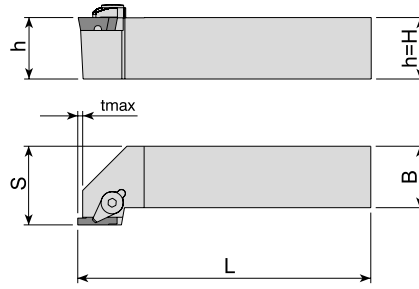

Takım Kodu Ordering Code Код для заказа	Stok Stock Наличие	Takım Ölçüleri (mm) Dimension (mm) Размеры (мм)						Kesici Uç Insert Пластина	Yedek Parçaları / Spare Parts / Запасные части				
		R	L	h=H	B	L	S		t max	Baskı Parçası Wedge Clamp Прижим	Sıkma Vidası Screw Зажимной винт	Pim Pin Штифт	Anahtar Allen Key Ключ
ADKT-154.91-R/L-2020-3-T4	●●	20	20	125	25	4	154.91 - 3		ACK-03	AKV-07-M6x22	APM-06	AAL-03-3	
ADKT-154.91-R/L 2525-3-T4	●●	25	25	150	30.5	4							
ADKT-154.91-R/L 2020-5-T5	●●	20	20	125	25	5	154.91 - 5		ACK-03	AKV-07-M6x22	APM-06	AAL-03-3	
ADKT-154.91-R/L 2525-5-T5	●●	25	25	150	30.5	5							

SNDVK Ucuna Uygun. / Compatible with SNDVK Insert. / Под пластину SNDVK

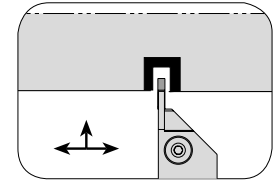
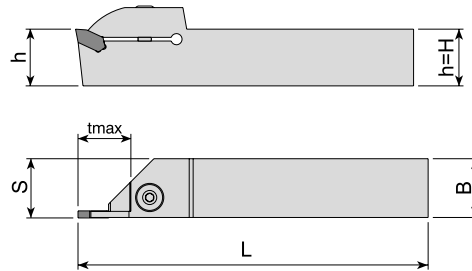

Takım Kodu Ordering Code Код для заказа	Stok Stock Наличие	Takım Ölçüleri (mm) Dimension (mm) Размеры (мм)						Kesici Uç Insert Пластина	Yedek Parçaları / Spare Parts / Запасные части			
		R	L	h=H	B	L	S		t max	Sıkma Vidası Screw Зажимной винт	Pul Stamp Шайба	Anahtar Allen Key Ключ
ADKT-ARN-R/L-2020-2-T15	●●	20	20	125	20.3	15	LOMR. - 2		AKV-02-M6x22	ABPL-01	AAL-03-3	
ADKT-ARN-R/L-2525-2-T15	●●	25	25	150	25.3	15						
ADKT-ARN-R/L-2020-3-T20	●●	20	20	125	20.4	20	LOMR. - 3		2004-M8x1x20	-	AAL-05-4	
ADKT-ARN-R/L-2525-3-T22	●●	25	25	150	25.4	22						

R: Sağ / Right / Правый L: Sol/Left/Левый

● Stokta / In Stock / В наличии ○ Stokta Yok / Non Stock Item / Нет в наличии

ARN Ucuna Uygun. / Compatible with ARN Insert. / Под пластину ARN

Sipariş Örneği/Ordering Example/Образец заказа

1 ad./pcs./шт ADKT-154.91-R-2020-3-T4

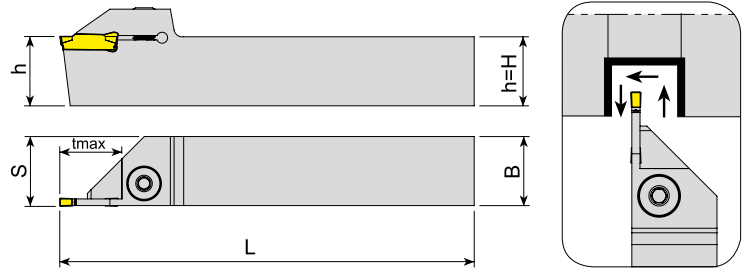

Takım Kodu Ordering Code Код для заказа	Stok Stock Наличие		Takım Ölçüleri (mm) Dimension (mm) Размеры (мм)					Kesici Uç Insert Пластина	Yedek Parçaları / Spare Parts / Запасные части		
	R	L	h=H	B	L	S	t _{max}		Sıkma Vidası Screw Зажимной винт	Pul Stamp Шайба	Anahtar Allen Key Ключ
ADKT-TD-R/L-1212-2-T15	●	●	12	12	100	12.3	15	TD. - 2	AKV-02-M6x22	ABPL-01	AAL-03-3
ADKT-TD-R/L-1616-2-T15	●	●	16	16	125	16.3	15				
ADKT-TD-R/L-2020-2-T9	●	○	20	20	125	20.3	9				
ADKT-TD-R/L-2020-2-T15	●	●	20	20	125	20.3	15				
ADKT-TD-R/L-2020-2-T20	●	○	20	20	125	20.3	20				
ADKT-TD-R/L-2525-2-T17	●	●	25	25	150	25.3	17				
ADKT-TD-R/L-1212-3-T15	●	●	12	12	100	12.4	15	TD. - 3	2004-M8x1x20	-	AAL-05-4
ADKT-TD-R/L-1616-3-T15	●	●	16	16	125	16.4	15				
ADKT-TD-R/L-2020-3-T20	●	●	20	20	125	20.4	20				
ADKT-TD-R/L-2020-3-T25	●	○	20	20	125	20.4	25				
ADKT-TD-R/L-2020-3-T30	●	●	20	20	125	20.4	30				
ADKT-TD-R/L-2525-3-T9	●	●	25	25	150	25.4	9				
ADKT-TD-R/L-2525-3-T22	●	●	25	25	150	25.4	22	TD. - 4			
ADKT-TD-R/L-2525-3-T25	●	●	25	25	150	25.4	25				
ADKT-TD-R/L-2525-3-T30	●	○	25	25	150	25.4	30				
ADKT-TD-R/L-3232-3-T25	●	○	32	32	170	32.4	25				
ADKT-TD-R/L-2525-4-T22	●	●	25	25	150	25.5	22				
ADKT-TD-R/L-2525-4-T30	●	○	25	25	150	25.5	30				
ADKT-TD-R/L-2525-5-T25	●	●	25	25	150	25.5	25	TD. - 5			

TGTC Uçuna Uygundur. / Compatible with TGTC Insert. / Под пластину TGTC

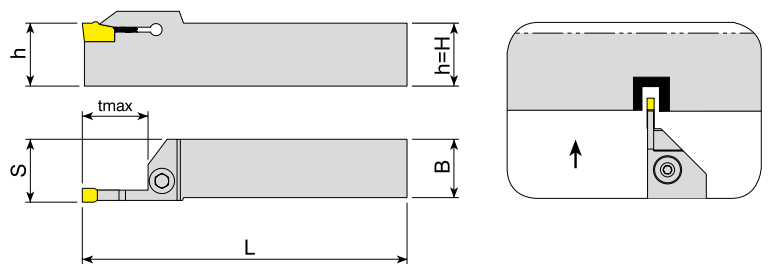

Takım Kodu Ordering Code Код для заказа	Stok Stock Наличие		Takım Ölçüleri (mm) Dimension (mm) Размеры (мм)					Kesici Uç Insert Пластина	Yedek Parçaları / Spare Parts / Запасные части		
	R	L	h=H	B	L	S	t _{max}		Sıkma Vidası Screw Зажимной винт	Pul Stamp Шайба	Anahtar Allen Key Ключ
ADKT-SWC-R/L-2020-2-T25	●	○	20	20	125	20.3	25	WCF. - 2	AKV-02-M6x22	ABPL-01	AAL-03-3
ADKT-SWC-R/L-2020-3-T25	●	○	20	20	125	20.4	25	WCF. - 3	2004-M8x1x20	-	AAL-05-4

R: Sağ / Right / Правый L: Sol/Left/Левый
● Stokta / In Stock / В наличии ○ Stokta Yok / Non Stock Item / Нет в наличии
SMTM Uçuna Uygundur. / Compatible with SMTM Insert. / Под пластину SMTM

Sipariş Örneği/Ordering Example/Образец заказа
1 ad./pcs./шт ADKT-TD-R-1212-2-T15

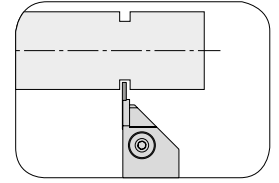
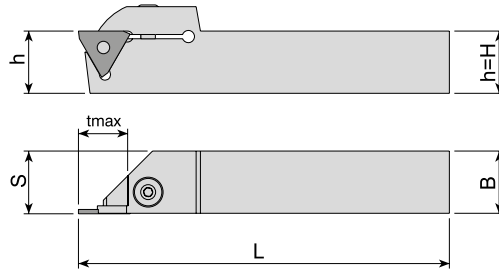

Takım Kodu Ordering Code Код для заказа	Stok Stock Наличие		Takım Ölçüleri (mm) Dimension (mm) Размеры (мм)					Kesici Uç Insert Пластина	Yedek Parçaları / Spare Parts / Запасные части				
	R	L	h=H	B	L	S	t _{max}		Sıkma Vidası Screw Зажимной винт	Baskı Pabucu Wedge Clamp Прижим	Sekman Ring Кольцо	Anahtar Allen Key Ключ	
ADKT-H22-R/L-1616-(0.5-2)-T4	●	●	16	16	125	16.2	4	S312 - (0.5-2)	AKV-29-M6x29	AKK-04	AS-01	AAL-03-3	
ADKT-H22-R/L-2020-(0.5-2)-T4	●	●	20	20	125	20.2	4						
ADKT-H22-R/L-2525-(0.5-2)-T4	●	●	25	25	150	25.2	4						

HRN Ucuna Uygundur. / Compatible with HRN Insert. / Под пластину HRN

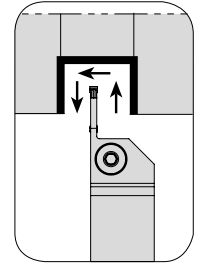
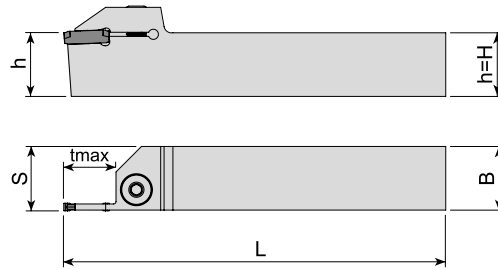

Takım Kodu Ordering Code Код для заказа	Stok Stock Наличие		Takım Ölçüleri (mm) Dimension (mm) Размеры (мм)					Kesici Uç Insert Пластина	Yedek Parçaları / Spare Parts / Запасные части			
	R	L	h=H	B	L	S	t _{max}		Sıkma Vidası Screw Зажимной винт	Pul Stamp Шайба	Anahtar Allen Key Ключ	
ADKT-LGC-R/L-1616-2-D40	●	●	16	16	125	16.2	20	GCTX - 2	AKV-02-M6x22	ABPL-01	AAL-03-3	
ADKT-LGC-R/L-2020-2-D40	●	●	20	20	125	20.2	20					
ADKT-LGC-R/L-2525-2-D40	●	●	25	25	150	25.2	20					
ADKT-LGC-R/L-1616-3-T20	●	●	16	16	125	16.3	20	GCTX - 3	2004-M8x1x20	-	AAL-05-4	
ADKT-LGC-R/L-2020-3-T20	●	●	20	20	125	20.3	20					
ADKT-LGC-R/L-2525-3-T20	●	●	25	25	150	25.3	20					

R: Sağ / Right / Правый L: Sol/Left/Левый

● Stokta / In Stock / В наличии ○ Stokta Yok / Non Stock Item / Нет в наличии

LMN Ucuna Uygundur. / Compatible with LMN Insert. / Под пластину LMN

Sipariş Örneği/Ordering Example/Образец заказа

1 ad./pcs./шт ADKT-H22-R-1616-(0.5-2)T16

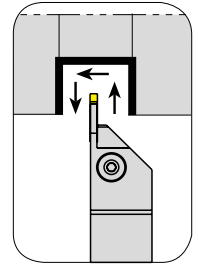
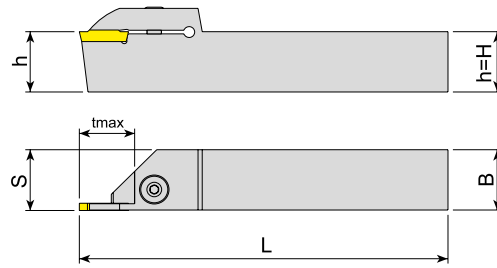

Takım Kodu Ordering Code Код для заказа	Stok Stock Наличие		Takım Ölçüleri (mm) Dimension (mm) Размеры (мм)					Kesici Uç Insert Пластина	Yedek Parçaları / Spare Parts / Запасные части		
	R	L	h=H	B	L	S	t max		Sıkma Vidası Screw Зажимной винт	Pul Stamp Шайба	Anahtar Allen Key Ключ
ADKT-WGX16-R/L-2020-2-R16	●	○	20	20	125	20.3	16	GX16. - 2	AKV-02-M6x22	ABPL-01	AAL-03-3
ADKT-WGX16-R/L-2525-2-R16	●	○	25	25	150	20.3	16				
ADKT-WGX24-R/L-2020-3-T20	●	●	20	20	125	20.3	20	GX24. - 3	2004-M8x1x20	-	AAL-05-4
ADKT-WGX24-R/L-2525-3-T22	●	●	25	25	150	25.3	22				
ADKT-WGX24-R/L-3232-3-T22	●	○	32	32	170	32.3	22				
ADKT-WGX24-R/L-2525-4-T22	●	●	25	25	150	25.4	22	GX24. - 4			
ADKT-WGX24-R/L-2525-5-T25	●	●	25	25	150	25.5	25	GX24. - 5			
ADKT-WGX24-R/L-3232-5-T25	●	●	32	32	170	32.5	25				

WLTR Ucuna Uygunudur. / Compatible with WLTR Insert. / Под пластину WLTR

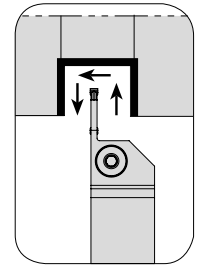
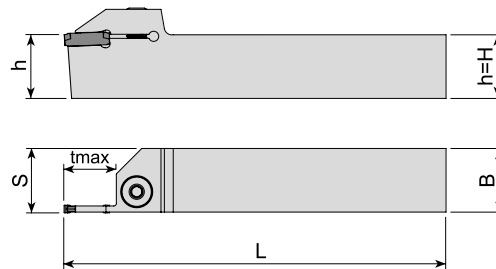

Takım Kodu Ordering Code Код для заказа	Stok Stock Наличие		Takım Ölçüleri (mm) Dimension (mm) Размеры (мм)					Kesici Uç Insert Пластина	Yedek Parçaları / Spare Parts / Запасные части		
	R	L	h=H	B	L	S	t max		Sıkma Vidası Screw Зажимной винт	Pul Stamp Шайба	Anahtar Allen Key Ключ
ADKT-GP-R/L-2020-3-T20	●	●	20	20	125	20.3	20	GP - 3			
ADKT-GP-R/L-2525-3-T22	●	●	25	25	150	25.3	22				
ADKT-GP-R/L-2525-4-T22	●	●	25	25	150	25.4	22	GP - 4	2004-M8x1x20	-	AAL-05-4
ADKT-GP-R/L-2525-5-T25	●	●	25	25	150	25.5	25	GP - 5			

R: Sağ / Right / Правый L: Sol/Left/Левый

● Stokta / In Stock / В наличии ○ Stokta Yok / Non Stock Item / Нет в наличии

PLBT Ucuna Uygunudur. / Compatible with PLBT Insert. / Под пластину PLBT

Sipariş Örneği/Ordering Example/Образец заказа

1 ad./pcs./шт ADKT-WGX24-R-2525-3-T22

DIŞ ÇAP KANAL AÇMA TAKIMLARI
EXTERNAL GROOVING TOOLHOLDERS
ДЕРЖАВКИ ДЛЯ ОБРАБОТКИ НАРУЖНЫХ КАНАВOK

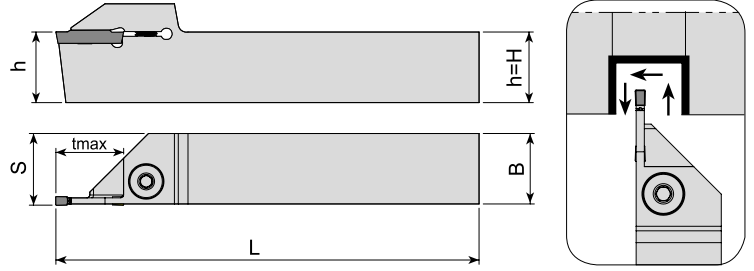

Takım Kodu Ordering Code Код для заказа	Stok Stock Наличие		Takım Ölçüleri (mm) Dimension (mm) Размеры (мм)					Kesici Uç Insert Пластина	Yedek Parçaları / Spare Parts / Запасные части		
	R	L	h=H	B	L	S	t max		Sıkma Vidası Screw Зажимной винт	Pul Stamp Шайба	Anahtar Allen Key Ключ
ADKT-CD-R/L-2020-3-R20	●	○	20	20	125	20.3	20	GX24 0300	2004-M8x1x20	-	AAL-05-4
ADKT-CD-R/L-2525-3-R23	●	○	25	25	150	25.3	23				

CRTZT Ucuna Uygun. / Compatible with CRTZT Insert. / Под пластину CRTZT

DIŞ ÇAP KANAL AÇMA İSVİÇRE TİPİ KAYAR OTOMAT MAKİNA TAKIMLARI
EXTERNAL GROOVING TOOLHOLDERS FOR SWISS TYPE SLIDING AUTOMATIC LATHES
ДЕРЖАВКИ ДЛЯ ОБРАБОТКИ НАРУЖНЫХ КАНАВOK ДЛЯ ТОКАРНЫХ СТАНКОВ ШВЕЙЦАРСКОГО ТИПА

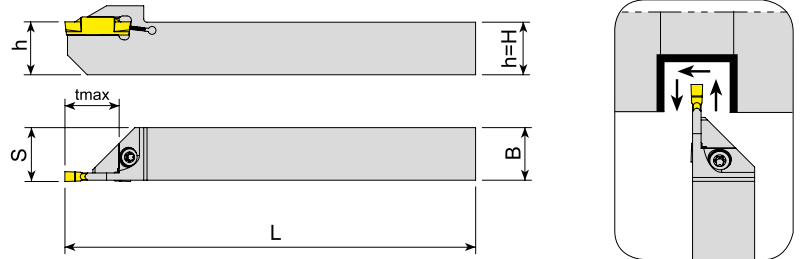

Takım Kodu Ordering Code Код для заказа	Stok Stock Наличие		Takım Ölçüleri (mm) Dimension (mm) Размеры (мм)					Kesici Uç Insert Пластина	Yedek Parçaları / Spare Parts / Запасные части		
	R	L	h=H	B	L	S	t max		Sıkma Vidası Screw Зажимной винт	Pul Stamp Шайба	Tork Anahtar Torx Key Torx Ключ
ADKT-TD-R/L-1212-2-T12-K-S	●	●	12	12	125	12.2	12	TD. - 2	4015-M4x11	-	80-T15
ADKT-TD-R/L-1616-2-T16-K-S	●	●	16	16	125	16.2	16				
ADKT-TD-R/L-1212-3-T12-K-S	●	●	12	12	125	12.3	12	TD. - 3	-	-	-
ADKT-TD-R/L-1616-3-T16-K-S	●	●	16	16	125	16.3	16				

R: Sağ / Right / Правый L: Sol/Left/Левый
● Stokta / In Stock / В наличии ○ Stokta Yok / Non Stock Item / Нет в наличии
TGTC Ucuna Uygun. / Compatible with TGTC Insert. / Под пластину TGTC

Sipariş Örneği/Ordering Example/Образец заказа
1 ad./pcs./шт ADKT-CD-R-2020-3-R20

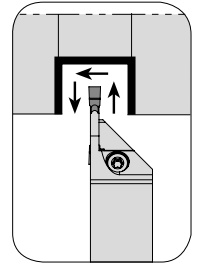
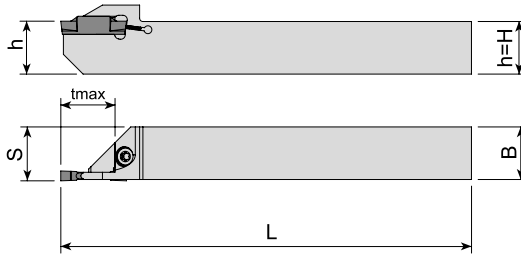

Takım Kodu Ordering Code Код для заказа	Stok Stock Наличие		Takım Ölçüleri (mm) Dimension (mm) Размеры (мм)					Kesici Uç Insert Пластина	Yedek Parçaları / Spare Parts / Запасные части		
	R	L	h=H	B	L	S	t max		Sıkma Vidası Screw Зажимной винт	Pul Stamp Шайба	Tork Anahtar Torx Key Торх Ключ
ADKT-ZCC2-R/L-1010-2-T12-K-S	●	●	10	10	125	10.2	12	Z.BD - 2	4015-M4x11	-	80-T15
ADKT-ZCC2-R/L-1212-2-T12-K-S	●	●	12	12	125	12.2	12				
ADKT-ZCC2-R/L-1616-2-R16-K-S	●	●	16	16	125	16.2	16	Z.FD - 3			
ADKT-ZCC2-R/L-1212-3-T12-K-S	●	●	12	12	125	12.3	12				

ZCC Ucuna Uygundur. / Compatible with ZCC Insert. / Под пластину ZCC

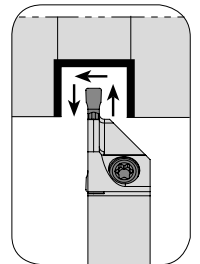
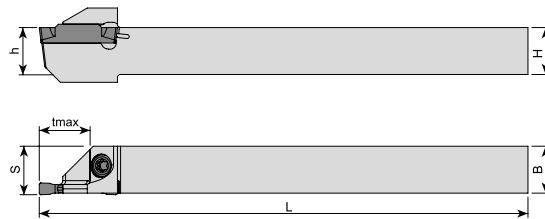

Takım Kodu Ordering Code Код для заказа	Stok Stock Наличие		Takım Ölçüleri (mm) Dimension (mm) Размеры (мм)					Kesici Uç Insert Пластина	Yedek Parçaları / Spare Parts / Запасные части		
	R	L	h=H	B	L	S	t max		Sıkma Vidası Screw Зажимной винт	Pul Stamp Шайба	Tork Anahtar Torx Key Торх Ключ
ADKT-KG-R/L-1212-2-R12-K-S	●	●	12	12	125	12.2	12	KG. - 2	4015-M4x11	-	80-T15
ADKT-KG-R/L-1616-2-R16-K-S	●	●	16	16	125	16.2	16				
ADKT-KG-R/L-1212-3-R12-K-S	●	●	12	12	125	12.3	12	KG. - 3			
ADKT-KG-R/L-1616-3-R16-K-S	●	●	16	16	125	16.3	16				

R: Sağ / Right / Правый L: Sol/Left/Левый
 ● Stokta / In Stock / В наличии ○ Stokta Yok / Non Stock Item / Нет в наличии
 KRLY Ucuna Uygundur. / Compatible with KRLY Insert. / Под пластину KRLY

Sipariş Örneği/Ordering Example/Образец заказа
 1 ad./pcs./шт ADKT-ZCC2-R-1010-2-T12-K-S

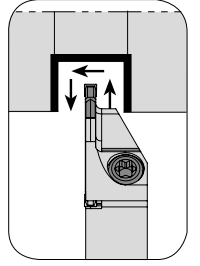
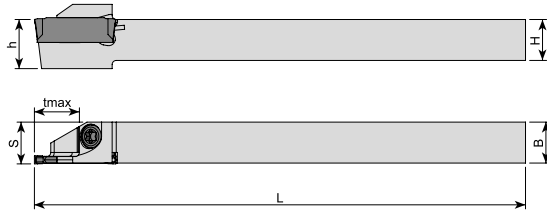

Takım Kodu Ordering Code Код для заказа	Stok Stock Наличие		Takım Ölçüleri (mm) Dimension (mm) Размеры (мм)					Kesici Uç Insert Пластина	Yedek Parçaları / Spare Parts / Запасные части		
	R	L	h=H	B	L	S	t max		Sıkma Vidası Screw Зажимной винт	Pul Stamp Шайба	Tork Anahtar Torx Key Torx Ключ
ADKT-I-R/L-0808-2-R10-S	●	●	08	08	100	8.2	10	DGN - 2	4015-M4x11	-	80-T15
ADKT-I-R/L-1010-2-R10-K-S	●	●	10	10	120	10.2	10				
ADKT-I-R/L-1212-2-R12-K-S	●	●	12	12	125	12.2	12	DGN - 3	4015-M4x11	-	80-T15
ADKT-I-R/L-1616-3-R16-K-S	●	●	16	16	120	16.3	16				

ISCR Ucuna Uygundur. / Compatible with ISCR Insert. / Под пластину ISCR

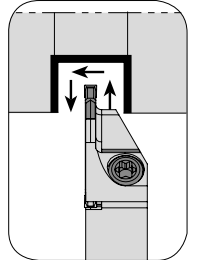
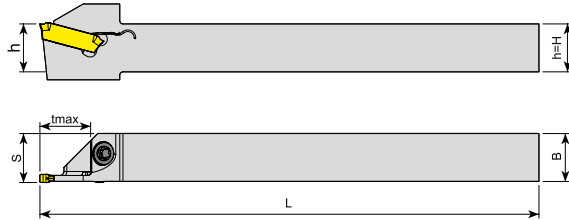

Takım Kodu Ordering Code Код для заказа	Stok Stock Наличие		Takım Ölçüleri (mm) Dimension (mm) Размеры (мм)					Kesici Uç Insert Пластина	Yedek Parçaları / Spare Parts / Запасные части		
	R	L	h=H	B	L	S	t max		Sıkma Vidası Screw Зажимной винт	Pul Stamp Шайба	Tork Anahtar Torx Key Torx Ключ
ADKT-WGX16-R/L-1212-2-R12-K-S	●	●	12	12	125	12.2	16	GX16-2	4015-M4x11	-	80-T15
ADKT-WGX16-R/L-1616-2-R16-K-S	●	○	16	16	125	16.2	16				
ADKT-WGX24-R/L-1616-3-R16-K-S	●	○	16	16	125	16.3	16	GX24-3	4015-M4x11	-	80-T15

R: Sağ / Right / Правый L: Sol/Left/Левый
 ● Stokta / In Stock / В наличии ○ Stokta Yok / Non Stock Item / Нет в наличии
 WLTR Ucuna Uygundur. / Compatible with WLTR Insert. / Под пластину WLTR

Sipariş Örneği/Ordering Example/Образец заказа
 1 ad./pcs./шт ADKT-I-R-0808-2-R10-S

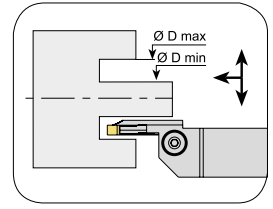
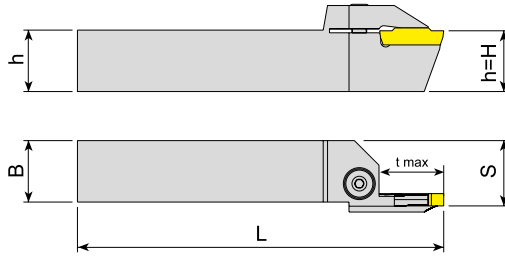

Takım Kodu Ordering Code Код для заказа	Stok Stock Наличие		Takım Ölçüleri (mm) Dimension (mm) Размеры (мм)							Kesici Uç Insert Пластина	Yedek Parçaları / Spare Parts / Запасные части			
	R	L	h=H	B	L	S	t max	Ø D min	Ø D max		Sıkma Vidası Screw Зажимной винт	Pul Stamp Шайба	Anahtar Allen Key Ключ	
AAKT-KG-R/L-2525-44-70-4-T22	○	○	25	25	150	26.5	22	44	70	KG.. - 4	2004-M8x1x20	-	AAL-05-4	
AAKT-KG-R/L-2525-60-120-4-T22	○	○	25	25	150	26.5	22	60	120					
AAKT-KG-R/L-2525-112-200-4-T22	○	○	25	25	150	26.5	22	112	200					

KRLY Ucuna Uygun. / Compatible with KRLY Insert. / Под пластину KRLY

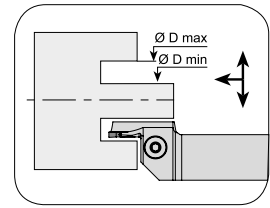
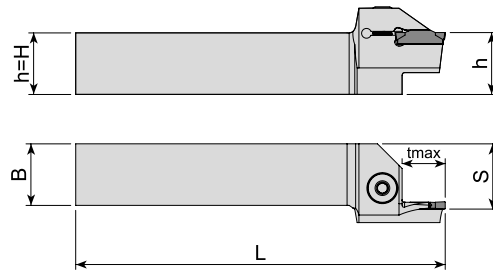

Takım Kodu Ordering Code Код для заказа	Stok Stock Наличие		Takım Ölçüleri (mm) Dimension (mm) Размеры (мм)							Kesici Uç Insert Пластина	Yedek Parçaları / Spare Parts / Запасные части			
	R	L	h=H	B	L	S	t max	Ø D min	Ø D max		Sıkma Vidası Screw Зажимной винт	Pul Stamp Шайба	Anahtar Allen Key Ключ	
AAKT-ZCC2-R/L-2525-140-180-2-T4	●	○	25	25	150	26.5	4	140	180	Z.BD - 2	2004-M8x1x20	-	AAL-05-4	
AAKT-ZCC2-R/L-2525-35-45-3-T17	●	●	25	25	150	26.5	17	35	45					
AAKT-ZCC2-R/L-2525-39-55-3-T17	●	○	25	25	150	26.5	17	39	55					
AAKT-ZCC2-R/L-2525-49-80-3-T17	●	●	25	25	150	26.5	17	49	80	Z.FD - 3	2004-M8x1x20	-	AAL-05-4	
AAKT-ZCC2-R/L-2525-70-110-3-T17	●	●	25	25	150	26.5	17	70	110					
AAKT-ZCC2-R/L-2525-100-150-3-T17	●	●	25	25	150	26.5	17	100	150					
AAKT-ZCC2-R/L-2525-40-60-4-T22	●	○	25	25	150	26.5	22	40	60	Z.GD - 4	2004-M8x1x20	-	AAL-05-4	
AAKT-ZCC2-R/L-2525-52-80-4-T22	●	●	25	25	150	26.5	22	52	80					
AAKT-ZCC2-R/L-2525-72-110-4-T22	●	●	25	25	150	26.5	22	72	110					
AAKT-ZCC2-R/L-2525-100-150-4-T22	●	●	25	25	150	26.5	22	100	150	Z.HD - 5	2004-M8x1x20	-	AAL-05-4	
AAKT-ZCC2-R/L-2525-140-200-4-T22	●	●	25	25	150	26.5	22	140	200					
AAKT-ZCC2-R/L-2525-55-95-5-T25	●	○	25	25	150	26.5	25	55	95					
AAKT-ZCC2-R/L-2525-85-140-5-T25	●	●	25	25	150	26.5	25	85	140	Z.KD - 6	2004-M8x1x20	-	AAL-05-4	
AAKT-ZCC2-R/L-2525-130-200-5-T25	●	○	25	25	150	26.5	25	130	200					
AAKT-ZCC2-R/L-2525-190-400-5-T25	●	●	25	25	150	26.5	25	190	400					
AAKT-ZCC2-R/L-2525-200-500-5-T17	●	●	25	25	150	26.5	25	200	500	Z.KD - 6	2004-M8x1x20	-	AAL-05-4	
AAKT-ZCC2-R/L-2525-60-110-6-T15	●	○	25	25	150	26.5	15	60	110					

R: Sağ / Right / Правый L: Sol/Left/Левый

● Stokta / In Stock / В наличии ○ Stokta Yok / Non Stock Item / Нет в наличии

ZCC Ucuna Uygun. / Compatible with ZCC Insert. / Под пластину ZCC

Sipariş Örneği/Ordering Example/Образец заказа

1 ad./pcs./шт AAKT-KG-R-2525-44-70-4-T22

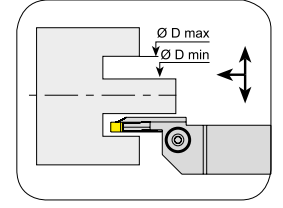
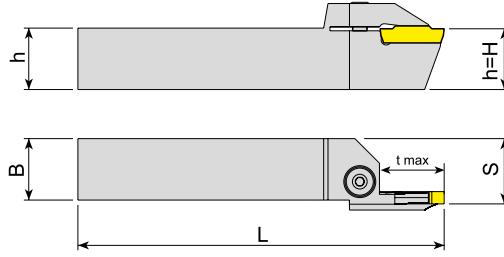

Takım Kodu Ordering Code Код для заказа	Stok Stock Наличие		Takım Ölçüleri (mm) Dimension (mm) Размеры (мм)							Kesici Uç Insert Пластина	Yedek Parçaları / Spare Parts / Запасные части		
	R	L	h=H	B	L	S	t max	Ø D min	Ø D max		Sıkma Vidası Screw Зажимной винт	Pul Stamp Шайба	Anahtar Allen Key Ключ
AAKT-K-R/L-2525-34-45-3-T17	●	●	25	25	150	26.5	17	34	45	MGM. - 3			
AAKT-K-R/L-2525-39-55-3-T17	●	●	25	25	150	26.5	17	39	55				
AAKT-K-R/L-2525-49-80-3-T17	●	●	25	25	150	26.5	17	49	80				
AAKT-K-R/L-2525-70-110-3-T17	●	●	25	25	150	26.5	17	70	110				
AAKT-K-R/L-2525-100-150-3-T17	●	●	25	25	150	26.5	17	100	150				
AAKT-K-R/L-2525-80-180-3-T32	●	●	25	25	150	26.5	32	80	180				
AAKT-K-R/L-2525-175-215-3-T22	●	●	25	25	150	26.5	22	175	215				
AAKT-K-R/L-2525-700-800-3-T17	●	●	25	25	150	26.5	17	700	800				
AAKT-K-R/L-2525-50-85-4-T22	●	●	25	25	150	26.5	22	50	85	MGM. - 4	2004-M8x1x20	-	AAL-05-4
AAKT-K-R/L-2525-70-110-4-T22	●	●	25	25	150	26.5	22	70	110				
AAKT-K-R/L-2525-100-150-4-T22	●	●	25	25	150	26.5	22	100	150				
AAKT-K-R/L-2525-80-180-4-T32	●	●	25	25	150	26.5	32	80	180				
AAKT-K-R/L-2525-180-800-4-T32	●	●	25	25	150	26.5	32	180	800				
AAKT-K-R/L-2525-70-110-5-T25	●	●	25	25	150	26.5	25	70	110	MGM. - 5			
AAKT-K-R/L-2525-100-150-5-T25	●	●	25	25	150	26.5	25	100	150				
AAKT-K-R/L-2525-80-180-5-T32	●	●	25	25	150	26.5	32	80	180				
AAKT-K-R/L-2525-140-200-5-T25	●	●	25	25	150	26.5	25	140	200				
AAKT-K-R/L-2525-180-800-5-T32	●	●	25	25	150	26.5	32	180	800				
AAKT-K-R/L-2525-60-100-6-T25	●	●	25	25	150	26.5	25	60	100	MGM. - 6			
AAKT-K-R/L-2525-60-100-6-T35	●	○	25	25	150	26.5	35	60	100				
AAKT-K-R/L-2525-100-200-6-T25	●	○	25	25	150	26.5	25	100	200				
AAKT-K-R/L-2525-100-200-6-T35	●	○	25	25	150	26.5	35	100	200				
AAKT-K-R/L-2525-100-200-6-T45	●	○	25	25	150	26.5	45	100	200				
AAKT-K-R/L-2525-140-300-6-T35	●	●	25	25	150	26.5	35	140	300				
AAKT-K-R/L-2525-140-300-8-T35	●	○	25	25	150	26.5	35	140	300	MGM. - 8			
AAKT-K-R/L-3232-140-350-8-T35	●	○	32	32	150	33.5	35	140	350				

R: Sağ / Right / Правый L: Sol/Left/Левый
● Stokta / In Stock / В наличии ○ Stokta Yok / Non Stock Item / Нет в наличии
KRLY Ucuna Uygunudur. / Compatible with KRLY Insert. / Под пластину KRLY

Sipariş Örneği/Ordering Example/Образец заказа
1 ad./pcs./шт AAKT-K-R-2525-34-45-3-T17

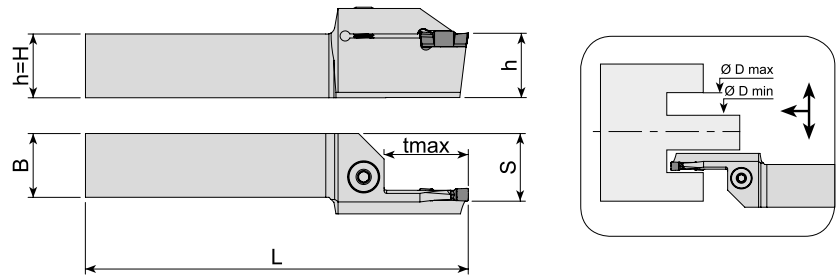

Takım Kodu Ordering Code Код для заказа	Stok Stock Наличие		Takım Ölçüleri (mm) Dimension (mm) Размеры (мм)							Kesici Uç Insert Пластина	Yedek Parçaları / Spare Parts / Запасные части			
	R	L	h=H	B	L	S	t max	Ø D min	Ø D max		Sıkma Vidası Screw Зажимной винт	Pul Stamp Шайба	Anahtar Allen Key Ключ	
AAKT-IG-R/L-2525-40-60-4-T25	●	●	25	25	150	26.5	25	40	60	DGN / GRP - 4	2004-M8x1x20	-	AAL-05-4	
AAKT-IG-R/L-2525-52-80-4-T25	●	●	25	25	150	26.5	25	52	80					
AAKT-IG-R/L-2525-70-110-4-T28	●	●	25	25	150	26.5	28	70	110					
AAKT-IG-R/L-2525-72-110-4-T25	○	○	25	25	150	26.5	25	72	110					
AAKT-IG-R/L-2525-100-150-4-T25	●	○	25	25	150	26.5	25	100	150					
AAKT-IG-R/L-2525-110-200-4-T28	●	○	25	25	150	26.5	28	110	200					
AAKT-IG-R/L-2525-110-200-4-T32	●	●	25	25	150	26.5	32	110	200					
AAKT-IG-R/L-2525-140-200-4-T25	○	○	25	25	150	26.5	25	140	200					
AAKT-IG-R/L-2525-180-800-4-T28	●	●	25	25	150	26.5	28	180	800					
AAKT-IG-R/L-2525-200-800-4-T25	○	○	25	25	150	26.5	25	200	800					
AAKT-IG-R/L-2525-70-110-5-T32	●	●	25	25	150	26.5	32	70	110	DGN / GRP - 5				
AAKT-IG-R/L-2525-110-200-5-T32	●	●	25	25	150	26.5	32	110	200					
AAKT-IG-R/L-2525-180-800-5-T32	●	●	25	25	150	26.5	32	180	800					
AAKT-IG-R/L-2525-58-100-6-T32	●	○	25	25	150	26.5	32	58	100	DGN / GRP - 6				
AAKT-IG-R/L-2525-88-180-6-T32	●	○	25	25	150	26.5	32	88	180					

ISCR Ucuna Uygundur. / Compatible with ISCR Insert. / Под пластину ISCR

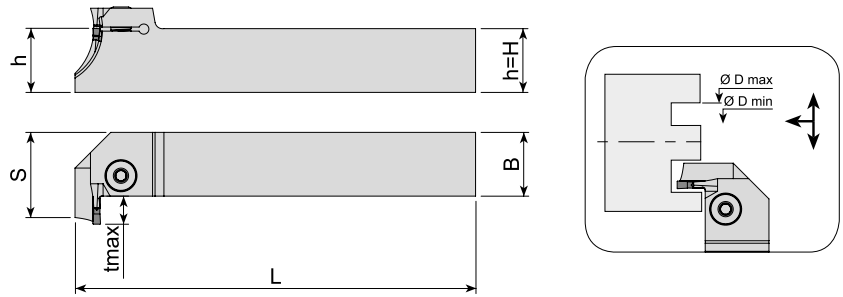

Takım Kodu Ordering Code Код для заказа	Stok Stock Наличие		Takım Ölçüleri (mm) Dimension (mm) Размеры (мм)							Kesici Uç Insert Пластина	Yedek Parçaları / Spare Parts / Запасные части			
	R	L	h=H	B	L	S	t max	Ø D min	Ø D max		Sıkma Vidası Screw Зажимной винт	Pul Stamp Шайба	Anahtar Allen Key Ключ	
ALKT-ZCC2-R/L-2525-35-45-3-T10	●	●	25	25	150	36	10	35	45	Z.FD - 3	2004-M8x1x20	-	AAL-05-4	
ALKT-ZCC2-R/L-2525-39-55-3-T10	●	●	25	25	150	36	10	39	55					
ALKT-ZCC2-R/L-2525-35-∞-3-T4	●	●	25	25	150	30	4	35	∞					
ALKT-ZCC2-R/L-2525-40-60-4-T14	●	●	25	25	150	40	14	40	60					
ALKT-ZCC2-R/L-2525-52-80-4-T14	●	○	25	25	150	40	14	52	80					
ALKT-ZCC2-R/L-2525-72-110-4-T14	●	○	25	25	150	40	14	72	110	Z.GD - 4				
ALKT-ZCC2-R/L-2525-100-230-4-T14	●	○	25	25	150	40	14	100	230					
ALKT-ZCC2-R/L-2525-40-∞-4-T4	●	●	25	25	150	30	4	40	∞					

R: Sağ / Right / Правый L: Sol/Left/Левый
● Stokta / In Stock / В наличии ○ Stokta Yok / Non Stock Item / Нет в наличии
ZCC Ucuna Uygundur. / Compatible with ZCC Insert. / Под пластину ZCC

Sipariş Örneği/Ordering Example/Образец заказа
1 ad./pcs./шт AAKT-IG-R-2525-40-60-4-T25

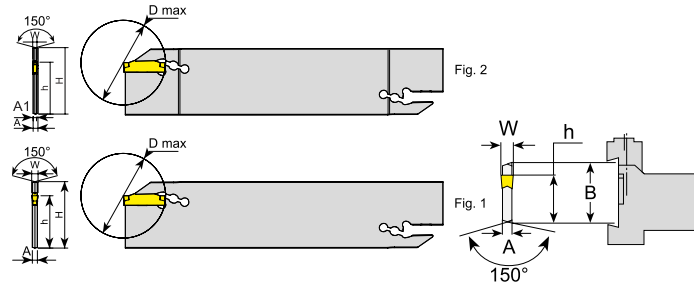

Takım Kodu Ordering Code Код для заказа	Stok Stock Наличие	Takım Ölçüleri (mm) Dimension (mm) Размеры (мм)								Kesici Uç Insert Пластина	Yedek Parçaları / Spare Parts Зачасные части	Anahtar Allen Key Ключ
		B	W	A	A1	l	h	D max	Fig.			
AKL-TD-32-2	●	32	2	2.4	1.6	150	25	39	2			
AKL-TD-32-3	●	32	3	2.4	-	150	25	39	1	TD - 3		

TGTC Ucuna Uygunur. / Compatiple with TGTC Insert. / Под пластину TGTC

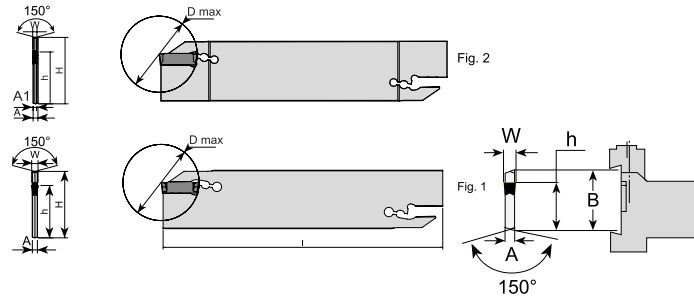

Takım Kodu Ordering Code Код для заказа	Stok Stock Наличие	Takım Ölçüleri (mm) Dimension (mm) Размеры (мм)								Kesici Uç Insert Пластина	Yedek Parçaları / Spare Parts Зачасные части	Anahtar Allen Key Ключ
		B	W	A	A1	l	h	D max	Fig.			
AKL-I-26-2	●	26	1.9-2.5	1.6	-	110	21.4	39	1			
AKL-I-32-2	●	32	1.9-2.5	2.4	1.8	150	25	39	2			
AKL-I-26-3	●	26	3-3.18	2.4	-	110	21.4	39	1	DGN - 3	ALA-01	
AKL-I-32-3	●	32	3-3.18	2.4	-	150	25	39	1			
AKL-I-26-4	●	26	4	3.2	-	110	21.4	80	1	DGN / GRP - 4		
AKL-I-32-4	●	32	4	3.2	-	150	25	100	1			

R: Sağ / Right / Правый L: Sol/Left/Левый

● Stokta / In Stock / В наличии ○ Stokta Yok / Non Stock Item / Нет в наличии
 ISCR Ucuna Uygunur. / Compatiple with ISCR Insert. / Под пластину ISCR

Sipariş Örneği/Ordering Example/Образец заказа

1 ad./pcs./шт AKL-TD-32-2



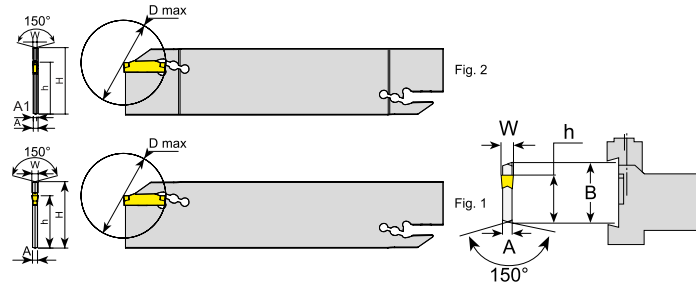

Takım Kodu Ordering Code Код для заказа	Stok Stock Наличие	Takım Ölçüleri (mm) Dimension (mm) Размеры (мм)								Kesici Uç Insert Пластина	Yedek Parçaları / Spare Parts / Залпасные части	
		B	W	A	A1	l	h	D max	Fig.		Anahtar Allen Key Ключ	
AKL-123-32-2	●	32	2	2.4	1.6	150	25	39	2			
AKL-123-32-3	●	32	3	2.4	-	150	25	39	1	123 - 3		
AKL-123-32-4	●	32	4	3.2	-	150	25	39	1	123 - 4		

SNDVK Ucuna Uygun dur. / Compatiple with SNDVK Insert. / Под пластину SNDVK

KESME VE DERİN KANAL AÇMA LAMA BLOĞU
BLOCKS FOR PARTING AND DEEP GROOVING BLADES
БЛОКИ К СМЕННЫМ НОЖАМ ДЛЯ ОТРЕЗКИ И ОБРАБОТКИ ГЛУБОКИХ КАНАВОК

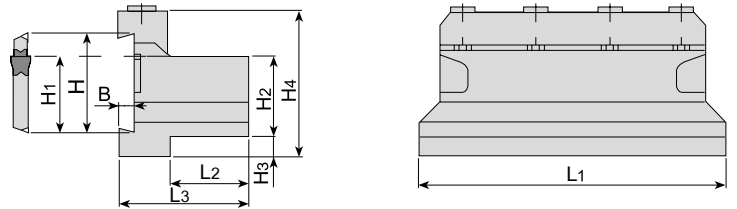

Takım Kodu Ordering Code Код для заказа	Stok Stock Наличие	Takım Ölçüleri (mm) Dimension (mm) Размеры (мм)									Yedek Parçaları / Spare Parts / Залпасные части		
		H	H1	H2	H3	H4	B	L1	L2	L3	Pabuç Clamp Прижим	Pabuç Vidası Clamp Screw Винт прижима	Anahtar Allen Key Ключ
ALBU-20-26	●	26	21.4	20	8	38	4	87	19	33		2505-M6x25	
ALBU-25-26	●	26	21.4	25	3	38	4	110	20	34	ABK-02		
ALBU-20-32	●	32	25	20	13	48	5.5	100	19	35	ABK-03	2505-M6x30	
ALBU-25-32	●	32	25	25	8	48	5.5	110	20	36	ABK-04		
ALBU-32-32	●	32	25	32	3	48	5.5	120	28	44			

R: Sağ / Right / Правый L: Sol/Left/Левый

● Stokta / In Stock / В наличии ○ Stokta Yok / Non Stock Item / Нет в наличии

Sipariş Örneği/Ordering Example/Образец заказа
1 ad./pcs./шт AKL-123-32-3

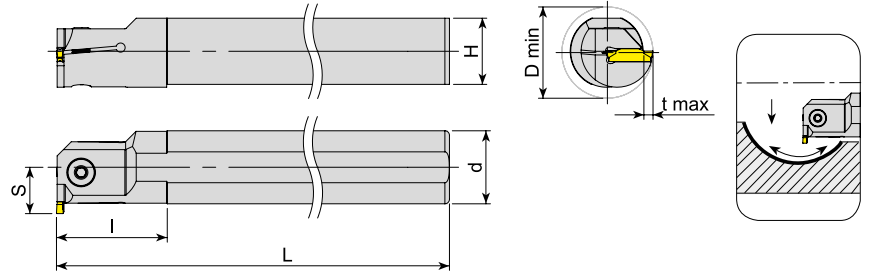
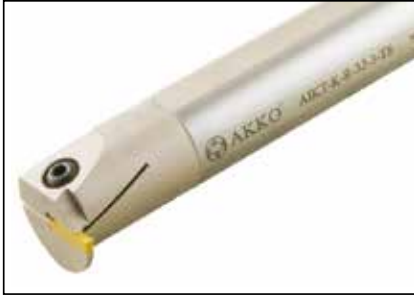

Takım Kodu Ordering Code Код для заказа	Stok Stock Наличие		Takım Ölçüleri (mm) Dimension (mm) Размеры (мм)							Kesici Uç Insert Пластина	Yedek Parçaları / Spare Parts / Запасные части	
	R	L	d	D min	L	l	t max	H	S		Sıkma Vidası Screw Зажимной винт	Anahtar Allen Key Ключ
AIKT-K-R/L-16-2-T4	●	●	16	21	150	28	4	14.8	12	MGM. - 2	2503-M4x10	AAL-03-3
AIKT-K-R/L-20-2-T4	●	●	20	25	170	30	4	18.3	14		2503-M4x12	
AIKT-K-R/L-25-2-T6	●	●	25	32	200	40	6	23	18.5		2504-M5x12	
AIKT-K-R/L-20-3-T6	●	●	20	27	170	30	6	18.3	16	MGM. - 3	2504-M5x12	AAL-05-4
AIKT-K-R/L-20-3-T7	●	●	20	25	170	38	7	18.3	13		2504-M5x16	
AIKT-K-R/L-25-3-T6	●	●	25	32	200	40	6	23	18.5		2504-M5x16	
AIKT-K-R/L-25-3-T10	●	●	25	32	200	48	10	23	17		2004-M8x1x20	
AIKT-K-R/L-32-3-T6	●	●	32	39	250	50	6	30	22		2504-M5x12	
AIKT-K-R/L-32-3-T12	●	●	32	39	250	53	12	30	22		2504-M5x16	
AIKT-K-R/L-40-3-T6	●	●	40	47	300	55	6	37.5	26		2004-M8x1x20	
AIKT-K-R/L-40-3-T12	●	○	40	48	300	63	12	37.5	27		2504-M5x12	
AIKT-K-R/L-20-4-T6	●	●	20	27	170	30	6	18.3	16		2504-M5x16	
AIKT-K-R/L-20-4-T7	●	○	20	25	170	38	7	18.3	13		2504-M5x16	
AIKT-K-R/L-25-4-T6	●	●	25	32	200	40	6	23	18.5	2004-M8x1x20		
AIKT-K-R/L-25-4-T10	●	●	25	32	200	49	10	23	17	2504-M5x12		
AIKT-K-R/L-32-4-T6	●	●	32	39	250	50	6	30	22	2504-M5x16		
AIKT-K-R/L-32-4-T12	●	●	32	39	250	53	12	30	22	2004-M8x1x20		
AIKT-K-R/L-40-4-T6	●	●	40	47	300	55	6	37.5	26	2504-M5x16		
AIKT-K-R/L-40-4-T12	●	●	40	48	300	63	12	37.5	27	2004-M8x1x20		
AIKT-K-R/L-25-5-T7	●	●	25	33	200	40	7	23	19.5	2504-M5x16		
AIKT-K-R/L-32-5-T7	●	●	32	40	250	50	7	30	23	2004-M8x1x20		
AIKT-K-R/L-40-5-T7	●	●	40	48	300	55	7	37.5	27	2504-M5x16		
AIKT-K-R/L-40-5-T12	●	○	40	48	300	63	12	37.5	27	2004-M8x1x20		

R: Sağ / Right / Правый L: Sol/Left/Левый
● Stokta / In Stock / В наличии ○ Stokta Yok / Non Stock Item / Нет в наличии
KRLY Ucuna Uygunudur. / Compatible with KRLY Insert. / Под пластину KRLY

Sipariş Örneği/Ordering Example/Образец заказа
1 ad./pcs./шт AIKT-K-R-16-2-T4

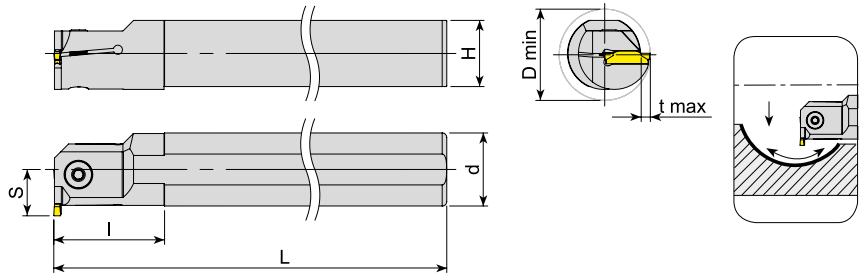

Takım Kodu Ordering Code Код для заказа	Stok Stock Наличие		Takım Ölçüleri (mm) Dimension (mm) Размеры (мм)							Kesici Uç Insert Пластина	Yedek Parçaları / Spare Parts / Запасные части	
	R	L	d	D min	L	l	t max	H	S		Sıkma Vidası Screw Зажимной винт	Anahtar Allen Key Ключ
AIKT-KG-R/L-25-2-T7	●	●	25	33	200	40	7	23	19.5	KG.. - 2	2504-M5x12	AAL-05-4
AIKT-KG-R/L-20-3-T6.5-H	●	○	20	27.5	170	30	6.5	18.3	16.5		KG.. - 3	
AIKT-KG-R/L-25-3-T7	○	○	25	33	200	40	7	23	19.5	2004-M8x1x20		
AIKT-KG-R/L-40-3-T8	●	○	40	50	300	55	8	37.5	28		KG.. - 4	
AIKT-KG-R/L-25-4-T8	●	●	25	34	200	40	8	23	20.5			

KRLY Ucuna Uygun. / Compatible with KRLY Insert. / Под пластину KRLY

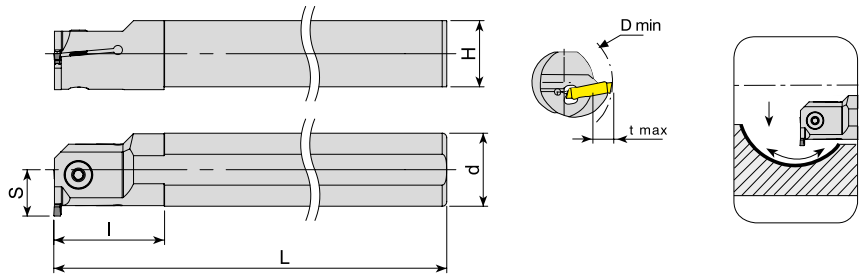

Takım Kodu Ordering Code Код для заказа	Stok Stock Наличие		Takım Ölçüleri (mm) Dimension (mm) Размеры (мм)							Kesici Uç Insert Пластина	Yedek Parçaları / Spare Parts / Запасные части	
	R	L	d	D min	L	l	t max	H	S		Sıkma Vidası Screw Зажимной винт	Anahtar Allen Key Ключ
AIKT-H-R/L-25-3-T8	●	●	25	34	200	40	8	23	20.5	S229 - 3	2504-M5x16	AAL-05-4
AIKT-H-R/L-32-3-T7	●	●	32	40	250	50	7	30	23		2004-M8x1x20	
AIKT-H-R/L-40-3-T7	●	●	40	48	300	55	7	37.5	27	S229 - 4		
AIKT-H-R/L-25-4-T8	●	●	25	34	200	40	8	23	20.5		2004-M8x1x20	
AIKT-H-R/L-32-4-T7	●	●	32	40	250	50	7	30	23	S229 - 5		
AIKT-H-R/L-40-4-T7	●	●	40	48	300	55	7	37.5	27		2004-M8x1x20	
AIKT-H-R/L-25-5-T8	●	●	25	34	200	40	8	23	20.5			
AIKT-H-R/L-32-5-T7	●	○	32	40	250	50	7	30	23			
AIKT-H-R/L-40-5-T7	●	○	40	48	300	55	7	37.5	27			

R: Sağ / Right / Правый L: Sol/Left/Левый

● Stokta / In Stock / В наличии ○ Stokta Yok / Non Stock Item / Нет в наличии

HRN Ucuna Uygun. / Compatible with HRN Insert. / Под пластину HRN

Sipariş Örneği/Ordering Example/Образец заказа

1 ad./pcs./шт AIKT-KG-R-25-2-T7

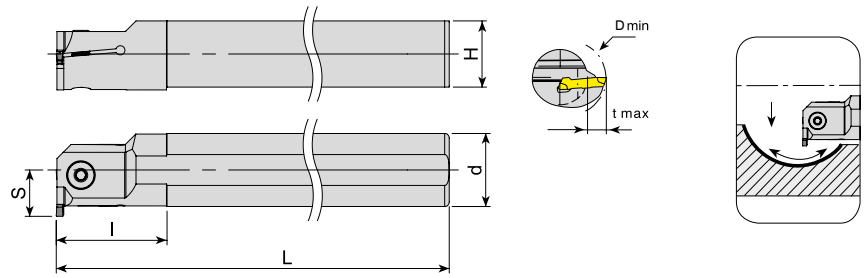

Takım Kodu Ordering Code Код для заказа	Stok Stock Наличие		Takım Ölçüleri (mm) Dimension (mm) Размеры (мм)							Kesici Uç Insert Пластина	Yedek Parçaları / Spare Parts / Запасные части	
	R	L	d	D min	L	l	t max	H	S		Sıkma Vidası Screw Зажимной винт	Anahtar Allen Key Ключ
AIKT-HK-R/L-20-2-T6	●	●	20	26	170	30	6	18.3	16	S224 - 2	2503-M4x12	AAL-03-3
AIKT-HK-R/L-25-2-T6	●	○	25	32	200	40	6	23	18.5		2504-M5x16	AAL-05-4
AIKT-HK-R/L-20-3-T6	●	○	20	27	170	30	6	18.3	16	S224 - 3	2504-M5x12	
AIKT-HK-R/L-25-3-T6	●	●	25	32	200	40	6	23	18.5		2504-M5x16	
AIKT-HK-R/L-32-3-T6	●	●	32	39	250	50	6	30	22	S224 - 4	2004-M8x1x20	AAL-05-4
AIKT-HK-R/L-20-4-T6	●	○	20	27	170	30	6	18.3	16		2504-M5x12	
AIKT-HK-R/L-25-4-T6	●	○	25	32	200	40	6	23	18.5	S224 - 4	2504-M5x16	AAL-05-4
AIKT-HK-R/L-32-4-T6	●	○	32	39	250	50	6	30	22		2004-M8x1x20	
AIKT-HS223-R/L-20-2-T5	●	○	20	26	170	33	5	18.3	15	S223 - 2	2503-M4x12	AAL-03-3
AIKT-HS223-R/L-25-2-T5	●	○	25	31	200	40	5	23	17.5		2504-M5x16	AAL-05-4
AIKT-HS223-R/L-20-3-T6	●	○	20	27	170	33	6	18.3	16	S223 - 3	2504-M5x12	
AIKT-HS223-R/L-25-3-T6	●	○	25	32	200	40	6	23	18.5		2504-M5x16	

HRN Ucuna Uygundur. / Compatible with HRN Insert. / Под пластину HRN

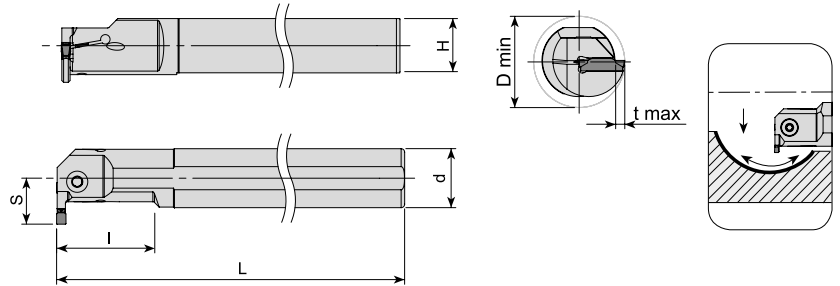

Takım Kodu Ordering Code Код для заказа	Stok Stock Наличие		Takım Ölçüleri (mm) Dimension (mm) Размеры (мм)							Kesici Uç Insert Пластина	Yedek Parçaları / Spare Parts / Запасные части	
	R	L	d	D min	L	l	t max	H	S		Sıkma Vidası Screw Зажимной винт	Anahtar Allen Key Ключ
AIKT-KM-R/L-20-2-T7	●	●	20	25	170	40	7	18.3	13	A4. - 2	2503-M4x12	AAL-03-3
AIKT-KM-R/L-20-3-T7	●	○	20	25	170	40	7	18.3	13		2504-M5x12	AAL-05-4
AIKT-KM-R/L-25-3-T10	●	●	25	32	200	50	10	23	17	A4. - 3	2505-M6x16	AAL-07-5
AIKT-KM-R/L-32-3-T12	●	●	32	40	250	64	12	30	22		2505-M6x20	
AIKT-KM-R/L-40-3-T12	●	●	40	48	300	80	12	37.5	27	A4. - 4	2504-M5x12	AAL-05-4
AIKT-KM-R/L-20-4-T7	●	○	20	25	170	40	7	18.3	13			

R: Sağ / Right / Правый L: Sol/Left/Левый

● Stokta / In Stock / В наличии ○ Stokta Yok / Non Stock Item / Нет в наличии

KNMNTL Ucuna Uygundur. / Compatible with KNMNTL Insert. / Под пластину KNMNTL



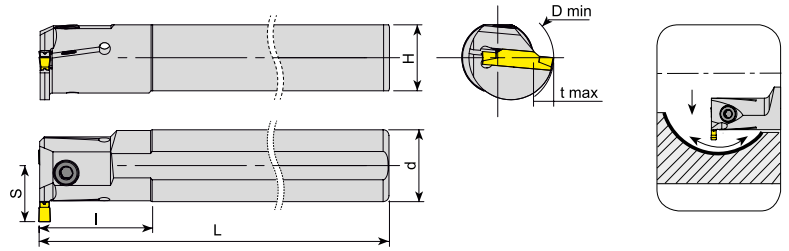

Takım Kodu Ordering Code Код для заказа	Stok Stock Наличие		Takım Ölçüleri (mm) Dimension (mm) Размеры (мм)							Kesici Uç Insert Пластина	Yedek Parçaları / Spare Parts / Залпасные части			
	R	L	d	D min	L	l	t max	H	S		Sıkma Vidası Screw Зажимной винт	Anahtar Allen Key Ключ		
AIKT-123-R/L-20-2-T6	●	○	20	32	170	30	6	18.3	16	123 - 2				
AIKT-123-R/L-25-2-T6	●	○	25	32	200	40	6	18.3	18.5					2504-M5x12
AIKT-123-R/L-32-2-T7	●	○	32	41	250	45	7	30	23					2004-M8x1x20
AIKT-123-R/L-20-3-T6	●	○	20	32	170	30	6	18.3	16	123 - 3			AAL-05-4	
AIKT-123-R/L-25-3-T7	●	○	25	32	200	40	7	23	19.5					2504-M5x16
AIKT-123-R/L-32-3-T9	●	○	32	41	250	50	9	30	25					2004-M8x1x20
AIKT-123-R/L-20-4-T8	●	○	20	29	170	30	8	18.3	18	123 - 4			AAL-05-4	
AIKT-123-R/L-25-4-T7	●	○	25	32	200	40	7	23	19.5					2504-M5x16
AIKT-123-R/L-32-4-T7	●	●	32	41	250	45	7	30	23					2004-M8x1x20
AIKT-123-R/L-32-4-T10	●	○	32	43	250	50	10	30	26	123 - 5			AAL-05-4	
AIKT-123-R/L-25-5-T8	●	○	25	34	200	40	8	23	20.5					2504-M5x16
AIKT-123-R/L-32-5-T11	●	●	32	43	250	50	11	30	27					2004-M8x1x20

SNDVK Uсuna Uygundur. / Compatiple with SNDVK Insert. / Под пластину SNDVK

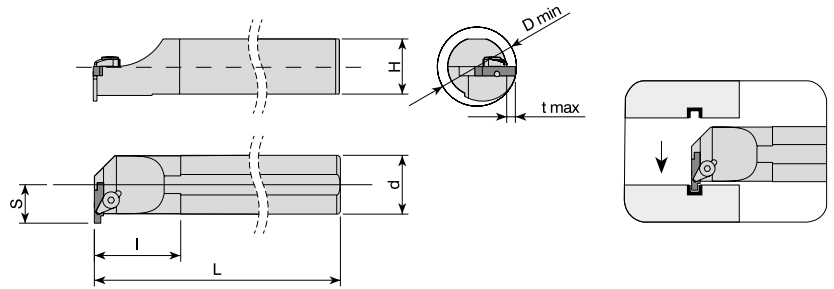

Takım Kodu Ordering Code Код для заказа	Stok Stock Наличие		Takım Ölçüleri (mm) Dimension (mm) Размеры (мм)							Kesici Uç Insert Пластина	Baskı Parçası Wedge Clamp Прижим	Sıkma Vidası Screw Зажимной винт	Pim Pin Штифт	Anahtar Allen Key Ключ				
	R	L	d	D min	L	l	t max	H	S									
AIKT-154.91-R/L-16-3-T3	●	●	16	20	150	35	3	14.8	11	154.91 - 3								
AIKT-154.91-R/L-20-3-T4	●	●	20	25	170	38	4	18.3	14							ACK-06	AKV-10-M6x14	AAL-05-4
AIKT-154.91-R/L-25-3-T4	●	●	25	31	200	40	4	23	16.5							ACK-03	AKV-21-M6x18	APM-06
AIKT-154.91-R/L-25-5-T5	●	●	25	31	200	45	5	23	17.5	AKV-07-M6x22								
AIKT-154.91-R/L-32-5-T5	●	●	32	38	250	50	5	30	21									

R: Sağ / Right / Правый L: Sol/Left/Левый

● Stokta / In Stock / В наличии ○ Stokta Yok / Non Stock Item / Нет в наличии

SNDVK Uсuna Uygundur. / Compatiple with SNDVK Insert. / Под пластину SNDVK

Sipariş Örneği/Ordering Example/Образец заказа

1 ad./pcs./шт AIKT-123-R-32-2-T7

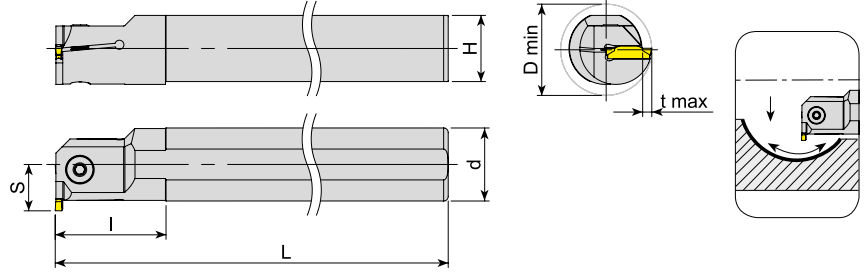

Takım Kodu Ordering Code Код для заказа	Stok Stock Наличие		Takım Ölçüleri (mm) Dimension (mm) Размеры (мм)							Kesici Uç Insert Пластина	Yedek Parçaları / Spare Parts / Залпасные части	
	R	L	d	D min	L	l	t max	H	S		Sıkma Vidası Screw Зажимной винт	Anahtar Allen Key Ключ
AIKT-ZCC2-R/L-16-2-T4	●	○	16	21	150	28	4	14.8	12	Z.BD - 2	2503-M4x10	AAL-03-3
AIKT-ZCC2-R/L-20-3-T5	●	●	20	27	170	30	5	18.3	15		Z.FD - 3	2504-M5x12
AIKT-ZCC2-R/L-20-3-T8	●	○	20	29	170	30	8	18.3	18	2504-M5x16		
AIKT-ZCC2-R/L-25-3-T5	●	○	25	31	200	40	5	23	17.5	2004-M8x1x20		
AIKT-ZCC2-R/L-25-3-T10	●	○	25	36	200	40	10	23	22.5	2504-M5x12		
AIKT-ZCC2-R/L-32-3-T6	●	○	32	39	250	50	6	30	22	2504-M5x16		
AIKT-ZCC2-R/L-32-3-T8	●	○	32	41	250	50	8	30	24	2004-M8x1x20		
AIKT-ZCC2-R/L-32-3-T13	●	○	32	46	250	50	13	30	29	2504-M5x12		
AIKT-ZCC2-R/L-40-3-T12	●	○	40	53	300	55	12	37.5	32	2504-M5x16		
AIKT-ZCC2-R/L-25-4-T6	●	○	25	32	200	40	6	23	18.5	Z.GD - 4	2004-M8x1x20	
AIKT-ZCC2-R/L-32-4-T7	●	○	32	40	250	50	7	30	23			
AIKT-ZCC2-R/L-32-4-T8	●	○	32	41	250	50	8	30	24	Z.HD - 5	2004-M8x1x20	
AIKT-ZCC2-R/L-32-4-T10	●	○	32	43	250	50	10	30	26			
AIKT-ZCC2-R/L-32-5-T7	●	○	32	40	250	50	7	30	23	Z.HD - 5	2004-M8x1x20	
AIKT-ZCC2-R/L-32-5-T8	●	○	32	41	250	50	8	30	24			
AIKT-ZCC2-R/L-40-5-T8	●	○	40	49	300	55	8	37.5	28			
AIKT-ZCC2-R/L-40-5-T10	●	○	40	51	300	55	10	37.5	30			

ZCC Ucuna Uygundur. / Compatible with ZCC Insert. / Под пластину ZCC

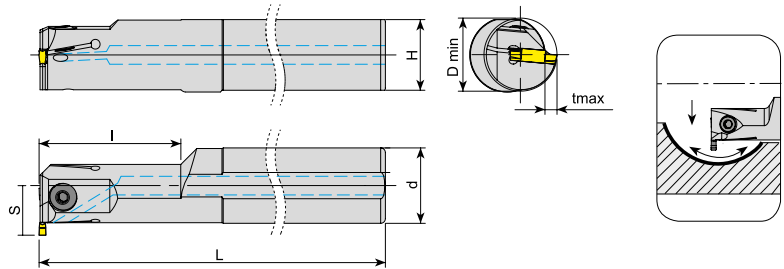

Takım Kodu Ordering Code Код для заказа	Stok Stock Наличие		Takım Ölçüleri (mm) Dimension (mm) Размеры (мм)							Kesici Uç Insert Пластина	Yedek Parçaları / Spare Parts / Залпасные части	
	R	L	d	D min	L	l	t max	H	S		Sıkma Vidası Screw Зажимной винт	Anahtar Allen Key Ключ
AIKT-TD-R-16-2-T8.5-H	●	○	16	25	150	28	8.5	14.8	16.5	TD-2	2503-M4x10	AAL-03-3
AIKT-TD-R-20-3-T6-H	●	○	20	25	170	40	6	18.3	16	TD-3	2504-M5x12	AAL-05-4
AIKT-TD-R-25-3-T6-H	●	○	25	25	200	40	6	23	18.5		2004-M8x1x20	
AIKT-TD-R-32-3-T5-H	●	○	32	31	250	60	5	30	21			

R: Sağ / Right / Правый L: Sol/Left/Левый

● Stokta / In Stock / В наличии ○ Stokta Yok / Non Stock Item / Нет в наличии
TGTC Ucuna Uygundur. / Compatible with TGTC Insert. / Под пластину TGTC

Sipariş Örneği/Ordering Example/Образец заказа

1 ad./pcs./шт AIKT-ZCC-R-20-3-T5



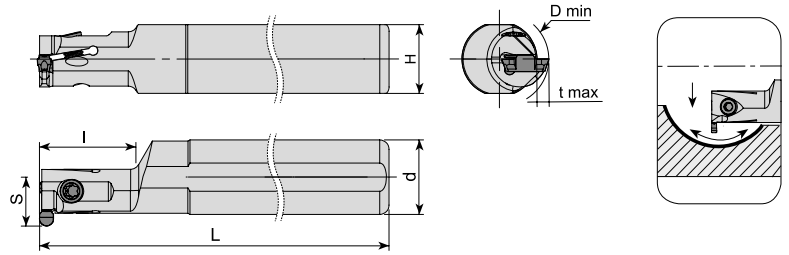

Takım Kodu Ordering Code Код для заказа	Stok Stock Наличие		Takım Ölçüleri (mm) Dimension (mm) Размеры (мм)							Kesici Uç Insert Пластина	Yedek Parçaları / Spare Parts / Запасные части	
	R	L	d	D min	L	I	t max	H	S		Sıkma Vidası Screw Зажимной винт	Tork Anahtar Torx Key Торк Ключ
AIKT-IGE-R/L-10-2-T3-H	●	○	10	11.5	125	25	3	9	8.3	GEPI - 2	1315-M4x11	80-T15
AIKT-IGE-R/L-16-2-T2.5-H	●	●	16	13	125	20	2.5	14.8	10.5			
AIKT-IGE-R/L-16-3-T2.5-H	●	○	16	13	125	20	2.5	14.8	10.5	GEPI - 3	1315-M4x11	80-T15
AIKT-IGE-R/L-16-3-T2.5-D20	●	○	16	20	125	28	2.5	14.8	10.5			

ISCR Ucuna Uygunudur. / Compatible with ISCR Insert. / Под пластину ISCR

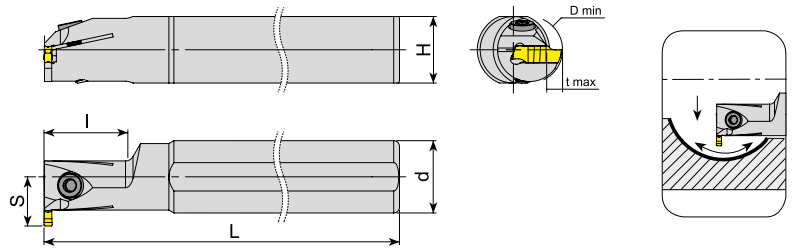

Takım Kodu Ordering Code Код для заказа	Stok Stock Наличие		Takım Ölçüleri (mm) Dimension (mm) Размеры (мм)							Kesici Uç Insert Пластина	Yedek Parçaları / Spare Parts / Запасные части	
	R	L	d	D min	L	I	t max	H	S		Sıkma Vidası Screw Зажимной винт	Anahtar Allen Key Ключ
AIKT-IGI-R/L-20-3-T4	●	●	20	20	170	25	4	18.3	14.5	GIMIY / GIPI - 3	1020-M5x14	80-T20
AIKT-IGI-R/L-25-3-T5	●	●	25	23	200	30	5	23	17		2504-M5x16	
AIKT-IGI-R/L-32-3-T5	●	●	32	31	250	30	5	30	21		2004-M8x1x20	AAL-05-4
AIKT-IGI-R/L-40-3-T5	●	○	40	50	300	50	5	37.5	25	GIMIY / GIPI - 4	1020-M5x14	80-T20
AIKT-IGI-R/L-20-4-T4	●	●	20	20	170	25	4	18.3	14.5		GIMIY / GIPI - 5	2504-M5x16
AIKT-IGI-R/L-25-5-T10	●	○	25	32	200	25	10	23	22.5	GIMIY / GIPI - 5		2504-M5x16
AIKT-IGI-R/L-25-5-T15	●	○	25	37	200	25	15	23	27.5			

R: Sağ / Right / Правый L: Sol/Left/Левый
● Stokta / In Stock / В наличии ○ Stokta Yok / Non Stock Item / Нет в наличии
ISCR Ucuna Uygunudur. / Compatible with ISCR Insert. / Под пластину ISCR

Sipariş Örneği/Ordering Example/Образец заказа
1 ad./pcs./шт AIKT-IGE-R-10-2-T3-H

Note: "I" boyları D min çapa göre verilmiştir.
Note: Lengths of "I" are given according to D min diameter.
Примечание: размеры I должны быть D min.

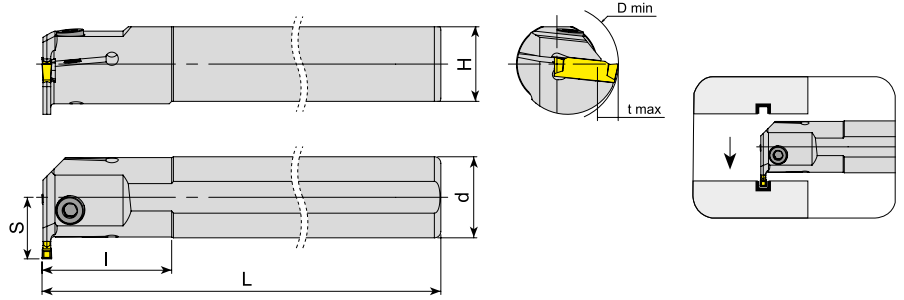

Takım Kodu Ordering Code Код для заказа	Stok Stock Наличие		Takım Ölçüleri (mm) Dimension (mm) Размеры (мм)							Kesici Uç Insert Пластина	Yedek Parçaları / Spare Parts / Запасные части		
	R	L	d	D min	L	I	t max	H	S		Sıkma Vidası Screw Зажимной винт	Anahtar Allen Key Ключ	
AIKT-I-R/L-20-3-T5	●	●	20	26	170	25	5	18.3	15.5	DGN - 3	2504-M5x12	AAL-05-4	
AIKT-I-R/L-25-3-T6	●	●	25	32	200	40	6	23	19		2504-M5x16		

ISCR Uçuna Uygundur. / Compatible with ISCR Insert. / Под пластину ISCR

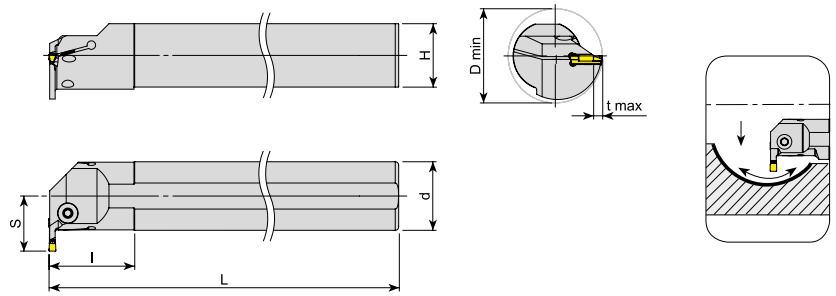

Takım Kodu Ordering Code Код для заказа	Stok Stock Наличие		Takım Ölçüleri (mm) Dimension (mm) Размеры (мм)							Kesici Uç Insert Пластина	Yedek Parçaları / Spare Parts / Запасные части		
	R	L	d	D min	L	I	t max	H	S		Sıkma Vidası Screw Зажимной винт	Anahtar Allen Key Ключ	
AIKT-IG-R/L-25-4-T10-H	●	●	25	36	200	40	10	23	22.7	DGN / GRP - 4	2504-M5X16	AAL-05-4	
AIKT-IG-R/L-32-4-T10-H	●	●	32	43	250	45	10	30	26.2		2004-M8x1x20		
AIKT-IG-R/L-40-4-T12-H	●	●	40	53	300	50	12	37.5	32.2		2504-M5X16		
AIKT-IG-R/L-25-5-T10-H	●	○	25	36	200	40	10	23	22.7	DGN / GRP - 5	2504-M5X16		
AIKT-IG-R/L-32-5-T10-H	●	○	32	43	250	45	10	30	26.2		2004-M8x1x20		
AIKT-IG-R/L-40-5-T12-H	●	○	40	53	250	50	12	37.5	32.2		2004-M8x1x20		
AIKT-IG-R/L-50-5-T12-H	●	○	50	63	300	60	12	47	37.2				

R: Sağ / Right / Правый L: Sol/Left/Левый
● Stokta / In Stock / В наличии ○ Stokta Yok / Non Stock Item / Нет в наличии
ISCR Uçuna Uygundur. / Compatible with ISCR Insert. / Под пластину ISCR

Sipariş Örneği/Ordering Example/Образец заказа
1 ad./pcs./шт AIKT-I-R-20-3-T5

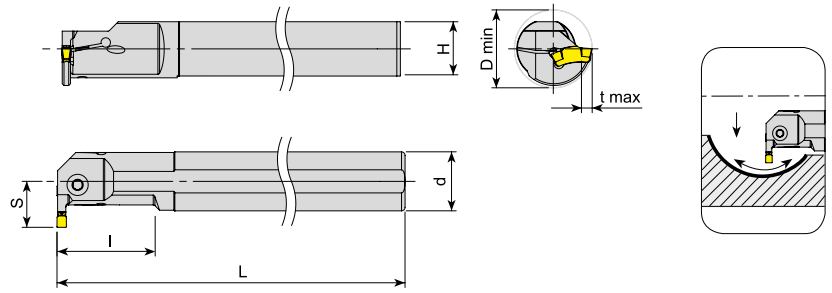

Takım Kodu Ordering Code Код для заказа	Stok Stock Наличие		Takım Ölçüleri (mm) Dimension (mm) Размеры (мм)							Kesici Uç Insert Пластина	Yedek Parçaları / Spare Parts / Запасные части	
	R	L	d	D min	L	I	t max	H	S		Sıkma Vidası Screw Зажимной винт	Anahtar Allen Key Ключ
AIKT-ITG-R/L-16-3-T6-H	●	●	16	20	150	25	6	14.8	12	TGM. - 3	1020-M4.5X14	80-T20
AIKT-ITG-R/L-20-3-T6-H	●	●	20	25	170	32	6	18.3	14.2		1020-M4.5X16	
AIKT-ITG-R/L-25-3-T8-H	●	●	25	32	200	40	8	23	18.8		2504-M5X16	AAL-05-4
AIKT-ITG-R/L-32-3-T8-H	●	●	32	38	250	49	8	30	22		2004-M8x1x20	
AIKT-ITG-R/L-20-4-T6-H	●	●	20	25	170	33	6	18.3	14.2	TGM. - 4	1020-M4.5X16	80-T20
AIKT-ITG-R/L-25-4-T7-H	●	●	25	31	200	41	7	23	17.5		2504-M5X16	AAL-05-4
AIKT-ITG-R/L-25-4-T9-H	●	●	25	32.5	200	41	9	23	19.5		2004-M8x1x20	
AIKT-ITG-R/L-32-4-T11-H	●	●	32	42	250	50	11	30	25.5			
AIKT-ITG-R/L-40-4-T11-H	●	●	40	53	300	50	11	37.5	32	TGM. - 6.35	2004-M8x1x20	
AIKT-ITG-R/L-32-6.35-T17.5-H	●	●	32	57	250	50	17.5	30	29			

ISCR Ucuna Uygundur. / Compatible with ISCR Insert. / Под пластину ISCR

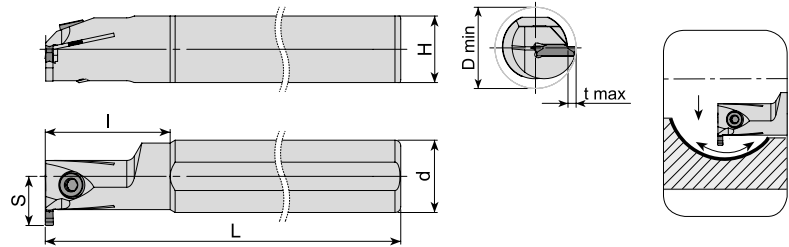

Takım Kodu Ordering Code Код для заказа	Stok Stock Наличие		Takım Ölçüleri (mm) Dimension (mm) Размеры (мм)							Kesici Uç Insert Пластина	Yedek Parçaları / Spare Parts / Запасные части	
	R	L	d	D min	L	I	t max	H	S		Sıkma Vidası Screw Зажимной винт	Anahtar Allen Key Ключ
AIKT-GP-R/L-20-2-T4	●	○	20	25	170	30	4	18.3	14.5	GP - 2	2503-M4x12	AAL-03-3
AIKT-GP-R/L-25-2-T6	●	○	25	32	200	40	6	23	18.5			
AIKT-GP-R/L-20-3-T6	●	○	20	27	170	30	6	18.3	16	GP - 3	2504-M5x16	AAL-05-4
AIKT-GP-R/L-25-3-T6	●	○	25	32	200	40	6	23	18.5			
AIKT-GP-R/L-32-3-T6	●	○	32	39	250	50	6	30	22	2004-M8x1x20		
AIKT-GP-R/L-20-4-T6	●	○	20	27	170	30	6	18.3	16	GP - 4	2504-M5x16	
AIKT-GP-R/L-25-4-T6	●	○	25	32	200	40	6	23	18.5		2004-M8x1x20	
AIKT-GP-R/L-32-4-T6	●	○	32	39	250	50	6	30	22			

R: Sağ / Right / Правый L: Sol/Left/Левый

● Stokta / In Stock / В наличии ○ Stokta Yok / Non Stock Item / Нет в наличии
PLBT Ucuna Uygundur. / Compatible with PLBT Insert. / Под пластину PLBT

Sipariş Örneği/Ordering Example/Образец заказа

1 ad./pcs./шт AIKT-ITG-R-16-3-T6-H

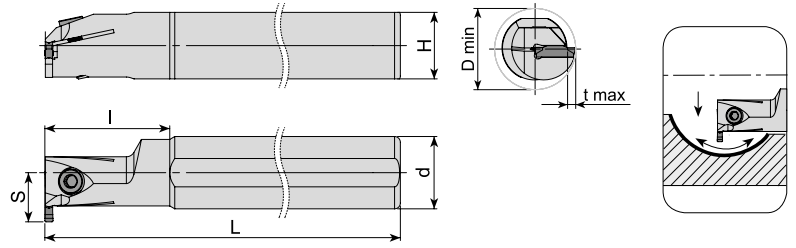

Takım Kodu Ordering Code Код для заказа	Stok Stock Наличие		Takım Ölçüleri (mm) Dimension (mm) Размеры (мм)							Kesici Uç Insert Пластина	Yedek Parçaları / Spare Parts / Запасные части	
	R	L	d	D min	L	l	t max	H	S		Sıkma Vidası Screw Зажимной винт	Anahtar Allen Key Ключ
AIKT-SGC-R-25-3-T6	●	○	25	32	200	40	6	23	18.5	GCM N30	2504-M5x16 2004-M8x1x20	AAL-05-4
AIKT-SGC-R-32-3-T6	●	○	32	39	250	50	6	30	22			
AIKT-SGC-R-40-3-T6	●	○	40	47	300	55	6	37.5	26			

SMTM Ucuna Uygun. / Compatible with SMTM Insert. / Под пластину SMTM

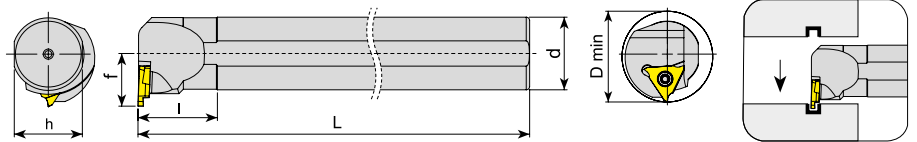





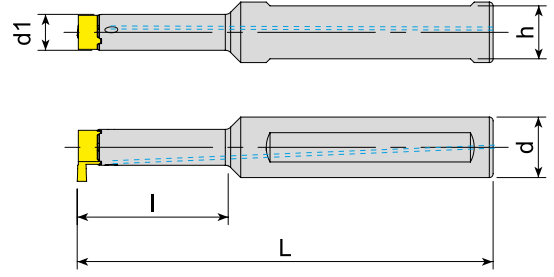

Takım Kodu Ordering Code Код для заказа	Stok Stock Наличие		Takım Ölçüleri (mm) Dimension (mm) Размеры (мм)							Kesici Uç Insert Пластина	Yedek Parçaları / Spare Parts / Запасные части	
	R	L	d	D min	L	l	t max	H	S		Sıkma Vidası Screw Зажимной винт	Tork Anahtar Torx Key Торх Ключ
AIKT-QC11-R/L-20-(0.5-1.8)	●	○	20	16	150	40	-	18.3	12	QC11R/L (0.50-1.80)	3008 M2.5x6	80-T08
AIKT-QC16-R/L-20-(0.5-1.8)	○	○	20	25	150	35	-	18.3	13.5	QC16R/L (0.50-1.80)		
AIKT-QC16-R/L-20-(0.5-2.5)	●	○	20	25	150	35	-	18.3	13.5	QC16R/L (0.50-2.50)	4015-M3.5x10	80-T15
AIKT-QC22-R/L-25-(1-2.3)	○	○	25	35	150	35	-	23	18.2	QC22R/L (1.00-2.30)		
AIKT-QC22-R/L-25-(2.5-3.3)	●	○	25	35	150	35	-	23	18.2	QC22R/L (2.50-3.30)	1120 M5x20	80-T20
AIKT-QC22-R/L-25-(3.3-4.8)	●	○	25	35	150	35	-	23	18.2	QC22R/L (3.30-4.80)		
AIKT-QC22-R/L-32-(1-2.3)	○	○	32	45	150	35	-	30	23.2	QC22R/L (1.00-2.30)		

R: Sağ / Right / Правый L: Sol/Left/Левый
● Stokta / In Stock / В наличии ○ Stokta Yok / Non Stock Item / Нет в наличии
ZCC Ucuna Uygun. / Compatible with ZCC Insert. / Под пластину ZCC

Sipariş Örneği/Ordering Example/Образец заказа
1 ad./pcs./шт AIKT-SGC-R-25-3-T6



Takım Kodu Ordering Code Код для заказа	Stok Stock Наличие	Takım Ölçüleri (mm) Dimension (mm) Размеры (мм)					Kesici Uç Insert Пластина	Yedek Parçaları / Spare Parts / Запасные части		
		d	d1	L	l	h		Sıkma Vidası Screw Зажимной Винт	Tork Anahtar Torx Key Торх Ключ	
AIKT-MB07-A16-090-15	●	16	7.4	90	15	14				
AIKT-MB07-A16-090-22	●	16	7.4	90	22	14				
AIKT-MB09-A16-090-19	●	16	9.5	90	19	14				
AIKT-MB09-A16-095-28	●	16	9.5	95	28	14				
AIKT-MB09-A16-110-40	●	16	9.5	110	40	14				

R: Sağ / Right / Правый L: Sol/Left/Левый

● Stokta / In Stock / В наличии ○ Stokta Yok / Non Stock Item / Нет в наличии

SNDVK Ucuna Uygunudur. / Compatiple with SNDVK Insert. / Под пластину SNDVK

Sipariş Örneği/Ordering Example/Образец заказа

1 ad./pcs./шт AIKT-MB07-A16-090-15



konusulan
the spoken **kalite...**
quality...





DELİK DELME ve İŞLEME TAKIMLARI
DRILLING and HOLEMAKING TOOLS
ИНСТРУМЕНТ ДЛЯ СВЕРЛЕНИЯ И ОБРАБОТКИ ОТВЕРСТИЙ





*konusulan
the spoken kalite...
quality...*

U-DRILL

TAKMA UÇLU MATKAPLAR
U-DRILL SYSTEM
СВЕРЛА





AKKO **A** **TUM** **16** x **D3**

S **P** **G** **T** **06** **02** **04**

2 Kesici Stili / Cutter Style
Тип режущего инструмента

TUM: Takma Uçlu Matkap
U-Drill
сверла

3 Takım Çapı / Tool Diameter
Диаметр Сверла

4 Delme Derinliği / Drilling Depth
Глубина сверления

D x 2
D x 3
D x 4

5 Uç Şekli / Insert Form
Форма пластины

W **S**

8 Uç Tipi / Insert Type
Форма пластины

A J T
 $\beta = 70-90^\circ$ $\beta = 70-90^\circ$ $\beta = 40-60^\circ$

B M U
 $\beta = 70-90^\circ$ $\beta = 40-60^\circ$ $\beta = 40-60^\circ$

C N W
 $\beta = 70-90^\circ$ $\beta = 40-60^\circ$ $\beta = 40-60^\circ$

F Q X
 $\beta = 70-90^\circ$ $\beta = 40-60^\circ$ Özel
Special
специальная

H R
 $\beta = 70-90^\circ$

10 Kalınlık / Thickness
Толщина

01 s = 1.59
T1 s = 1.98
02 s = 2.38
T2 s = 2.78
03 s = 3.18
T3 s = 3.97
04 s = 4.76
05 s = 5.56
06 s = 6.35
07 s = 7.94
09 s = 9.52

6 Serbest Uç Açısı / Clearance angle of Insert
Задний угол пластины

C **P**

7 Toleranslar / Tolerance Classes
Толерансы

	d	m	t
A	± 0.025	± 0.005	± 0.025
C	± 0.025	± 0.013	± 0.025
E	± 0.025	± 0.025	± 0.025
F	± 0.013	± 0.005	± 0.025
G	± 0.025	± 0.025	± 0.130
H	± 0.013	± 0.013	± 0.025
J	± 0.05-0.15	± 0.005	± 0.025
K	± 0.05-0.15	± 0.013	± 0.025
L	± 0.05-0.15	± 0.025	± 0.025
M	± 0.05-0.15	± 0.08-0.20	± 0.130
N	± 0.05-0.15	± 0.08-0.20	± 0.025
U	± 0.08-0.25	± 0.13-0.38	± 0.130

d : Daire Ölçüsü / Inscribed Circle / Вписанная окружность
m : Şekle Göre / Refer to Figure / Рисунок
t : Kalınlık / Thickness / Толщина

9 Kesme Kenar Uzunluğu / Cutting Edge Length
Длина режущей кромки

11 Köşe Konfigürasyonu / Corner Radius
Угловой радиус

01 r = 0.1
02 r = 0.2
04 r = 0.4
08 r = 0.8
12 r = 1.2
16 r = 1.6
24 r = 2.4



Delme Derinliği = 2xÇap
Drilling Depth = 2xDiameter
Глубина сверления = 2xДиаметр

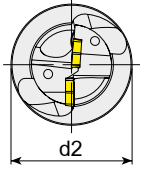
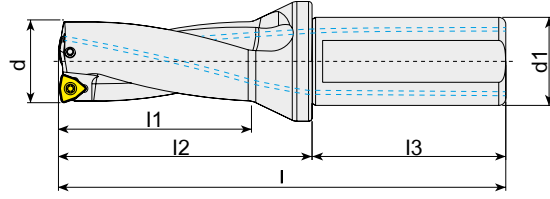

Takım Kodu Ordering Code Код для заказа	Stok Stock Наличие	Takım Ölçüleri (mm) Dimension (mm) Размеры (мм)							Kesici Uç Insert Пластина	Yedek Parçaları / Spare Parts / Запасные части				
		d	d1	d2	l	l1	l2	l3		Sıkma Vidası Screw Зажимной винт	Tork Anahtar Torx Key Торх Ключ			
ATUM 16XD2 WCM. 030208	●	16	25	34	110	32	54	56	WCM. 030208	3008-M2.5x6	80-T08			
ATUM 16.5XD2 WCM. 030208	●	16.5	25	34	110	32	54	56						
ATUM 17XD2 WCM. 030208	●	17	25	34	112	34	56	56						
ATUM 17.5XD2 WCM. 030208	●	17.5	25	34	112	34	56	56						
ATUM 18XD2 WCM. 030208	●	18	25	34	114	36	58	56						
ATUM 18.5XD2 WCM. 030208	●	18.5	25	34	114	36	58	56						
ATUM 19XD2 WCM. 030208	●	19	25	34	116	38	60	56						
ATUM 19.5XD2 WCM. 030208	●	19.5	25	34	116	38	60	56						
ATUM 20XD2 WCM. 040208	●	20	25	34	118	40	62	56				WCM. 040208	3008-M2.5x6	80-T08
ATUM 20.5XD2 WCM. 040208	●	20.5	25	34	118	40	62	56						
ATUM 21XD2 WCM. 040208	●	21	25	34	120	42	64	56						
ATUM 21.5XD2 WCM. 040208	●	21.5	25	34	120	42	64	56						
ATUM 22XD2 WCM. 040208	●	22	25	34	122	44	66	56						
ATUM 22.5XD2 WCM. 040208	●	22.5	25	34	122	44	66	56						
ATUM 23XD2 WCM. 040208	●	23	25	34	124	46	68	56						
ATUM 23.5XD2 WCM. 040208	●	23.5	25	34	124	46	68	56						
ATUM 24XD2 WCM. 050308	●	24	25	34	126	48	70	56	WCM. 050308	3008-M3x8	80-T08			
ATUM 24.5XD2 WCM. 050308	●	24.5	25	34	126	48	70	56						
ATUM 25XD2 WCM. 050308	●	25	25	34	128	50	72	56						
ATUM 25.5XD2 WCM. 050308	●	25.5	25	34	128	50	72	56						
ATUM 26XD2 WCM. 050308	●	26	25	34	130	52	74	56						
ATUM 26.5XD2 WCM. 050308	●	26.5	25	34	130	52	74	56						
ATUM 27XD2 WCM. 050308	●	27	25	34	132	54	76	56						
ATUM 27.5XD2 WCM. 050308	●	27.5	25	34	132	54	76	56						
ATUM 28XD2 WCM. 050308	●	28	25	34	134	56	78	56						
ATUM 28.5XD2 WCM. 050308	●	28.5	25	34	134	56	78	56						
ATUM 29XD2 WCM. 050308	●	29	25	34	136	58	80	56	WCM. 050308	3008-M3x8	80-T08			
ATUM 29.5XD2 WCM. 050308	●	29.5	25	34	136	58	80	56						

R: Sağ / Right / Правый L: Sol/Left/Левый

● Stokta / In Stock / В наличии ○ Stokta Yok / Non Stock Item / Нет в наличии

ISO Ucuna Uygundur. / Compatible with ISO Insert. / Под пластину ISO

Sipariş Örneği/Ordering Example/Образец заказа

1 ad./pcs./шт ATUM 16xD2 WCM. 030208

Takma Uçlu Matkap Kullanım Kılavuzu : S 319 / User's Guide For U-Drills : P 319

Руководство для эксплуатации сверел: стр. 320

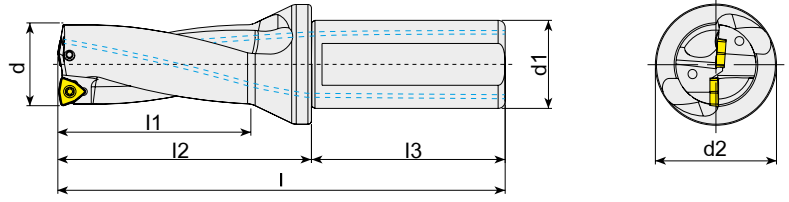

Delme Derinliđi = 2xÇap
Drilling Depth = 2xDiameter
Глубина сверления = 2xДиаметр

Takım Kodu
Ordering Code
Код для заказа

Stok
Stock
Наличие

Takım Ölçüleri (mm)
Dimension (mm)
Размеры (мм)

Kesici Uç
Insert
Пластина

Yedek Parçaları / Spare Parts / Запасные части

Sıkma Vidası
Screw
Зажимной Винт

Tork Anahtar
Torx Key
Торх Ключ

Takım Kodu Ordering Code Код для заказа	Stok Stock Наличие	d	d ₁	d ₂	l	l ₁	l ₂	l ₃	Kesici Uç Insert Пластина	Sıkma Vidası Screw Зажимной Винт	Tork Anahtar Torx Key Торх Ключ
ATUM 30XD2 WCM. 06T308	●	30	32	44	147	60	87	60	WCM. 06T308	3010-M3.5x9	80-T10
ATUM 31XD2 WCM. 06T308	●	31	32	44	149	62	89	60			
ATUM 32XD2 WCM. 06T308	●	32	32	44	151	64	91	60			
ATUM 33XD2 WCM. 06T308	●	33	32	44	153	66	93	60			
ATUM 34XD2 WCM. 06T308	●	34	32	44	155	68	95	60			
ATUM 35XD2 WCM. 06T308	●	35	32	44	157	70	97	60			
ATUM 36XD2 WCM. 06T308	●	36	32	44	159	72	99	60			
ATUM 37XD2 WCM. 06T308	●	37	32	44	161	74	101	60			
ATUM 38XD2 WCM. 06T308	●	38	32	44	163	76	103	60			
ATUM 39XD2 WCM. 06T308	●	39	32	44	165	78	105	60			
ATUM 40XD2 WCM. 06T308	●	40	32	44	167	80	107	60			
ATUM 41XD2 WCM. 06T308	●	41	32	44	169	82	109	60			
ATUM 42XD2 WCM. 06T308	●	42	32	44	171	84	111	60			
ATUM 43XD2 WCM. 06T308	●	43	32	44	173	86	113	60			
ATUM 44XD2 WCM. 06T308	●	44	32	44	175	88	115	60			
ATUM 45XD2 WCM. 080412	●	45	40	54	192	90	122	70			
ATUM 46XD2 WCM. 080412	●	46	40	54	194	92	124	70			
ATUM 47XD2 WCM. 080412	●	47	40	54	196	94	126	70			
ATUM 48XD2 WCM. 080412	●	48	40	54	198	96	128	70			
ATUM 49XD2 WCM. 080412	●	49	40	54	200	98	130	70			
ATUM 50XD2 WCM. 080412	●	50	40	54	202	100	132	70			
ATUM 51XD2 WCM. 080412	●	51	40	54	204	102	134	70			
ATUM 52XD2 WCM. 080412	●	52	40	54	206	104	136	70			
ATUM 53XD2 WCM. 080412	●	53	40	54	208	106	138	70			
ATUM 54XD2 WCM. 080412	●	54	40	54	210	108	140	70			
ATUM 55XD2 WCM. 080412	●	55	40	54	212	110	142	70			
ATUM 56XD2 WCM. 080412	●	56	40	64	214	112	144	70			
ATUM 57XD2 WCM. 080412	●	57	40	64	216	114	146	70			
ATUM 58XD2 WCM. 080412	●	58	40	64	218	116	148	70			
ATUM 59XD2 WCM. 080412	●	59	40	64	220	118	150	70			
ATUM 60XD2 WCM. 080412	●	60	40	64	222	120	152	70			

R: Sağ / Right / Правый L: Sol/Left/Левый

● Stokta / In Stock / В наличии ○ Stokta Yok / Non Stock Item / Нет в наличии

ISO Ucuna Uygunudur. / Compatiple with ISO Insert. / Под пластину ISO

Sipariş Örneđi/Ordering Example/Образец заказа

1 ad./pcs./шт ATUM 30xD2 WCM. 06T308

Takma Uçlu Matkap Kullanım Kılavuzu : S 319 / User's Guide For U-Drills : P 319 / Руководство для эксплуатации сверел: стр. 320



Delme Derinliği = 3xÇap
Drilling Depth = 3xDiameter
Глубина сверления = 3xДиаметр

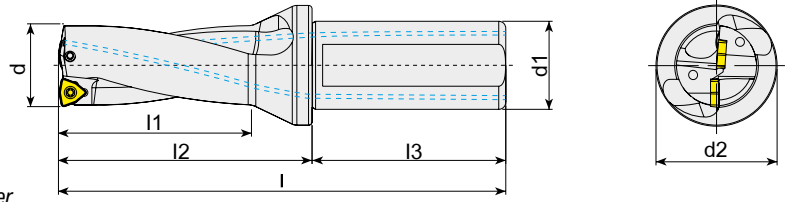

Takım Kodu Ordering Code Код для заказа	Stok Stock Наличие	Takım Ölçüleri (mm) Dimension (mm) Размеры (мм)							Kesici Uç Insert Пластина	Yedek Parçaları / Spare Parts / Залпасные части	
		d	d ₁	d ₂	l	l ₁	l ₂	l ₃		Sıkma Vidası Screw Зажимной винт	Tork Anahtar Torx Key Торх Ключ
ATUM 16XD3 WCM. 030208	●	16	25	34	126	48	70	56	WCM. 030208	3008-M2.5x6	80-T08
ATUM 16.5XD3 WCM. 030208	●	16.5	25	34	126	48	70	56			
ATUM 17XD3 WCM. 030208	●	17	25	34	129	51	73	56			
ATUM 17.5XD3 WCM. 030208	●	17.5	25	34	129	51	73	56			
ATUM 18XD3 WCM. 030208	●	18	25	34	132	54	76	56			
ATUM 18.5XD3 WCM. 030208	●	18.5	25	34	132	54	76	56			
ATUM 19XD3 WCM. 030208	●	19	25	34	135	57	79	56			
ATUM 19.5XD3 WCM. 030208	●	19.5	25	34	135	57	79	56			
ATUM 20XD3 WCM. 040208	●	20	25	34	138	60	82	56			
ATUM 20.5XD3 WCM. 040208	●	20.5	25	34	138	60	82	56			
ATUM 21XD3 WCM. 040208	●	21	25	34	141	63	85	56			
ATUM 21.5XD3 WCM. 040208	●	21.5	25	34	141	63	85	56			
ATUM 22XD3 WCM. 040208	●	22	25	34	144	66	88	56			
ATUM 22.5XD3 WCM. 040208	●	22.5	25	34	144	66	88	56			
ATUM 23XD3 WCM. 040208	●	23	25	34	147	69	91	56			
ATUM 23.5XD3 WCM. 040208	●	23.5	25	34	147	69	91	56			
ATUM 24XD3 WCM. 050308	●	24	25	34	150	72	94	56	WCM. 050308	3008-M3x8	80-T08
ATUM 24.5XD3 WCM. 050308	●	24.5	25	34	150	72	94	56			
ATUM 25XD3 WCM. 050308	●	25	25	34	153	75	97	56			
ATUM 25.5XD3 WCM. 050308	●	25.5	25	34	153	75	97	56			
ATUM 26XD3 WCM. 050308	●	26	25	34	156	78	100	56			
ATUM 26.5XD3 WCM. 050308	●	26.5	25	34	156	78	100	56			
ATUM 27XD3 WCM. 050308	●	27	25	34	159	81	103	56			
ATUM 27.5XD3 WCM. 050308	●	27.5	25	34	159	81	103	56			
ATUM 28XD3 WCM. 050308	●	28	25	34	162	84	106	56			
ATUM 28.5XD3 WCM. 050308	●	28.5	25	34	162	84	106	56			
ATUM 29XD3 WCM. 050308	●	29	25	34	165	87	109	56			
ATUM 29.5XD3 WCM. 050308	●	29.5	25	34	165	87	109	56			
ATUM 30XD3 WCM. 06T308	●	30	32	44	177	90	117	60			
ATUM 30.5XD3 WCM. 06T308	●	30.5	32	44	177	90	117	60			
ATUM 31XD3 WCM. 06T308	●	31	32	44	180	93	120	60			
ATUM 31.5XD3 WCM. 06T308	●	31.5	32	44	180	93	120	60			
ATUM 32XD3 WCM. 06T308	●	32	32	44	183	96	123	60			
ATUM 32.5XD3 WCM. 06T308	●	32.5	32	44	183	96	123	60			
ATUM 33XD3 WCM. 06T308	●	33	32	44	186	99	126	60			
ATUM 33.5XD3 WCM. 06T308	●	33.5	32	44	186	99	126	60			
ATUM 34XD3 WCM. 06T308	●	34	32	44	189	102	129	60			
ATUM 34.5XD3 WCM. 06T308	●	34.5	32	44	189	102	129	60			

R: Sağ / Right / Правый L: Sol/Left/Левый

● Stokta / In Stock / В наличии ○ Stokta Yok / Non Stock Item / Нет в наличии

ISO Uçuna Uygundur. / Compatible with ISO Insert. / Под пластину ISO

Sipariş Örneği/Ordering Example/Образец заказа

1 ad./pcs./шт ATUM 16xD3 WCM. 030208

Takma Uçlu Matkap Kullanım Kılavuzu : S 319 / User's Guide For U-Drills : P 319

Руководство для эксплуатации сверел: стр. 320



Delme Derinliği = 3xÇap
Drilling Depth = 3xDiameter
Глубина сверления = 3xДиаметр

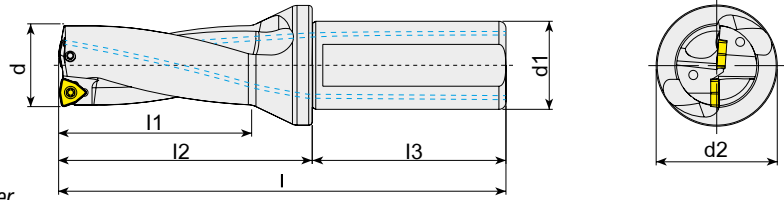

Takım Kodu
Ordering Code
Код для заказа

Stok
Stock
Наличие





Takım Ölçüleri (mm)
Dimension (mm)
Размеры (мм)

Kesici Uç
Insert
Пластина

Yedek Parçaları / Spare Parts / Запасные части

Sıkma Vidası
Screw
Зажимной винт

Tork Anahtar
Torx Key
Торх Ключ

Takım Kodu Ordering Code Код для заказа	Stok Stock Наличие	Takım Ölçüleri (mm) Dimension (mm) Размеры (мм)							Kesici Uç Insert Пластина	Yedek Parçaları / Spare Parts / Запасные части		
		d	d ₁	d ₂	l	l ₁	l ₂	l ₃		Sıkma Vidası Screw Зажимной винт	Tork Anahtar Torx Key Торх Ключ	
ATUM 35XD3 WCM. 06T308	●	35	32	44	192	105	132	60			3010-M3.5x9	80-T10
ATUM 35.5XD3 WCM. 06T308	●	35.5	32	44	192	105	132	60				
ATUM 36XD3 WCM. 06T308	●	36	32	44	195	108	135	60				
ATUM 36.5XD3 WCM. 06T308	●	36.5	32	44	195	108	135	60				
ATUM 37XD3 WCM. 06T308	●	37	32	44	198	111	138	60				
ATUM 37.5XD3 WCM. 06T308	●	37.5	32	44	198	111	138	60				
ATUM 38XD3 WCM. 06T308	●	38	32	44	201	114	141	60				
ATUM 38.5XD3 WCM. 06T308	●	38.5	32	44	201	114	141	60				
ATUM 39XD3 WCM. 06T308	●	39	32	44	204	117	144	60				
ATUM 39.5XD3 WCM. 06T308	●	39.5	32	44	204	117	144	60				
ATUM 40XD3 WCM. 06T308	●	40	32	44	207	120	147	60				
ATUM 40.5XD3 WCM. 06T308	●	40.5	32	44	207	120	147	60				
ATUM 41XD3 WCM. 06T308	●	41	32	44	210	123	150	60				
ATUM 41.5XD3 WCM. 06T308	●	41.5	32	44	210	123	150	60				
ATUM 42XD3 WCM. 06T308	●	42	32	44	213	126	153	60				
ATUM 42.5XD3 WCM. 06T308	●	42.5	32	44	213	126	153	60				
ATUM 43XD3 WCM. 06T308	●	43	32	44	216	129	156	60				
ATUM 43.5XD3 WCM. 06T308	●	43.5	32	44	216	129	156	60				
ATUM 44XD3 WCM. 06T308	●	44	32	44	219	132	159	60				
ATUM 44.5XD3 WCM. 06T308	●	44.5	32	44	219	132	159	60				
ATUM 45XD3 WCM. 080412	●	45	40	54	237	135	167	70			4015-M4x11	80-T15
ATUM 45.5XD3 WCM. 080412	●	45.5	40	54	237	135	167	70				
ATUM 46XD3 WCM. 080412	●	46	40	54	240	138	170	70				
ATUM 47XD3 WCM. 080412	●	47	40	54	243	141	173	70				
ATUM 48XD3 WCM. 080412	●	48	40	54	246	144	176	70				
ATUM 49XD3 WCM. 080412	●	49	40	54	249	147	179	70				
ATUM 50XD3 WCM. 080412	●	50	40	54	252	150	182	70				
ATUM 51XD3 WCM. 080412	●	51	40	54	255	153	185	70				
ATUM 52XD3 WCM. 080412	●	52	40	54	258	156	188	70				
ATUM 53XD3 WCM. 080412	●	53	40	54	261	159	191	70				
ATUM 54XD3 WCM. 080412	●	54	40	54	264	162	194	70				
ATUM 55XD3 WCM. 080412	●	55	40	54	267	165	197	70				
ATUM 56XD3 WCM. 080412	●	56	40	64	270	168	200	70				
ATUM 57XD3 WCM. 080412	●	57	40	64	273	171	203	70				
ATUM 58XD3 WCM. 080412	●	58	40	64	276	174	206	70				
ATUM 59XD3 WCM. 080412	●	59	40	64	279	177	209	70				
ATUM 60XD3 WCM. 080412	●	60	40	64	282	180	212	70				

R: Sağ / Right / Правый L: Sol/Left/Левый
● Stokta / In Stock / В наличии ○ Stokta Yok / Non Stock Item / Нет в наличии
ISO Uçuna Uygundur. / Compatible with ISO Insert. / Под пластину ISO

Sipariş Örneği/Ordering Example/Образец заказа
1 ad./pcs./шт ATUM 35xD3 WCM. 06T308
Takma Uçlu Matkap Kullanım Kılavuzu : S 319 / User's Guide For U-Drills : P 319
Руководство для эксплуатации сверел: стр. 320



Delme Derinliği = 4xÇap
Drilling Depth = 4xDiameter
Глубина сверления = 4xДиаметр

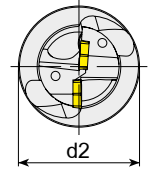
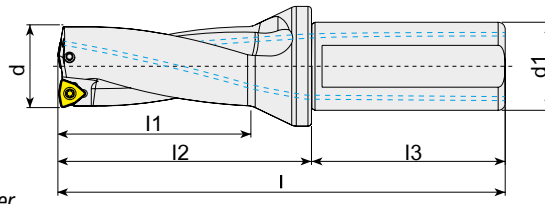

Takım Kodu Ordering Code Код для заказа	Stok Stock Наличие	Takım Ölçüleri (mm) Dimension (mm) Размеры (мм)							Kesici Uç Insert Пластина	Yedek Parçaları / Spare Parts / Запасные части	
		d	d ₁	d ₂	l	l ₁	l ₂	l ₃		Sıkma Vidası Screw Зажимной винт	Tork Anahtar Torx Key Торх Ключ
ATUM 16XD4 WCM. 030208	●	16	25	34	142	64	86	56	WCM. 030208		
ATUM 16.5XD4 WCM. 030208	○	16.5	25	34	142	64	86	56			
ATUM 17XD4 WCM. 030208	●	17	25	34	146	68	90	56			
ATUM 17.5XD4 WCM. 030208	○	17.5	25	34	146	68	90	56			
ATUM 18XD4 WCM. 030208	●	18	25	34	150	72	94	56			
ATUM 18.5XD4 WCM. 030208	○	18.5	25	34	150	72	94	56			
ATUM 19XD4 WCM. 030208	●	19	25	34	154	76	98	56			
ATUM 19.5XD4 WCM. 030208	○	19.5	25	34	154	76	98	56			
ATUM 20XD4 WCM. 040208	●	20	25	34	158	80	102	56	WCM. 040208	3008-M2.5x6	80-T08
ATUM 20.5XD4 WCM. 040208	○	20.5	25	34	158	80	102	56			
ATUM 21XD4 WCM. 040208	●	21	25	34	162	84	106	56			
ATUM 21.5XD4 WCM. 040208	○	21.5	25	34	162	84	106	56			
ATUM 22XD4 WCM. 040208	●	22	25	34	166	88	110	56			
ATUM 22.5XD4 WCM. 040208	●	22.5	25	34	166	88	110	56			
ATUM 23XD4 WCM. 040208	●	23	25	34	170	92	114	56			
ATUM 23.5XD4 WCM. 040208	○	23.5	25	34	170	92	114	56			
ATUM 24XD4 WCM. 050308	●	24	25	34	174	96	118	56	WCM. 050308	3008-M3x8	
ATUM 24.5XD4 WCM. 050308	○	24.5	25	34	174	96	118	56			
ATUM 25XD4 WCM. 050308	●	25	25	34	178	100	122	56			
ATUM 25.5XD4 WCM. 050308	○	25.5	25	34	178	100	122	56			
ATUM 26XD4 WCM. 050308	●	26	25	34	182	104	126	56			
ATUM 26.5XD4 WCM. 050308	●	26.5	25	34	182	104	126	56			
ATUM 27XD4 WCM. 050308	●	27	25	34	186	108	130	56			
ATUM 27.5XD4 WCM. 050308	○	27.5	25	34	186	108	130	56			
ATUM 28XD4 WCM. 050308	●	28	25	34	190	112	134	56			
ATUM 28.5XD4 WCM. 050308	●	28.5	25	34	190	112	134	56			
ATUM 29XD4 WCM. 050308	●	29	25	34	194	116	138	56			
ATUM 29.5XD4 WCM. 050308	○	29.5	25	34	194	116	138	56			

R: Sağ / Right / Правый L: Sol/Left/Левый

● Stokta / In Stock / В наличии ○ Stokta Yok / Non Stock Item / Нет в наличии
ISO Ucuna Uygundur. / Compatible with ISO Insert. / Под пластину ISO

Sipariş Örneği/Ordering Example/Образец заказа

1 ad./pcs./шт ATUM 16xD4 WCM. 030208

Takma Uçlu Matkap Kullanım Kılavuzu : S 319 / User's Guide For U-Drills : P 319

Руководство для эксплуатации сверел: стр. 320



Delme Derinliği = 4xÇap
Drilling Depth = 4xDiameter
Глубина сверления = 4xДиаметр

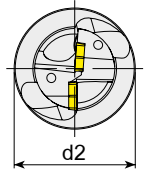
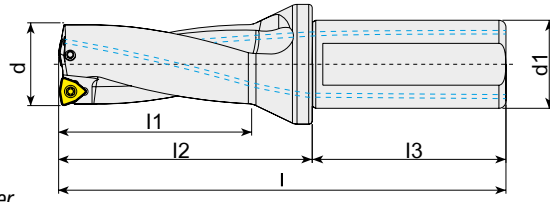

Takım Kodu Ordering Code Код для заказа	Stok Stock Наличие	Takım Ölçüleri (mm) Dimension (mm) Размеры (мм)							Kesici Uç Insert Пластина	Yedek Parçaları / Spare Parts / Запасные части		
		d	d ₁	d ₂	l	l ₁	l ₂	l ₃		Sıkma Vidası Screw Зажимной винт	Tork Anahtar Torx Key Торх Ключ	
ATUM 30XD4 WCM. 06T308	●	30	32	44	207	120	147	60	WCM. 06T308	3010-M3.5x9	80-T10	
ATUM 31XD4 WCM. 06T308	●	31	32	44	211	124	151	60				
ATUM 32XD4 WCM. 06T308	●	32	32	44	215	128	155	60				
ATUM 33XD4 WCM. 06T308	●	33	32	44	219	132	159	60				
ATUM 33.5XD4 WCM. 06T308	●	33.5	32	44	219	132	159	60				
ATUM 34XD4 WCM. 06T308	●	34	32	44	223	136	163	60				
ATUM 35XD4 WCM. 06T308	●	35	32	44	227	140	167	60				
ATUM 36XD4 WCM. 06T308	●	36	32	44	231	144	171	60				
ATUM 37XD4 WCM. 06T308	●	37	32	44	235	148	175	60				
ATUM 38XD4 WCM. 06T308	●	38	32	44	239	152	179	60				
ATUM 38.5XD4 WCM. 06T308	●	38.5	32	44	239	152	179	60				
ATUM 39XD4 WCM. 06T308	●	39	32	44	243	156	183	60				
ATUM 40XD4 WCM. 06T308	●	40	32	44	247	160	187	60				
ATUM 41XD4 WCM. 06T308	●	41	32	44	251	164	191	60				
ATUM 42XD4 WCM. 06T308	●	42	32	44	255	168	195	60				
ATUM 43XD4 WCM. 06T308	●	43	32	44	259	172	199	60				
ATUM 44XD4 WCM. 06T308	●	44	32	44	263	176	203	60				
ATUM 45XD4 WCM. 080412	●	45	40	54	282	180	212	70	WCM. 080412	4015-M4x11	80-T15	
ATUM 46XD4 WCM. 080412	●	46	40	54	286	184	216	70				
ATUM 47XD4 WCM. 080412	●	47	40	54	290	188	220	70				
ATUM 48XD4 WCM. 080412	●	48	40	54	294	192	224	70				
ATUM 49XD4 WCM. 080412	●	49	40	54	298	196	228	70				
ATUM 50XD4 WCM. 080412	●	50	40	54	302	200	232	70				

R: Sağ / Right / Правый L: Sol/Left/Левый
● Stokta / In Stock / В наличии ○ Stokta Yok / Non Stock Item / Нет в наличии
ISO Uçuna Uygundur. / Compatible with ISO Insert. / Под пластину ISO

Sipariş Örneği/Ordering Example/Образец заказа
1 ad./pcs./шт ATUM 30xD4 WCM. 06T308
Takma Uçlu Matkap Kullanım Kılavuzu : S 319 / User's Guide For U-Drills : P 319
Руководство для эксплуатации сверел: стр. 320





Delme Derinliği = 2xÇap
Drilling Depth = 2xDiameter
Глубина сверления = 2xДиаметр

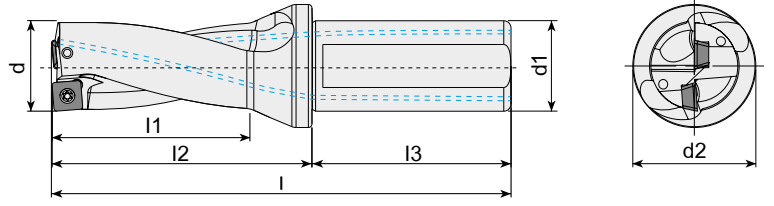

Takım Kodu Ordering Code Код для заказа	Stok Stock Наличие	Takım Ölçüleri (mm) Dimension (mm) Размеры (мм)							Kesici Uç Insert Пластина	Yedek Parçaları / Spare Parts / Запасные части	
		d	d1	d2	l	l1	l2	l3		Sıkma Vidası Screw Зажимной винт	Tork Anahtar Torx Key Торх Ключ
ATUM 12.5XD2 SP.. 050204	●	12.5	20	25	96	24	46	50	SP.. 050204	3006-M2x4	80-T06
ATUM 13XD2 SP.. 050204	●	13	20	25	98	26	48	50			
ATUM 13.5XD2 SP.. 050204	●	13.5	20	25	98	26	48	50			
ATUM 14XD2 SP.. 050204	●	14	20	25	100	28	50	50			
ATUM 14.5XD2 SP.. 050204	●	14.5	20	25	100	28	50	50			
ATUM 15XD2 SP.. 050204	●	15	20	25	102	30	52	50			
ATUM 15.5XD2 SP.. 060204	●	15.5	20	25	102	30	52	50	SP.. 060204	3007-M2.2x5	80-T07
ATUM 16XD2 SP.. 060204	●	16	25	34	110	32	54	56			
ATUM 16.5XD2 SP.. 060204	●	16.5	25	34	110	32	54	56			
ATUM 17XD2 SP.. 060204	●	17	25	34	112	34	56	56			
ATUM 17.5XD2 SP.. 060204	●	17.5	25	34	112	34	56	56			
ATUM 18XD2 SP.. 060204	●	18	25	34	114	36	58	56			
ATUM 18.5D2 SP.. 060204	●	18.5	25	34	114	36	58	56			
ATUM 19XD2 SP.. 060204	●	19	25	34	116	38	60	56			
ATUM 19.5XD2 SP.. 060204	●	19.5	25	34	116	38	60	56			
ATUM 20XD2 SP.. 060204	●	20	25	34	118	40	62	56			
ATUM 20.5XD2 SP.. 060204	●	20.5	25	34	118	40	62	56			
ATUM 21XD2 SP.. 060204	●	21	25	34	120	42	64	56			
ATUM 21.5XD2 SP.. 060204	●	21.5	25	34	120	42	64	56			
ATUM 22XD2 SP.. 07T308	●	22	25	34	122	44	66	56			
ATUM 22.5XD2 SP.. 07T308	●	22.5	25	34	122	44	66	56			
ATUM 23XD2 SP.. 07T308	●	23	25	34	124	46	68	56			
ATUM 23.5XD2 SP.. 07T308	●	23.5	25	34	124	46	68	56			
ATUM 24XD2 SP.. 07T308	●	24	25	34	126	48	70	56			
ATUM 24.5XD2 SP.. 07T308	●	24.5	25	34	126	48	70	56			
ATUM 25XD2 SP.. 07T308	●	25	25	34	128	50	72	56			
ATUM 25.5XD2 SP.. 07T308	●	25.5	25	34	128	50	72	56			
ATUM 26XD2 SP.. 07T308	●	26	25	34	130	52	74	56			
ATUM 26.5XD2 SP.. 07T308	●	26.5	25	34	130	52	74	56			
ATUM 27XD2 SP.. 07T308	●	27	25	34	132	54	76	56			
ATUM 27.5XD2 SP.. 07T308	●	27.5	25	34	132	54	76	56			

R: Sağ / Right / Правый L: Sol/Left/Левый
● Stokta / In Stock / В наличии ○ Stokta Yok / Non Stock Item / Нет в наличии
TGTC Ucuna Uygunudur. / Compatible with TGTC Insert. / Под пластину TGTC

Sipariş Örneği/Ordering Example/Образец заказа
1 ad./pcs./шт ATUM 12.5xD2 SP.. 050204
Takma Uçlu Matkap Kullanım Kılavuzu : S 319 / User's Guide For U-Drills : P 319
Руководство для эксплуатации сверел: стр. 320



Delme Derinliği = 2xÇap
Drilling Depth = 2xDiameter
Глубина сверления = 2xДиаметр

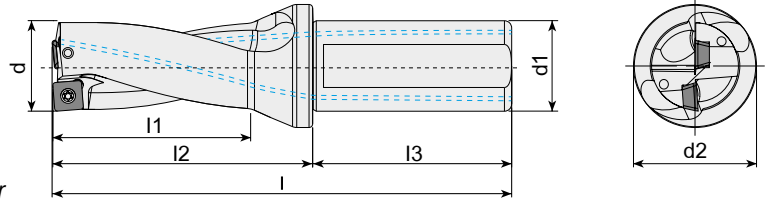

Takım Kodu Ordering Code Код для заказа	Stok Stock Наличие	Takım Ölçüleri (mm) Dimension (mm) Размеры (мм)							Kesici Uç Insert Пластина	Yedek Parçaları / Spare Parts / Запасные части	
		d	d ₁	d ₂	l	l ₁	l ₂	l ₃		Sıkma Vidası Screw Зажимной винт	Tork Anahtar Torx Key Торх Ключ
ATUM 28XD2 SP.. 090408	●	28	25	34	134	56	78	56	SP.. 090408	4015-M3.5x9	80-T15
ATUM 28.5XD2 SP.. 090408	●	28.5	25	34	134	56	78	56			
ATUM 29XD2 SP.. 090408	●	29	25	34	136	58	80	56			
ATUM 29.5XD2 SP.. 090408	●	29.5	25	34	136	58	80	56			
ATUM 30XD2 SP.. 090408	●	30	32	44	147	60	87	60			
ATUM 31XD2 SP.. 090408	●	31	32	44	149	62	89	60			
ATUM 32XD2 SP.. 090408	●	32	32	44	151	64	91	60			
ATUM 33XD2 SP.. 090408	●	33	32	44	153	66	93	60			
ATUM 34XD2 SP.. 110408	●	34	32	44	155	68	95	60			
ATUM 35XD2 SP.. 110408	●	35	32	44	157	70	97	60			
ATUM 36XD2 SP.. 110408	●	36	32	44	159	72	99	60			
ATUM 37XD2 SP.. 110408	●	37	32	44	161	74	101	60			
ATUM 38XD2 SP.. 110408	●	38	32	44	163	76	103	60			
ATUM 39XD2 SP.. 110408	●	39	32	44	165	78	105	60			
ATUM 40XD2 SP.. 110408	●	40	32	44	167	80	107	60			
ATUM 41XD2 SP.. 110408	●	41	32	44	169	82	109	60	SP.. 140512	1020-M5x11	80-T20
ATUM 42XD2 SP.. 140512	●	42	32	44	171	84	111	60			
ATUM 43XD2 SP.. 140512	●	43	32	44	173	86	113	60			
ATUM 44XD2 SP.. 140512	●	44	32	44	175	88	115	60			
ATUM 45XD2 SP.. 140512	●	45	40	54	192	90	122	70			
ATUM 46XD2 SP.. 140512	●	46	40	54	194	92	124	70			
ATUM 47XD2 SP.. 140512	●	47	40	54	196	94	126	70			
ATUM 48XD2 SP.. 140512	●	48	40	54	198	96	128	70			
ATUM 49XD2 SP.. 140512	●	49	40	54	200	98	130	70			
ATUM 50XD2 SP.. 140512	●	50	40	54	202	100	132	70			

R: Sağ / Right / Правый L: Sol/Left/Левый

● Stokta / In Stock / В наличии ○ Stokta Yok / Non Stock Item / Нет в наличии
TGTC Ucuna Uygundur. / Compatible with TGTC Insert. / Под пластину TGTC

Sipariş Örneği/Ordering Example/Образец заказа

1 ad./pcs./шт ATUM 28xD2 SP.. 090408

Takma Uçlu Matkap Kullanım Kılavuzu : S 319 / User's Guide For U-Drills : P 319

Руководство для эксплуатации сверел: стр. 320



Delme Derinliği = 3xÇap
Drilling Depth = 3xDiameter
Глубина сверления = 3xДиаметр

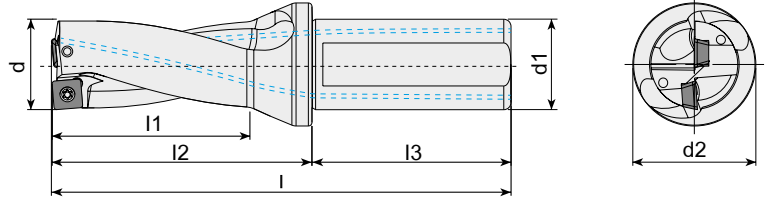

Takım Kodu
Ordering Code
Код для заказа

Stok
Stock
Наличие

Takım Ölçüleri (mm)
Dimension (mm)
Размеры (мм)

Kesici Uç
Insert
Пластина

Yedek Parçaları / Spare Parts / Запасные части

Sıkma Vidası
Screw
Зажимной винт

Tork Anahtar
Torx Key
Торх Ключ

Takım Kodu Ordering Code Код для заказа	Stok Stock Наличие	Takım Ölçüleri (mm) Dimension (mm) Размеры (мм)							Kesici Uç Insert Пластина	Sıkma Vidası Screw Зажимной винт	Tork Anahtar Torx Key Торх Ключ
		d	d1	d2	l	l1	l2	l3			
ATUM 12.5XD3 SP.. 050204	●	12.5	20	25	108	36	58	50	SP.. 050204	3006-M2x4	80-T06
ATUM 13XD3 SP.. 050204	●	13	20	25	111	39	61	50			
ATUM 13.5XD3 SP.. 050204	●	13.5	20	25	111	39	61	50			
ATUM 14XD3 SP.. 050204	●	14	20	25	114	42	64	50			
ATUM 14.5XD3 SP.. 050204	●	14.5	20	25	114	42	64	50			
ATUM 15XD3 SP.. 050204	●	15	20	25	117	45	67	50	SP.. 060204	3007-M2.2x5	80-T07
ATUM 15.5XD3 SP.. 060204	●	15.5	20	25	117	45	67	50			
ATUM 16XD3 SP.. 060204	●	16	25	34	126	48	70	56			
ATUM 16.5XD3 SP.. 060204	●	16.5	25	34	126	48	70	56			
ATUM 17XD3 SP.. 060204	●	17	25	34	129	51	73	56			
ATUM 17.5XD3 SP.. 060204	●	17.5	25	34	129	51	73	56			
ATUM 18XD3 SP.. 060204	●	18	25	34	132	54	76	56			
ATUM 18.5XD3 SP.. 060204	●	18.5	25	34	132	54	76	56			
ATUM 19XD3 SP.. 060204	●	19	25	34	135	57	79	56			
ATUM 19.5XD3 SP.. 060204	●	19.5	25	34	135	57	79	56			
ATUM 20XD3 SP.. 060204	●	20	25	34	138	60	82	56	SP.. 07T308	3008-M2.5x6	80-T08
ATUM 20.5XD3 SP.. 060204	●	20.5	25	34	138	60	82	56			
ATUM 21XD3 SP.. 060204	●	21	25	34	141	63	85	56			
ATUM 21.5XD3 SP.. 060204	●	21.5	25	34	141	63	85	56			
ATUM 22XD3 SP.. 07T308	●	22	25	34	144	66	88	56			
ATUM 22.5XD3 SP.. 07T308	●	22.5	25	34	144	66	88	56			
ATUM 23XD3 SP.. 07T308	●	23	25	34	147	69	91	56			
ATUM 23.5XD3 SP.. 07T308	●	23.5	25	34	147	69	91	56			
ATUM 24XD3 SP.. 07T308	●	24	25	34	150	72	94	56			
ATUM 24.5XD3 SP.. 07T308	●	24.5	25	34	150	72	94	56			
ATUM 25XD3 SP.. 07T308	●	25	25	34	153	75	97	56	SP.. 090408	4015-M3.5x9	80-T15
ATUM 25.5XD3 SP.. 07T308	●	25.5	25	34	153	75	97	56			
ATUM 26XD3 SP.. 07T308	●	26	25	34	156	78	100	56			
ATUM 26.5XD3 SP.. 07T308	●	26.5	25	34	156	78	100	56			
ATUM 27XD3 SP.. 07T308	●	27	25	34	159	81	103	56			
ATUM 27.5XD3 SP.. 07T308	●	27.5	25	34	159	81	103	56			
ATUM 28XD3 SP.. 090408	●	28	25	34	162	84	106	56			
ATUM 28.5XD3 SP.. 090408	●	28.5	25	34	162	84	106	56			
ATUM 29XD3 SP.. 090408	●	29	25	34	165	87	109	56			
ATUM 29.5XD3 SP.. 090408	●	29.5	25	34	165	87	109	56			
ATUM 30XD3 SP.. 090408	●	30	32	44	177	90	117	60			
ATUM 30.5XD3 SP.. 090408	●	30.5	32	44	177	90	117	60			
ATUM 31XD3 SP.. 090408	●	31	32	44	180	93	120	60			
ATUM 31.5XD3 SP.. 090408	●	31.5	32	44	180	93	120	60			
ATUM 32XD3 SP.. 090408	●	32	32	44	183	96	123	60			
ATUM 32.5XD3 SP.. 090408	●	32.5	32	44	183	96	123	60			
ATUM 33XD3 SP.. 090408	●	33	32	44	186	99	126	60			
ATUM 33.5XD3 SP.. 090408	●	33.5	32	44	186	99	126	60			

R: Sağ / Right / Правый L: Sol/Left/Левый

● Stokta / In Stock / В наличии ○ Stokta Yok / Non Stock Item / Нет в наличии
TGTC Ucuna Uygundur. / Compatible with TGTC Insert. / Под пластину TGTC



www.akkо.com.tr

Sipariş Örneği/Ordering Example/Образец заказа
1 ad./pcs./шт ATUM 12.5xD3 SP.. 050204

Takma Uçlu Matkap Kullanım Kılavuzu : S 319 / User's Guide For U-Drills : P 319
Руководство для эксплуатации сверел: стр. 320



Delme Derinliği = 3xÇap
Drilling Depth = 3xDiameter
Глубина сверления = 3xДиаметр

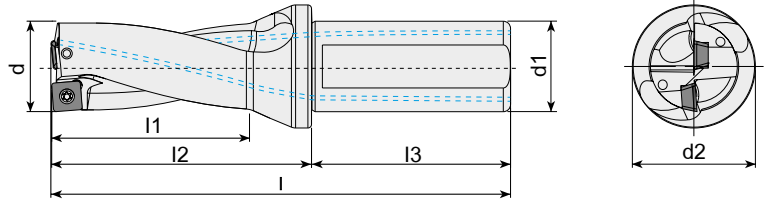

Takım Kodu Ordering Code Код для заказа	Stok Stock Наличие	Takım Ölçüleri (mm) Dimension (mm) Размеры (мм)							Kesici Uç Insert Пластина	Yedek Parçaları / Spare Parts / Запасные части	
		d	d ₁	d ₂	l	l ₁	l ₂	l ₃		Sıkma Vidası Screw Зажимной винт	Tork Anahtar Torx Key Торх Ключ
ATUM 34XD3 SP.. 110408	●	34	32	44	189	102	129	60	SP.. 110408	4015-M4x11	80-T15
ATUM 34.5XD3 SP.. 110408	●	34.5	32	44	189	102	129	60			
ATUM 35XD3 SP.. 110408	●	35	32	44	192	105	132	60			
ATUM 35.5XD3 SP.. 110408	●	35.5	32	44	192	105	132	60			
ATUM 36XD3 SP.. 110408	●	36	32	44	195	108	135	60			
ATUM 36.5XD3 SP.. 110408	●	36.5	32	44	195	108	135	60			
ATUM 37XD3 SP.. 110408	●	37	32	44	198	111	138	60			
ATUM 37.5XD3 SP.. 110408	●	37.5	32	44	198	111	138	60			
ATUM 38XD3 SP.. 110408	●	38	32	44	201	114	141	60			
ATUM 38.5XD3 SP.. 110408	●	38.5	32	44	201	114	141	60			
ATUM 39XD3 SP.. 110408	●	39	32	44	204	117	144	60			
ATUM 39.5XD3 SP.. 110408	●	39.5	32	44	204	117	144	60			
ATUM 40XD3 SP.. 110408	●	40	32	44	207	120	147	60			
ATUM 40.5XD3 SP.. 110408	●	40.5	32	44	207	120	147	60			
ATUM 41XD3 SP.. 110408	●	41	32	44	210	123	150	60			
ATUM 41.5XD3 SP.. 110408	●	41.5	32	44	210	123	150	60			
ATUM 42XD3 SP.. 140512	●	42	32	44	213	126	153	60			
ATUM 42.5XD3 SP.. 140512	●	42.5	32	44	213	126	153	60			
ATUM 43XD3 SP.. 140512	●	43	32	44	216	129	156	60			
ATUM 43.5XD3 SP.. 140512	●	43.5	32	44	216	129	156	60			
ATUM 44XD3 SP.. 140512	●	44	32	44	219	132	159	60			
ATUM 44.5XD3 SP.. 140512	●	44.5	32	44	219	132	159	60			
ATUM 45XD3 SP.. 140512	●	45	40	54	237	135	167	70			
ATUM 45.5XD3 SP.. 140512	●	45.5	40	54	237	135	167	70			
ATUM 46XD3 SP.. 140512	●	46	40	54	240	138	170	70			
ATUM 47XD3 SP.. 140512	●	47	40	54	243	141	173	70			
ATUM 48XD3 SP.. 140512	●	48	40	54	246	144	176	70			
ATUM 49XD3 SP.. 140512	●	49	40	54	249	147	179	70			
ATUM 50XD3 SP.. 140512	●	50	40	54	252	150	182	70			
ATUM 51XD3 SP.. 140512	●	51	40	54	255	153	185	70			
ATUM 52XD3 SP.. 140512	●	52	40	54	258	156	188	70			

R: Sağ / Right / Правый L: Sol/Left/Левый

● Stokta / In Stock / В наличии ○ Stokta Yok / Non Stock Item / Нет в наличии
TGTC Ucuna Uygundur. / Compatible with TGTC Insert. / Под пластину TGTC

Sipariş Örneği/Ordering Example/Образец заказа

1 ad./pcs./шт ATUM 34xD3 SP.. 110408

Takma Uçlu Matkap Kullanım Kılavuzu : S 319 / User's Guide For U-Drills : P 319

Руководство для эксплуатации сверел: стр. 320



Delme Derinliği = 4xÇap
Drilling Depth = 4xDiameter
Глубина сверления = 4xДиаметр

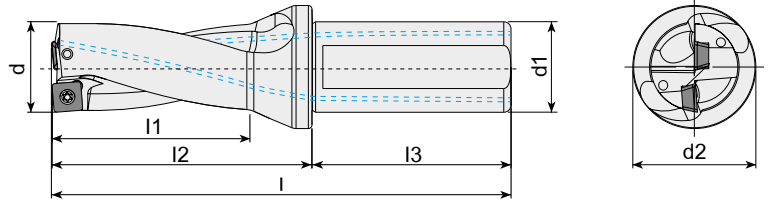

Takım Kodu Ordering Code Код для заказа	Stok Stock Наличие	Takım Ölçüleri (mm) Dimension (mm) Размеры (мм)							Kesici Uç Insert Пластина	Yedek Parçaları / Spare Parts / Запасные части	
		d	d1	d2	l	l1	l2	l3		Sıkma Vidası Screw Зажимной винт	Tork Anahtar Torx Key Торх Ключ
ATUM 13XD4 SP.. 050204	●	13	20	25	124	52	74	50	SP.. 050204	3006-M2x4	80-T06
ATUM 14XD4 SP.. 050204	●	14	20	25	128	56	78	50			
ATUM 15XD4 SP.. 050204	●	15	20	25	132	60	82	50			
ATUM 16XD4 SP.. 060204	●	16	25	34	142	64	86	56			
ATUM 17XD4 SP.. 060204	●	17	25	34	146	68	90	56	SP.. 060204	3007-M2.2x5	80-T07
ATUM 17.5XD4 SP.. 060204	●	17	25	34	146	68	90	56			
ATUM 18XD4 SP.. 060204	●	18	25	34	150	72	94	56			
ATUM 19XD4 SP.. 060204	●	19	25	34	154	76	98	56			
ATUM 19.5XD4 SP.. 060204	●	19.5	25	34	154	76	98	56			
ATUM 20XD4 SP.. 060204	●	20	25	34	158	80	102	56			
ATUM 21XD4 SP.. 060204	●	21	25	34	162	84	106	56			
ATUM 22XD4 SP.. 07T308	●	22	25	34	166	88	110	56	SP.. 07T308	3008-M2.5x6	80-T08
ATUM 23XD4 SP.. 07T308	●	23	25	34	170	92	114	56			
ATUM 23.5XD4 SP.. 07T308	●	23.5	25	34	170	92	114	56			
ATUM 24XD4 SP.. 07T308	●	24	25	34	174	96	118	56			
ATUM 25XD4 SP.. 07T308	●	25	25	34	178	100	122	56			
ATUM 26XD4 SP.. 07T308	●	26	25	34	182	104	126	56			
ATUM 27XD4 SP.. 07T308	●	27	25	34	186	108	130	56			
ATUM 27.5XD4 SP.. 07T308	●	27.5	25	34	186	108	130	56	SP.. 090408	4015-M3.5x9	80-T15
ATUM 28XD4 SP.. 090408	●	28	25	34	190	112	134	56			
ATUM 29XD4 SP.. 090408	●	29	25	34	194	116	138	56			
ATUM 30XD4 SP.. 090408	●	30	32	44	207	120	147	60			
ATUM 31XD4 SP.. 090408	●	31	32	44	211	124	151	60			
ATUM 32XD4 SP.. 090408	●	32	32	44	215	128	155	60			
ATUM 33XD4 SP.. 090408	●	33	32	44	219	132	159	60			
ATUM 33.5XD4 SP.. 090408	●	33.5	32	44	219	132	159	60	SP.. 110408	4015-M4x11	80-T15
ATUM 34XD4 SP.. 110408	●	34	32	44	223	136	163	60			
ATUM 35XD4 SP.. 110408	●	35	32	44	227	140	167	60			
ATUM 36XD4 SP.. 110408	●	36	32	44	231	144	171	60			
ATUM 37XD4 SP.. 110408	●	37	32	44	235	148	175	60			
ATUM 38XD4 SP.. 110408	●	38	32	44	239	152	179	60			
ATUM 39XD4 SP.. 110408	●	39	32	44	243	156	183	60			
ATUM 40XD4 SP.. 110408	●	40	32	44	247	160	187	60	SP.. 140512	1020-M5x11	80-T20
ATUM 41XD4 SP.. 110408	●	41	32	44	251	164	191	60			
ATUM 42XD4 SP.. 140512	●	42	32	44	255	168	195	60			
ATUM 43XD4 SP.. 140512	●	43	32	44	259	172	199	60			
ATUM 44XD4 SP.. 140512	●	44	32	44	263	176	203	60			

R: Sağ / Right / Правый L: Sol/Left/Левый
● Stokta / In Stock / В наличии ○ Stokta Yok / Non Stock Item / Нет в наличии
TGTC Ucuna Uygunudur. / Compatible with TGTC Insert. / Под пластину TGTC



Delme Derinliği = 2xÇap
Drilling Depth = 2xDiameter
Глубина сверления = 2xДиаметр

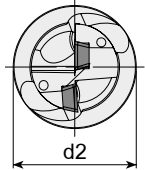
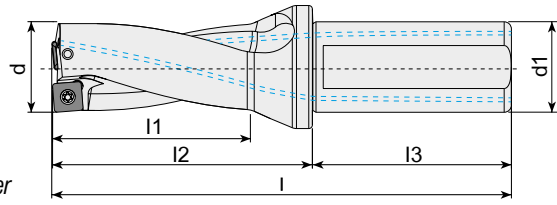

Takım Kodu Ordering Code Код для заказа	Stok Stock Наличие	Takım Ölçüleri (mm) Dimension (mm) Размеры (мм)							Kesici Uç Insert Пластина	Yedek Parçaları / Spare Parts / Запасные части	
		d	d1	d2	l	l1	l2	l3		Sıkma Vidası Screw Зажимной винт	Tork Anahtar Torx Key Торх Ключ
ATUM 12.5XD2 SPGT 050204	○	12.5	20	25	96	24	46	50	SPGT 050204	3006-M2x4	80-T06
ATUM 13XD2 SPGT 050204	●	13	20	25	98	26	48	50			
ATUM 13.5XD2 SPGT 050204	●	13.5	20	25	98	26	48	50			
ATUM 14XD2 SPGT 050204	●	14	20	25	100	28	50	50			
ATUM 15XD2 SPGT 050204	●	15	20	25	102	30	52	50			
ATUM 16XD2 SPGT 060204	●	16	25	34	110	32	54	56	SPGT 060204	3007-M2.2x5	80-T07
ATUM 16.5XD2 SPGT 060204	●	16.5	25	34	110	32	54	56			
ATUM 17XD2 SPGT 060204	●	17	25	34	112	34	56	56			
ATUM 17.5XD2 SPGT 060204	●	17.5	25	34	112	34	56	56			
ATUM 18XD2 SPGT 060204	●	18	25	34	114	36	58	56			
ATUM 19XD2 SPGT 060204	●	19	25	34	116	38	60	56			
ATUM 20XD2 SPGT 060204	●	20	25	34	118	40	62	56			
ATUM 22XD2 SPGT 07T308	●	22	25	34	122	44	66	56	SPGT 07T308	3008-M2.5x6	80-T08
ATUM 22.5XD2 SPGT 07T308	●	22.5	25	34	122	44	66	56			
ATUM 23XD2 SPGT 07T308	●	23	25	34	124	46	68	56			
ATUM 24XD2 SPGT 07T308	●	24	25	34	126	48	70	56			
ATUM 25XD2 SPGT 07T308	●	25	25	34	128	50	72	56			
ATUM 26XD2 SPGT 07T308	●	26	25	34	130	52	74	56	SPGT 090408	4015-M3.5x9	80-T15
ATUM 28XD2 SPGT 090408	●	28	25	34	134	56	78	56			
ATUM 29XD2 SPGT 090408	●	29	25	34	136	58	80	56			
ATUM 30XD2 SPGT 090408	●	30	32	44	147	60	87	60	SPGT 110408	4015-M4x11	80-T15
ATUM 32XD2 SPGT 090408	●	32	32	44	151	64	91	60			
ATUM 35XD2 SPGT 110408	●	35	32	44	157	70	97	60	SPGT 110408	4015-M4x11	80-T15
ATUM 36XD2 SPGT 110408	●	36	32	44	159	72	99	60			
ATUM 40XD2 SPGT 110408	●	40	32	44	167	80	107	60			

R: Sağ / Right / Правый L: Sol/Left/Левый
● Stokta / In Stock / В наличии ○ Stokta Yok / Non Stock Item / Нет в наличии
ZCC Ucuna Uygunudur. / Compatible with ZCC Insert. / Под пластину ZCC

Sipariş Örneği/Ordering Example/Образец заказа
1 ad./pcs./шт ATUM 12.5XD2 SPGT 050204

Takma Uçlu Matkap Kullanım Kılavuzu : S 319 / User's Guide For U-Drills : P 319
Руководство для эксплуатации сверел: стр. 320





Delme Derinliği = 3xÇap
Drilling Depth = 3xDiameter
Глубина сверления = 3xДиаметр

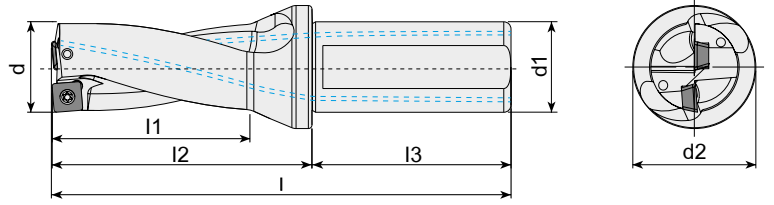

Takım Kodu Ordering Code Код для заказа	Stok Stock Наличие	Takım Ölçüleri (mm) Dimension (mm) Размеры (мм)							Kesici Uç Insert Пластина	Yedek Parçaları / Spare Parts / Залпасные части	
		d	d1	d2	l	l1	l2	l3		Sıkma Vidası Screw Зажимной винт	Tork Anahtar Torx Key Торх Ключ
ATUM 12.5XD3 SPGT 050204	●	12.5	20	25	108	36	58	50	SPGT 050204	3006-M2x4	80-T06
ATUM 13XD3 SPGT 050204	●	13	20	25	111	39	61	50			
ATUM 13.5XD3 SPGT 050204	●	13.5	20	25	111	39	61	50			
ATUM 14XD3 SPGT 050204	●	14	20	25	114	42	64	50			
ATUM 14.5XD3 SPGT 050204	●	14.5	20	25	114	42	64	50			
ATUM 15XD3 SPGT 050204	●	15	20	25	117	45	67	50			
ATUM 15.5XD3 SPGT 060204	●	15.5	20	25	117	45	67	50	SPGT 060204	3007-M2.2x5	80-T07
ATUM 16XD3 SPGT 060204	●	16	25	34	126	48	70	56			
ATUM 16.5XD3 SPGT 060204	●	16.5	25	34	126	48	70	56			
ATUM 17XD3 SPGT 060204	●	17	25	34	129	51	73	56			
ATUM 17.5XD3 SPGT 060204	●	17.5	25	34	129	51	73	56			
ATUM 18XD3 SPGT 060204	●	18	25	34	132	54	76	56			
ATUM 18.5XD3 SPGT 060204	●	18.5	25	34	132	54	76	56			
ATUM 19XD3 SPGT 060204	●	19	25	34	135	57	79	56			
ATUM 19.5XD3 SPGT 060204	●	19.5	25	34	135	57	79	56			
ATUM 20XD3 SPGT 060204	●	20	25	34	138	60	82	56			
ATUM 20.5XD3 SPGT 060204	●	20.5	25	34	138	60	82	56			
ATUM 21XD3 SPGT 060204	●	21	25	34	141	63	85	56			
ATUM 21.5XD3 SPGT 060204	●	21.5	25	34	141	63	85	56			
ATUM 22XD3 SPGT 07T308	●	22	25	34	144	66	88	56			
ATUM 22.5XD3 SPGT 07T308	●	22.5	25	34	144	66	88	56			
ATUM 23XD3 SPGT 07T308	●	23	25	34	147	69	91	56			
ATUM 23.5XD3 SPGT 07T308	●	23.5	25	34	147	69	91	56			
ATUM 24XD3 SPGT 07T308	●	24	25	34	150	72	94	56			
ATUM 24.5XD3 SPGT 07T308	●	24.5	25	34	150	72	94	56			
ATUM 25XD3 SPGT 07T308	●	25	25	34	153	75	97	56			
ATUM 25.5XD3 SPGT 07T308	●	25.5	25	34	153	75	97	56			
ATUM 26XD3 SPGT 07T308	●	26	25	34	156	78	100	56			
ATUM 26.5XD3 SPGT 07T308	●	26.5	25	34	156	78	100	56			
ATUM 27XD3 SPGT 07T308	●	27	25	34	159	81	103	56	SPGT 090408	4015-M3.5x9	80-T15
ATUM 27.5XD3 SPGT 07T308	●	27.5	25	34	159	81	103	56			
ATUM 28XD3 SPGT 090408	●	28	25	34	162	84	106	56			
ATUM 28.5XD3 SPGT 090408	●	28.5	25	34	162	84	106	56			
ATUM 29XD3 SPGT 090408	●	29	25	34	165	87	109	56			
ATUM 29.5XD3 SPGT 090408	●	29.5	25	34	165	87	109	56			
ATUM 30XD3 SPGT 090408	●	30	32	44	177	90	117	60			
ATUM 31XD3 SPGT 090408	●	31	32	44	180	93	120	60			
ATUM 32XD3 SPGT 090408	●	32	32	44	183	96	123	60			
ATUM 33XD3 SPGT 090408	●	33	32	44	186	99	126	60			

R: Sağ / Right / Правый L: Sol/Left/Левый
● Stokta / In Stock / В наличии ○ Stokta Yok / Non Stock Item / Нет в наличии
ZCC Uçuna Uygundur. / Compatible with ZCC Insert. / Под пластину ZCC

Sipariş Örneği/Ordering Example/Образец заказа
1 ad./pcs./шт ATUM 12.5XD3 SPGT 050204
Takma Uçlu Matkap Kullanım Kılavuzu : S 319 / User's Guide For U-Drills : P 319
Руководство для эксплуатации сверел: стр. 320



Delme Derinliği
Drilling Depth
Глубина сверления

= 3xÇap
= 4xÇap
= 3xDiameter
= 4xDiameter
= 3xДиаметр
= 4xДиаметр

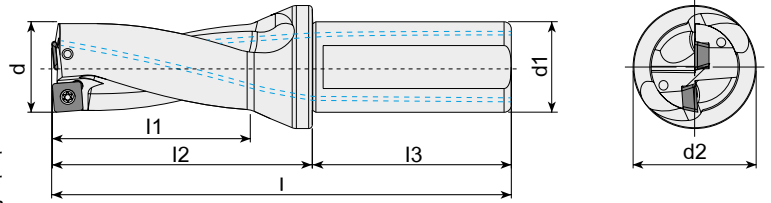

Takım Kodu
Ordering Code
Код для заказа

Stok
Stock
Наличие

Takım Ölçüleri (mm)
Dimension (mm)
Размеры (мм)

Kesici Uç
Insert
Пластина

Yedek Parçaları / Spare Parts / Запасные части

Sıkma Vidası
Screw
Зажимной винт

Tork Anahtar
Torx Key
Торх Ключ

Takım Kodu Ordering Code Код для заказа	Stok Stock Наличие	Takım Ölçüleri (mm) Dimension (mm) Размеры (мм)							Kesici Uç Insert Пластина	Sıkma Vidası Screw Зажимной винт	Tork Anahtar Torx Key Торх Ключ
		d	d ₁	d ₂	l	l ₁	l ₂	l ₃			
ATUM 34XD3 SPGT 110408	●	34	32	44	189	102	129	60	SPGT 110408	4015-M4x11	80-T15
ATUM 35XD3 SPGT 110408	●	35	32	44	192	105	132	60			
ATUM 37XD3 SPGT 110408	●	37	32	44	198	111	138	60			
ATUM 38XD3 SPGT 110408	●	38	32	44	201	114	141	60			
ATUM 39XD3 SPGT 110408	●	39	32	44	204	117	144	60			
ATUM 40XD3 SPGT 110408	●	40	32	44	207	120	147	60	SPGT 140512	1020-M5x11	80-T20
ATUM 42XD3 SPGT 140512	●	42	32	44	213	126	153	60			
ATUM 43XD3 SPGT 140512	●	43	32	44	216	129	156	60			
ATUM 44XD3 SPGT 140512	●	44	32	44	219	132	159	60			
ATUM 49XD3 SPGT 140512	●	49	40	54	249	147	179	70			
ATUM 50XD3 SPGT 140512	●	50	40	54	252	150	182	70			

R: Sağ / Right / Правый L: Sol/Left/Левый

● Stokta / In Stock / В наличии ○ Stokta Yok / Non Stock Item / Нет в наличии
ZCC Ucuna Uygundur. / Compatible with ZCC Insert. / Под пластину ZCC

Sipariş Örneği/Ordering Example/Образец заказа

1 ad./pcs./шт ATUM 34XD3 SPGT 110408

Takma Uçlu Matkap Kullanım Kılavuzu : S 319 / User's Guide For U-Drills : P 319

Руководство для эксплуатации сверел: стр. 320





Delme Derinliği = 4xÇap
Drilling Depth = 4xDiameter
Глубина сверления = 4xДиаметр

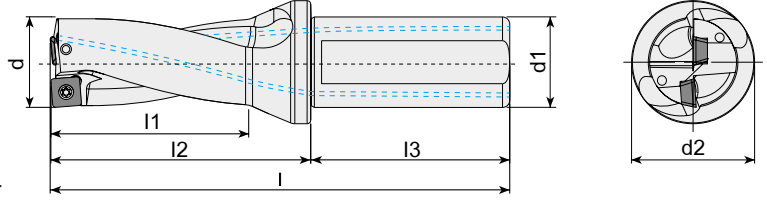

Takım Kodu Ordering Code Код для заказа	Stok Stock Наличие	Takım Ölçüleri (mm) Dimension (mm) Размеры (мм)							Kesici Uç Insert Пластина	Yedek Parçaları / Spare Parts / Запасные части		
		d	d1	d2	l	l1	l2	l3		Sıkma Vidası Screw Зажимной винт	Tork Anahtar Torx Key Торх Ключ	
ATUM 13XD4 SPGT 050204	●	13	20	25	124	52	74	50	SPGT 050204		3006-M2x4	80-T06
ATUM 14XD4 SPGT 050204	●	14	20	25	128	56	78	50				
ATUM 15XD4 SPGT 050204	●	15	20	25	132	60	82	50				
ATUM 16XD4 SPGT 060204	●	16	25	34	142	64	86	56				
ATUM 17XD4 SPGT 060204	●	17	25	34	146	68	90	56				
ATUM 17.5XD4 SPGT 060204	●	17.5	25	34	146	68	90	56				
ATUM 18XD4 SPGT 060204	●	18	25	34	150	72	94	56	SPGT 060204		3007-M2.2x5	80-T07
ATUM 19XD4 SPGT 060204	●	19	25	34	154	76	98	56				
ATUM 19.5XD4 SPGT 060204	●	19.5	25	34	154	76	98	56				
ATUM 20XD4 SPGT 060204	●	20	25	34	158	80	102	56				
ATUM 21XD4 SPGT 060204	●	21	25	34	162	84	106	56				
ATUM 22XD4 SPGT 07T308	●	22	25	34	166	88	110	56				
ATUM 23XD4 SPGT 07T308	●	23	25	34	170	92	114	56	SPGT 07T308		3008-M2.5x6	80-T08
ATUM 23.5XD4 SPGT 07T308	●	23.5	25	34	170	92	114	56				
ATUM 24XD4 SPGT 07T308	●	24	25	34	174	96	118	56				
ATUM 25XD4 SPGT 07T308	●	25	25	34	178	100	122	56				
ATUM 26XD4 SPGT 07T308	●	26	25	34	182	104	126	56				
ATUM 27.5XD4 SPGT 07T308	●	27.5	25	34	186	108	130	56				
ATUM 28XD4 SPGT 090408	●	28	25	34	190	112	134	56	SPGT 090408		4015-M3.5x9	80-T15
ATUM 29XD4 SPGT 090408	●	29	25	34	194	116	138	56				
ATUM 30XD4 SPGT 090408	●	30	32	44	207	120	147	60				
ATUM 33.5XD4 SPGT 090408	●	33.5	32	44	219	132	159	60				
ATUM 38XD4 SPGT 110408	●	38	32	44	239	152	179	60				

R: Sağ / Right / Правый L: Sol/Left/Левый
● Stokta / In Stock / В наличии ○ Stokta Yok / Non Stock Item / Нет в наличии
ZCC Ucuna Uygundur. / Compatible with ZCC Insert. / Под пластину ZCC

Sipariş Örneği/Ordering Example/Образец заказа
1 ad./pcs./шт ATUM 13XD4 SPGT 050204

Takma Uçlu Matkap Kullanım Kılavuzu : S 319 / User's Guide For U-Drills : P 319
Руководство для эксплуатации сверел: стр. 320





Delme Derinliği = 3xÇap
Drilling Depth = 3xDiameter
Глубина сверления = 3xДиаметр

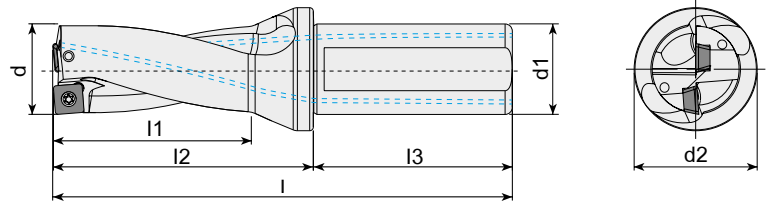

Takım Kodu Ordering Code Код для заказа	Stok Stock Наличие	Takım Ölçüleri (mm) Dimension (mm) Размеры (мм)								Kesici Uç Insert Пластина	Yedek Parçaları / Spare Parts / Запасные части	
		d	d1	d2	l	l1	l2	l3	Sıkma Vidası Screw Зажимной винт		Tork Anahtar Torx Key Торх Ключ	
ATUM 14XD3 SO.. 050204	●	14	20	25	114	42	64	50	SO.. 050204		3006-M2x4	80-T06
ATUM 15XD3 SO.. 050204	●	15	20	25	117	45	67	50				
ATUM 16XD3 SO.. 050204	●	16	25	34	126	48	70	56				
ATUM 16.5XD3 SO.. 050204	●	16.5	25	34	126	48	70	56				
ATUM 17XD3 SO.. 050204	●	17	25	34	129	51	73	56				
ATUM 17.5XD3 SO.. 050204	●	17.5	25	34	129	51	73	56	SO.. 060304		3007-M2.2x5	80-T07
ATUM 18XD3 SO.. 060304	●	18	25	34	132	54	76	56				
ATUM 19XD3 SO.. 060204	●	19	25	34	135	57	79	56				
ATUM 20XD3 SO.. 060304	●	20	25	34	138	60	82	56				
ATUM 22XD3 SO.. 070305	●	22	25	34	144	66	88	56				
ATUM 22.5XD3 SO.. 070305	●	22.5	25	34	144	66	88	56	SO.. 070305		3008-M2.5x6	80-T08
ATUM 23XD3 SO.. 070305	●	23	25	34	147	69	91	56				
ATUM 24XD3 SO.. 070305	●	24	25	34	150	72	94	56				
ATUM 25XD3 SO.. 09T306	●	25	25	34	153	75	97	56				
ATUM 26XD3 SO.. 09T306	●	26	25	34	156	78	100	56				
ATUM 27XD3 SO.. 09T306	●	27	25	34	159	81	103	56	SO.. 09T306		4010-M3x8	80-T10
ATUM 29XD3 SO.. 09T306	●	29	25	34	174	87	114	56				
ATUM 30XD3 SO.. 09T306	●	30	32	44	177	90	117	60				
ATUM 31XD3 SO.. 09T306	●	31	32	44	200	93	120	60				
ATUM 33XD3 SO.. 09T306	●	33	32	44	186	99	126	60				
ATUM 35XD3 SO.. 120408	●	35	32	44	192	105	132	60	SO..120408		4015-M4X11	80-T15
ATUM 36XD3 SO.. 120408	●	36	32	44	195	108	135	60				
ATUM 37XD3 SO.. 120408	●	37	32	44	198	111	138	60				
ATUM 38XD3 SO.. 120408	●	38	32	44	201	114	141	60				
ATUM 39XD3 SO.. 120408	●	39	32	44	204	117	144	60				
ATUM 40XD3 SO.. 120408	●	40	32	44	207	120	147	60				
ATUM 43XD3 SO.. 120408	●	43	32	44	216	129	156	60				

R: Sağ / Right / Правый L: Sol/Left/Левый
● Stokta / In Stock / В наличии ○ Stokta Yok / Non Stock Item / Нет в наличии
ISCR Ucuna Uygundur. / Compatible with ISCR Insert. / Под пластину ISCR

Sipariş Örneği/Ordering Example/Образец заказа
1 ad./pcs./шт ATUM 14XD3 SO.. 050204

Takma Uçlu Matkap Kullanım Kılavuzu : S 319 / User's Guide For U-Drills : P 319
Руководство для эксплуатации сверел: стр. 320



Delme Derinliği = 4xÇap
Drilling Depth = 4xDiameter
Глубина сверления = 4xДиаметр

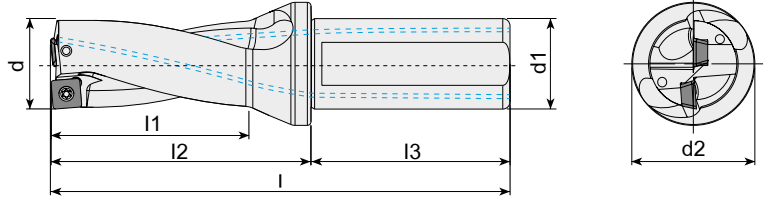

Takım Kodu Ordering Code Код для заказа	Stok Stock Наличие	Takım Ölçüleri (mm) Dimension (mm) Размеры (мм)							Kesici Uç Insert Пластина	Yedek Parçaları / Spare Parts / Запасные части	
		d	d1	d2	l	l1	l2	l3		Sıkma Vidası Screw Зажимной винт	Tork Anahtar Torx Key Торх Ключ
ATUM 14XD4 SO.. 050204	●	14	20	25	128	56	78	50	SO.. 050204	3006-M2x4	80-T06
ATUM 14.5XD4 SO.. 050204	●	14.5	20	25	128	56	78	50			
ATUM 15XD4 SO.. 050204	●	15	20	25	132	60	62	50			
ATUM 15.5XD4 SO.. 050204	●	15.5	20	25	132	60	82	50			
ATUM 17XD4 SO.. 050204	●	17	25	34	146	68	90	56	SO.. 060304	3007-M2.2x5	80-T07
ATUM 19XD4 SO.. 060304	●	19	25	34	154	76	98	56			
ATUM 19.5XD4 SO.. 060304	●	19.5	25	34	154	76	98	56			
ATUM 20XD4 SO.. 060304	●	20	25	34	158	80	102	56			
ATUM 21XD4 SO.. 070305	●	21	25	34	162	84	106	56	SO.. 070305	3008-M2.5x6	80-T08
ATUM 22XD4 SO.. 070305	●	22	25	34	166	88	110	56			
ATUM 22.5XD4 SO.. 070305	●	22.5	25	34	166	88	110	56			
ATUM 23XD4 SO.. 070305	●	23	25	34	170	92	114	56			
ATUM 24XD4 SO.. 070305	●	24	25	34	174	96	118	56	SO.. 09T306	4010-M3x8	80-T10
ATUM 25XD4 SO.. 09T306	●	25	25	34	178	100	122	56			
ATUM 27XD4 SO.. 09T306	●	27	25	34	186	108	130	56			
ATUM 28XD4 SO.. 09T306	●	28	25	34	190	112	134	56			
ATUM 29XD4 SO.. 09T306	●	29	25	34	194	116	138	56	SO.. 09T306	4010-M3x8	80-T10
ATUM 30XD4 SO.. 09T306	●	30	32	44	207	120	147	60			
ATUM 31XD4 SO.. 09T306	●	31	32	44	211	124	151	60			
ATUM 33XD4 SO.. 09T306	●	33	32	44	219	132	159	60			
ATUM 34XD4 SO.. 09T306	●	34	32	44	223	136	163	60	SO..120408	4015-M4X11	80-T15
ATUM 35XD4 SO.. 120408	●	35	32	44	227	140	167	60			

R: Sağ / Right / Правый L: Sol/Left/Левый
● Stokta / In Stock / В наличии ○ Stokta Yok / Non Stock Item / Нет в наличии
ISCR Ucuna Uygunudur. / Compatible with ISCR Insert. / Под пластину ISCR

Sipariş Örneği/Ordering Example/Образец заказа
1 ad./pcs./шт ATUM 14XD4 SO.. 050204

Takma Uçlu Matkap Kullanım Kılavuzu : S 319 / User's Guide For U-Drills : P 319
Руководство для эксплуатации сверел: стр. 320



Delme Derinliği = 2xÇap
Drilling Depth = 2xDiameter
Глубина сверления = 2xДиаметр

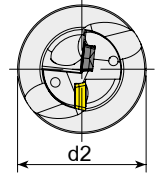
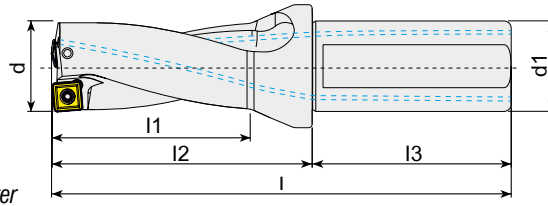

Takım Kodu Ordering Code Код для заказа	Stok Stock Наличие	Takım Ölçüleri (mm) Dimension (mm) Размеры (мм)							Kesici Uç Insert Пластина	Yedek Parçaları / Spare Parts / Запасные части	
		d	d ₁	d ₂	l	l ₁	l ₂	l ₃		Sikma Vidası Screw Зажимной винт	Tork Anahtar Torx Key Торх Ключ
ATUM 14XD2 KDR 0502..	●	14	20	25	100	28	50	50	SPMT 050204-XOMT 050204	3006-M2x4	80-T06
ATUM 18XD2 KDR 0602..	●	18	25	34	114	36	58	56			
ATUM 20XD2 KDR 07T2..	●	20	25	34	118	40	62	56	SPMT 07T208 XOMT 07T205	3008-M2.5x6	80-T08
ATUM 22XD2 KDR 07T2..	●	22	25	34	122	44	66	56			
ATUM 24XD2 KDR 0903..	●	24	25	34	126	48	70	56	SPMT 090308 XOMT 090305	3008-M3x7	80-T08
ATUM 25XD2 KDR 0903..	●	25	25	34	128	50	72	56			
ATUM 26XD2 KDR 0903..	●	26	25	34	130	52	74	56	SPMT 11T308 XOMT 11T306	4015-M3.5x9	80-T15
ATUM 28XD2 KDR 0903..	●	28	25	34	134	56	78	56			
ATUM 30XD2 KDR 11T3..	●	30	25	34	147	60	87	60	SPMT 11T308 XOMT 11T306	4015-M3.5x9	80-T15
ATUM 32XD2 KDR 11T3..	●	32	32	44	151	64	91	60			
ATUM 34XD2 KDR 11T3..	●	34	32	44	155	68	95	60			

KRLY Ucuna Uygundur. / Compatible with KRLY Insert. / Под пластину KRLY



Delme Derinliği = 4xÇap
Drilling Depth = 4xDiameter
Глубина сверления = 4xДиаметр

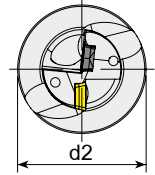
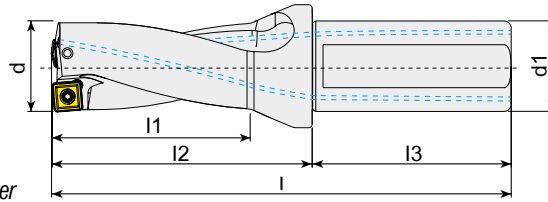

Takım Kodu Ordering Code Код для заказа	Stok Stock Наличие	Takım Ölçüleri (mm) Dimension (mm) Размеры (мм)							Kesici Uç Insert Пластина	Yedek Parçaları / Spare Parts / Запасные части	
		d	d ₁	d ₂	l	l ₁	l ₂	l ₃		Sikma Vidası Screw Зажимной винт	Tork Anahtar Torx Key Торх Ключ
ATUM 14XD4 KDR 0502..	●	14	20	25	128	56	78	50	SPMT 050204 XOMT 050204	3006-M2x4	80-T06
ATUM 14.5XD4 KDR 0502..	●	14.5	20	25	128	56	78	50			
ATUM 15XD4 KDR 0502..	●	15	20	25	132	60	82	50	SPMT 060205 XOMT 060204	3007-M2.2x5	80-T07
ATUM 15.5XD4 KDR 0502..	●	15.5	20	25	132	60	82	50			
ATUM 16XD4 KDR 0502..	●	16	25	34	142	64	86	56	SPMT 07T208 XOMT 07T205	3008-M2.5x6	80-T08
ATUM 17XD4 KDR 0602..	●	17	25	34	146	68	90	56			
ATUM 17.5XD4 KDR 0602..	●	17.5	25	34	146	68	90	56	SPMT 090308 XOMT 090305	3008-M3x7	80-T08
ATUM 18XD4 KDR 0602..	●	18	25	34	150	72	94	56			
ATUM 18.5XD4 KDR 0602..	●	18.5	25	34	150	72	94	56	SPMT 11T308 XOMT 11T306	4015-M3.5x9	80-T15
ATUM 19XD4 KDR 0602..	●	19	25	34	154	76	98	56			
ATUM 20XD4 KDR 07T2..	●	20	25	34	158	80	102	56	SPMT 07T208 XOMT 07T205	3008-M2.5x6	80-T08
ATUM 21XD4 KDR 07T2..	●	21	25	34	162	84	106	56			
ATUM 22XD4 KDR 07T2..	●	22	25	34	166	88	110	56	SPMT 090308 XOMT 090305	3008-M3x7	80-T08
ATUM 24XD4 KDR 0903..	●	24	25	34	174	96	118	56			
ATUM 25XD4 KDR 0903..	●	25	25	34	178	100	122	56			

R: Sağ / Right / Правый L: Sol/Left/Левый

● Stokta / In Stock / В наличии ○ Stokta Yok / Non Stock Item / Нет в наличии

KRLY Ucuna Uygundur. / Compatible with KRLY Insert. / Под пластину KRLY

Sipariş Örneği/Ordering Example/Образец заказа

1 ad./pcs./шт ATUM 14XD3 SO.. 050204

Takma Uçlu Matkap Kullanım Kılavuzu : S 319 / User's Guide For U-Drills : P 319 / Руководство для эксплуатации сверел: стр. 320



Delme Derinliği = 3xÇap
Drilling Depth = 3xDiameter
Глубина сверления = 3xДиаметр

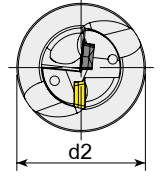
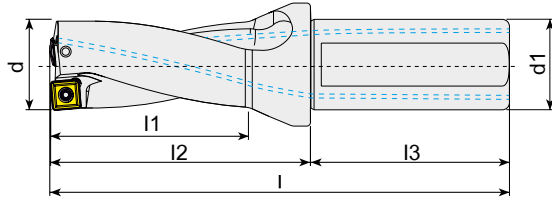

Takım Kodu Ordering Code Код для заказа	Stok Stock Наличие	Takım Ölçüleri (mm) Dimension (mm) Размеры (мм)							Kesici Uç Insert Пластина	Yedek Parçaları / Spare Parts / Запасные части		
		d	d1	d2	l	l1	l2	l3		Sikma Vidası Screw Зажимной винт	Tork Anahtar Torx Key Торх Ключ	
ATUM 12.5XD3 KDR 0402..	●	12.5	20	25	108	36	58	50	SPMT 040204 XOMT 040204		80-T06	
ATUM 13XD3 KDR 0402..	●	13	20	25	111	39	61	50				
ATUM 14XD3 KDR 0502..	●	14	20	25	114	42	64	50	SPMT 050204 XOMT 050204	3006-M2x4	80-T06	
ATUM 14.5XD3 KDR 0502..	●	14.5	20	25	114	42	64	50				
ATUM 15XD3 KDR 0502..	●	15	20	25	117	45	67	50	SPMT 060205 XOMT 060204	3007-M2.2x5	80-T07	
ATUM 15.5XD3 KDR 0502..	●	15.5	20	25	117	45	67	50				
ATUM 16XD3 KDR 0502..	●	16	25	34	126	48	70	56	SPMT 07T208 XOMT 07T205	3008-M2.5x6	80-T08	
ATUM 16.5XD3 KDR 0602..	●	16.5	25	34	126	48	70	56				
ATUM 17XD3 KDR 0602..	●	17	25	34	129	51	73	56	SPMT 090308 XOMT 090305	3008-M3x7	80-T08	
ATUM 17.5XD3 KDR 0602..	●	17.5	25	34	129	51	73	56				
ATUM 18XD3 KDR 0602..	●	18	25	34	132	54	76	56	SPMT 11T308 XOMT 11T306	4015-M3.5x9	80-T15	
ATUM 18.5XD3 KDR 0602..	●	18.5	25	34	132	54	76	56				
ATUM 19XD3 KDR 0602..	●	19	25	34	135	57	79	56	SPMT 130410 XOMT 130406	4015-M4x11	80-T15	
ATUM 19.5XD3 KDR 0602..	●	19.5	25	34	135	57	79	56				
ATUM 20XD3 KDR 07T2..	●	20	25	34	138	60	82	56	SPMT 11T308 XOMT 11T306	4015-M3.5x9	80-T15	
ATUM 20.5XD3 KDR 07T2..	●	20.5	25	34	138	60	82	56				
ATUM 21XD3 KDR 07T2..	●	21	25	34	141	63	85	56	SPMT 130410 XOMT 130406	4015-M4x11	80-T15	
ATUM 21.5XD3 KDR 07T2..	●	21.5	25	34	141	63	85	56				
ATUM 22XD3 KDR 07T2..	●	22	25	34	144	66	88	56	SPMT 130410 XOMT 130406	4015-M4x11	80-T15	
ATUM 22.5XD3 KDR 07T2..	●	22.5	25	34	144	66	88	56				
ATUM 23XD3 KDR 07T2..	●	23	25	34	147	69	91	56	SPMT 130410 XOMT 130406	4015-M4x11	80-T15	
ATUM 23.5XD3 KDR 07T2..	●	23.5	25	34	147	69	91	56				
ATUM 24XD3 KDR 0903..	●	24	25	34	150	72	94	56	SPMT 130410 XOMT 130406	4015-M4x11	80-T15	
ATUM 24.5XD3 KDR 0903..	●	24.5	25	34	150	72	94	56				
ATUM 25XD3 KDR 0903..	●	25	25	34	153	75	97	56	SPMT 130410 XOMT 130406	4015-M4x11	80-T15	
ATUM 25.5XD3 KDR 0903..	●	25.5	25	34	153	75	97	56				
ATUM 26XD3 KDR 0903..	●	26	25	34	156	78	100	56	SPMT 130410 XOMT 130406	4015-M4x11	80-T15	
ATUM 26.5XD3 KDR 0903..	●	26.5	25	34	156	78	100	56				
ATUM 27XD3 KDR 0903..	●	27	25	34	159	81	103	56	SPMT 130410 XOMT 130406	4015-M4x11	80-T15	
ATUM 27.5XD3 KDR 0903..	●	27.5	25	34	159	81	103	56				
ATUM 28XD3 KDR 0903..	●	28	25	34	162	84	106	56	SPMT 130410 XOMT 130406	4015-M4x11	80-T15	
ATUM 28.5XD3 KDR 0903..	●	28.5	25	34	162	84	106	56				
ATUM 29XD3 KDR 0903..	●	29	25	34	165	87	109	56	SPMT 130410 XOMT 130406	4015-M4x11	80-T15	
ATUM 29.5XD3 KDR 0903..	●	29.5	25	34	165	87	109	56				
ATUM 30XD3 KDR 11T3..	●	30	32	44	177	90	117	60	SPMT 130410 XOMT 130406	4015-M4x11	80-T15	
ATUM 30.5XD3 KDR 11T3..	●	30.5	32	44	177	90	117	60				
ATUM 32XD3 KDR 11T3..	●	32	32	44	183	96	123	60	SPMT 130410 XOMT 130406	4015-M4x11	80-T15	
ATUM 32.5XD3 KDR 11T3..	●	32.5	32	44	183	96	123	60				
ATUM 33XD3 KDR 11T3..	●	33	32	44	186	99	126	60	SPMT 130410 XOMT 130406	4015-M4x11	80-T15	
ATUM 33.5XD3 KDR 11T3..	●	33.5	32	44	186	99	126	60				
ATUM 34XD3 KDR 11T3..	●	34	32	44	189	102	129	60	SPMT 130410 XOMT 130406	4015-M4x11	80-T15	
ATUM 34.5XD3 KDR 11T3..	●	34.5	32	44	189	102	129	60				
ATUM 35XD3 KDR 11T3..	●	35	32	44	192	105	132	60	SPMT 130410 XOMT 130406	4015-M4x11	80-T15	
ATUM 35.5XD3 KDR 11T3..	●	35.5	32	44	192	105	132	60				
ATUM 37XD3 KDR 1304..	●	37	32	44	198	111	138	60	SPMT 130410 XOMT 130406	4015-M4x11	80-T15	
ATUM 37.5XD3 KDR 1304..	●	37.5	32	44	198	111	138	60				
ATUM 38XD3 KDR 1304..	●	38	32	44	201	114	141	60	SPMT 130410 XOMT 130406	4015-M4x11	80-T15	
ATUM 38.5XD3 KDR 1304..	●	38.5	32	44	201	114	141	60				
ATUM 39XD3 KDR 1304..	●	39	32	44	204	117	144	60	SPMT 130410 XOMT 130406	4015-M4x11	80-T15	
ATUM 39.5XD3 KDR 1304..	●	39.5	32	44	204	117	144	60				
ATUM 40XD3 KDR 1304..	●	40	32	44	207	120	147	60	SPMT 130410 XOMT 130406	4015-M4x11	80-T15	
ATUM 40.5XD3 KDR 1304..	●	40.5	32	44	207	120	147	60				

R: Sağ / Right / Правый L: Sol/Left/Левый
● Stokta / In Stock / В наличии ○ Stokta Yok / Non Stock Item / Нет в наличии
KRLY Ucuna Uygunudur. / Compatible with KRLY Insert. / Под пластину KRLY

Sipariş Örneği/Ordering Example/Образец заказа
1 ad./pcs./шт ATUM 12.5XD3 KDR 0402..

Takma Uçlu Matkap Kullanım Kılavuzu : S 319 / User's Guide For U-Drills : P 319
Руководство для эксплуатации сверел : стр. 320



Delme Derinliği = 2xÇap
Drilling Depth = 2xDiameter
Глубина сверления = 2xДиаметр

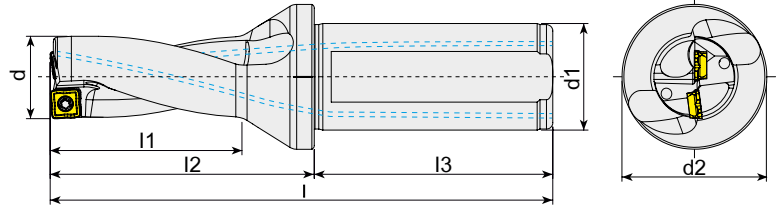

Takım Kodu Ordering Code Код для заказа	Stok Stock Наличие	Takım Ölçüleri (mm) Dimension (mm) Размеры (мм)							Kesici Uç Insert Пластина	Yedek Parçaları / Spare Parts / Запасные части	
		d	d ₁	d ₂	l	l ₁	l ₂	l ₃		Sıkma Vidası Screw Зажимной винт	Tork Anahtar Torx Key Торх Ключ
ATUM 14XD2 SOMT 050204	●	14	20	25	100	28	50	50			
ATUM 16XD2 SOMT 050204	●	16	25	34	110	32	54	56	SOMT 050204	3006-M2x4	80-T06
ATUM 17XD2 SOMT 060204	●	17	25	34	112	34	56	56	SOMT 060204	3007-M2.2x5	80-T07
ATUM 18XD2 SOMT 060204	●	18	25	34	114	36	58	56	SOMT 070306		
ATUM 20XD2 SOMT 070306	●	20	25	34	118	40	62	56	SOMT 070306	3008-M2.5x6	80-T08
ATUM 22XD2 SOMT 070306	●	22	25	34	122	44	66	56	SOMT 08T306		
ATUM 24XD2 SOMT 08T306	●	24	25	34	126	48	70	56	SOMT 08T306	4015-M3.5x9	80-T15
ATUM 25XD2 SOMT 08T306	●	25	25	34	128	50	72	56	SOMT 09T308		
ATUM 26XD2 SOMT 08T306	●	26	25	34	130	52	74	56	SOMT 09T308	4015-M4x11	80-T20
ATUM 27XD2 SOMT 09T308	●	27	25	34	132	54	76	56	SOMT 11T308		
ATUM 28XD2 SOMT 09T308	●	28	25	34	134	56	78	56	SOMT 11T308		
ATUM 30XD2 SOMT 09T308	●	30	32	44	147	60	87	60	SOMT 11T308	1020-M5x11	80-T20
ATUM 32XD2 SOMT 11T308	●	32	32	44	151	64	91	60	SOMT 130408		
ATUM 33XD2 SOMT 11T308	●	33	32	44	153	66	93	60	SOMT 130408		
ATUM 34XD2 SOMT 11T308	●	34	32	44	155	68	95	60	SOMT 130408	4015-M4x11	80-T20
ATUM 35XD2 SOMT 11T308	●	35	32	44	157	70	97	60	SOMT 150510		
ATUM 37XD2 SOMT 130408	●	37	32	44	161	74	101	60	SOMT 130408	1020-M5x11	80-T20
ATUM 38XD2 SOMT 130408	●	38	32	44	163	76	103	60	SOMT 130408		
ATUM 40XD2 SOMT 130408	●	40	32	44	167	80	107	60	SOMT 150510	1020-M5x11	80-T20
ATUM 45XD2 SOMT 150510	●	45	40	54	192	90	122	70	SOMT 150510		

R: Sağ / Right / Правый L: Sol/Left/Левый
● Stokta / In Stock / В наличии ○ Stokta Yok / Non Stock Item / Нет в наличии
TGTC Ucuna Uygundur. / Compatible with TGTC Insert. / Под пластину TGTC

Sipariş Örneği/Ordering Example/Образец заказа
1 ad./pcs./шт ATUM 14XD2 SOMT 050204

Takma Uçlu Matkap Kullanım Kılavuzu : S 319 / User's Guide For U-Drills : P 319
Руководство для эксплуатации сверел : стр. 320



Delme Derinliği = 3xÇap
Drilling Depth = 3xDiameter
Глубина сверления = 3xДиаметр

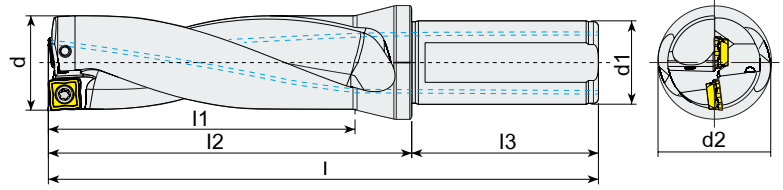

Takım Kodu Ordering Code Код для заказа	Stok Stock Наличие	Takım Ölçüleri (mm) Dimension (mm) Размеры (мм)							Kesici Uç Insert Пластина	Yedek Parçaları / Spare Parts / Запасные части		
		d	d ₁	d ₂	l	l ₁	l ₂	l ₃		Sıkma Vidası Screw Зажимной винт	Tork Anahtar Torx Key Торх Ключ	
ATUM 14XD3 SOMT 050204	●	14	20	25	114	42	64	50	SOMT 050204	3006-M2x4	80-T06	
ATUM 14.5XD3 SOMT 050204	●	14.5	20	25	114	42	64	50				
ATUM 15XD3 SOMT 050204	●	15	20	25	117	45	67	50				
ATUM 15.5XD3 SOMT 050204	●	15.5	20	25	117	45	67	50				
ATUM 16XD3 SOMT 050204	●	16	25	34	126	48	70	56	SOMT 060204	3007-M2.2x5	80-T07	
ATUM 16.5XD3 SOMT 060204	●	16.5	25	34	126	48	70	56				
ATUM 17XD3 SOMT 060204	●	17	25	34	129	51	73	56				
ATUM 17.5XD3 SOMT 060204	●	17.5	25	34	129	51	73	56				
ATUM 18XD3 SOMT 060204	●	18	25	34	132	54	76	56	SOMT 070306	3008-M2.5x6	80-T08	
ATUM 18.5XD3 SOMT 060204	●	18.5	25	34	132	54	76	56				
ATUM 19XD3 SOMT 060204	●	19	25	34	135	57	79	56				
ATUM 19.5XD3 SOMT 070306	●	19.5	25	34	135	57	79	56				
ATUM 20XD3 SOMT 070306	●	20	25	34	138	60	82	56	SOMT 08T306	4015-M3.5x9	80-T15	
ATUM 20.5XD3 SOMT 070306	●	20.5	25	34	138	60	82	56				
ATUM 21XD3 SOMT 070306	●	21	25	34	141	63	85	56				
ATUM 22XD3 SOMT 070306	●	22	25	34	144	66	88	56				
ATUM 22.5XD3 SOMT 08T306	●	22.5	25	34	144	66	88	56	SOMT 09T308	4015-M4x11	80-T20	
ATUM 23XD3 SOMT 08T306	●	23	25	34	147	69	91	56				
ATUM 23.5XD3 SOMT 08T306	●	23.5	25	34	147	69	91	56				
ATUM 24XD3 SOMT 08T306	●	24	25	34	150	72	94	56				
ATUM 24.5XD3 SOMT 08T306	●	24.5	25	34	150	72	94	56	SOMT 11T308	1020-M5x11	80-T20	
ATUM 25XD3 SOMT 08T306	●	25	25	34	153	75	97	56				
ATUM 26XD3 SOMT 08T306	●	26	25	34	156	78	100	56				
ATUM 27XD3 SOMT 09T308	●	27	25	34	159	81	103	56				
ATUM 27.5XD3 SOMT 09T308	●	27.5	25	34	159	81	103	56	SOMT 130408	1020-M5x11	80-T20	
ATUM 28XD3 SOMT 09T308	●	28	25	34	162	84	106	56				
ATUM 29XD3 SOMT 09T308	●	29	25	34	165	87	109	56				
ATUM 30XD3 SOMT 09T308	●	30	32	44	177	90	117	60				
ATUM 32XD3 SOMT 11T308	●	32	32	44	183	96	123	60	SOMT 150510	1020-M5x11	80-T20	
ATUM 33XD3 SOMT 11T308	●	33	32	44	186	99	126	60				
ATUM 34XD3 SOMT 11T308	●	34	32	44	189	102	129	60				
ATUM 35XD3 SOMT 11T308	●	35	32	44	192	105	132	60				
ATUM 36XD3 SOMT 11T308	●	36	32	44	195	108	135	60	SOMT 130408	1020-M5x11	80-T20	
ATUM 37XD3 SOMT 130408	●	37	32	44	198	111	138	60				
ATUM 38XD3 SOMT 130408	●	38	32	44	201	114	141	60				
ATUM 39XD3 SOMT 130408	●	39	32	44	204	117	144	60				
ATUM 40XD3 SOMT 130408	●	40	32	44	207	120	147	60	SOMT 150510	1020-M5x11	80-T20	
ATUM 45XD3 SOMT 150510	●	45	40	54	237	135	167	70				
ATUM 49XD3 SOMT 150510	●	49	40	54	249	147	179	70				
ATUM 50XD3 SOMT 150510	●	50	40	54	252	150	182	70				

R: Sağ / Right / Правый L: Sol/Left/Левый
● Stokta / In Stock / В наличии ○ Stokta Yok / Non Stock Item / Нет в наличии
TGTC Ucuna Uygundur. / Compatible with TGTC Insert. / Под пластину TGTC

Sipariş Örneği/Ordering Example/Образец заказа
1 ad./pcs./шт ATUM 14XD3 SOMT 050204

Takma Uçlu Matkap Kullanım Kılavuzu : S 319 / User's Guide For U-Drills : P 319
Руководство для эксплуатации сверел: стр. 320



Delme Derinliği = 4xÇap
Drilling Depth = 4xDiameter
Глубина сверления = 4xДиаметр

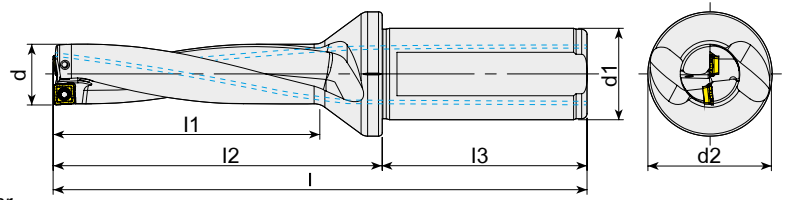

Takım Kodu
Ordering Code
Код для заказа

Stok
Stock
Наличие

Takım Ölçüleri (mm)
Dimension (mm)
Размеры (мм)

Kesici Uç
Insert
Пластина

Yedek Parçaları / Spare Parts / Запасные части

Sıkma Vidası
Screw
Зажимной Винт

Tork Anahtar
Torx Key
Торх Ключ

Takım Kodu Ordering Code Код для заказа	Stok Stock Наличие	d	d ₁	d ₂	l	l ₁	l ₂	l ₃	Kesici Uç Insert Пластина	Yedek Parçaları / Spare Parts / Запасные части	
										Sıkma Vidası Screw Зажимной Винт	Tork Anahtar Torx Key Торх Ключ
ATUM 14XD4 SOMT 050204	●	14	20	25	128	56	78	50	SOMT 050204	3006-M2x4	80-T06
ATUM 14.5XD4 SOMT 050204	●	14.5	20	25	128	56	78	50			
ATUM 16XD4 SOMT 050204	●	16	25	34	142	64	86	56			
ATUM 17XD4 SOMT 060204	●	17	25	34	146	68	90	56	SOMT 060204	3007-M2.2x5	80-T07
ATUM 17.5XD4 SOMT 060204	●	17.5	25	34	146	68	90	56			
ATUM 18XD4 SOMT 060204	●	18	25	34	150	72	94	56			
ATUM 19XD4 SOMT 060204	●	19	25	34	154	76	98	56	SOMT 070306	3008-M2.5x6	80-T08
ATUM 20XD4 SOMT 070306	●	20	25	34	158	80	102	56			
ATUM 21XD4 SOMT 070306	●	21	25	34	162	84	106	56			
ATUM 22XD4 SOMT 070306	●	22	25	34	166	88	110	56	SOMT 08T306	3008-M2.5x6	80-T08
ATUM 24XD4 SOMT 08T306	●	24	25	34	174	96	118	56			
ATUM 25XD4 SOMT 08T306	●	25	25	34	178	100	122	56			

R: Sağ / Right / Правый L: Sol/Left/Левый

● Stokta / In Stock / В наличии ○ Stokta Yok / Non Stock Item / Нет в наличии
TGTC Ucuna Uygunudur. / Compatible with TGTC Insert. / Под пластину TGTC

Sipariş Örneği/Ordering Example/Образец заказа
1 ad./pcs./шт ATUM ATUM 14XD4 SOMT 050204

Takma Uçlu Matkap Kullanım Kılavuzu : S 319 / User's Guide For U-Drills : P 319
Руководство для эксплуатации сверел: стр. 320





Delme Derinliği = 5xÇap
Drilling Depth = 5xDiameter
Глубина сверления = 5xДиаметр

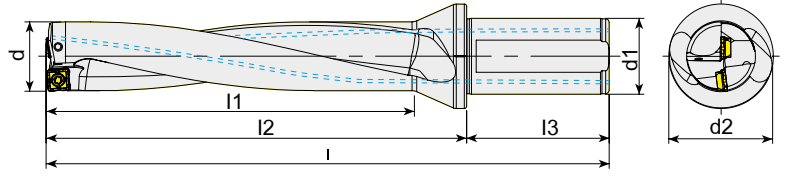

Takım Kodu Ordering Code Код для заказа	Stok Stock Наличие	Takım Ölçüleri (mm) Dimension (mm) Размеры (мм)							Kesici Uç Insert Пластина	Yedek Parçaları / Spare Parts / Запасные части	
		d	d ₁	d ₂	l	l ₁	l ₂	l ₃		Sıkma Vidası Screw Зажимной винт	Tork Anahtar Torx Key Торх Ключ
ATUM 13XD5 SOMT 050204	●	13	20	25	137	65	87	50	SOMT 050204	3006-M2x4	80-T06
ATUM 14XD5 SOMT 050204	●	14	20	25	142	70	92	50			
ATUM 15XD5 SOMT 050204	●	15	20	25	147	75	97	50			
ATUM 15.5XD5 SOMT 050204	●	15.5	20	25	147	75	97	50			
ATUM 16XD5 SOMT 050204	●	16	25	34	158	80	102	56			
ATUM 17.5XD5 SOMT 060204	●	17	25	34	163	85	107	56	SOMT 060204	3007-M2.2x5	80-T07
ATUM 18XD5 SOMT 060204	●	18	25	34	168	90	112	56			
ATUM 19XD5 SOMT 060204	●	19	25	34	173	95	117	56			
ATUM 19.5XD5 SOMT 070306	●	19	25	34	173	95	117	56	SOMT 070306	3008-M2.5x6	80-T08
ATUM 20XD5 SOMT 070306	●	20	25	34	178	100	122	56			
ATUM 21XD5 SOMT 070306	●	21	25	34	183	105	127	56			
ATUM 22XD5 SOMT 070306	●	22	25	34	188	110	132	56			
ATUM 23XD5 SOMT 08T306	●	23	25	34	193	115	137	56	SOMT 08T306	4015-M3.5x9	80-T15
ATUM 24XD5 SOMT 08T306	●	24	25	34	198	120	142	56			
ATUM 25XD5 SOMT 08T306	●	25	25	34	203	125	147	56			
ATUM 26XD5 SOMT 08T306	●	26	25	34	208	130	152	56			
ATUM 27XD5 SOMT 09T308	●	27	25	34	213	135	157	56	SOMT 09T308	4015-M3.5x9	80-T15
ATUM 28XD5 SOMT 09T308	●	28	25	34	218	140	162	56			
ATUM 29XD5 SOMT 09T308	●	29	25	34	223	145	167	56			
ATUM 30XD5 SOMT 09T308	●	30	32	44	237	150	177	60	SOMT 11T308	4015-M3.5x9	80-T15
ATUM 33XD5 SOMT 11T308	●	33	32	44	252	165	192	60			
ATUM 34XD5 SOMT 11T308	●	34	32	44	257	170	197	60			
ATUM 35XD5 SOMT 11T308	●	35	32	44	262	175	202	60			
ATUM 36XD5 SOMT 11T308	●	36	32	44	267	180	207	60			

R: Sağ / Right / Правый L: Sol/Left/Левый
● Stokta / In Stock / В наличии ○ Stokta Yok / Non Stock Item / Нет в наличии
TGTC Uçuna Uygundur. / Compatible with TGTC Insert. / Под пластину TGTC

Sipariş Örneği/Ordering Example/Образец заказа
1 ad./pcs./шт ATUM 13XD5 SOMT 050204

Takma Uçlu Matkap Kullanım Kılavuzu : S 319 / User's Guide For U-Drills : P 319
Руководство для эксплуатации сверел: стр. 320

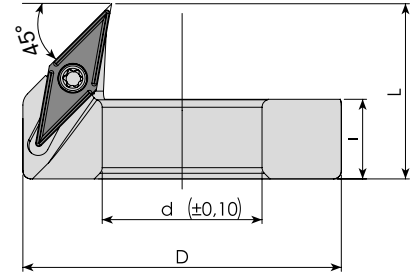

Takım Kodu Ordering Code Код для заказа	Stok Stock Наличие	Takım Ölçüleri (mm) Dimension (mm) Размеры (мм)				Kullanılacak ATUM Ölçüsü Соплатіле ATUM Diameter Диаметр сверла	Yedek Parçaları / Spare Parts / Запасные части				
		D	d	l	L		ATUM Ø	Kesici Uç Insert Пластина	Sıkma Vidası Screw Зажимной винт	Tork Anahtar Torx Key Торк Ключ	Montaj Vidası Mounting Screw Монтажный винт
ADCR-120-VB1103	●	32	12	10	22	12.5	VBM. 1103..	4008-M2.5x6	80-T08	AAV-14-M5x14	AAL-03-3
ADCR-125-VB1103	●	32.5	12.5	10	22	13					
ADCR-130-VB1103	●	33	13	10	22	13.5					
ADCR-135-VB1103	●	33.5	13.5	10	22	14					
ADCR-140-VB1103	●	34	14	10	22	14.5					
ADCR-145-VB1103	●	34.5	14.5	10	22	15					
ADCR-150-VB1103	●	35	15	10	22	15.5 - 16					
ADCR-155-VB1103	●	35.5	15.5	10	22	16.5					
ADCR-160-VB1103	●	36	16	10	22	17					
ADCR-165-VB1103	●	36.5	16.5	10	22	17.5					
ADCR-170-VB1103	●	37	17	10	22	18					
ADCR-175-VB1103	●	37.5	17.5	10	22	18.5					
ADCR-180-VB1103	●	38	18	10	22	19					
ADCR-185-VB1103	●	38.5	18.5	10	22	19.5					
ADCR-190-VB1103	●	39	19	10	22	20					
ADCR-195-VB1103	●	39.5	19.5	10	22	20.5					
ADCR-200-VB1103	●	40	20	10	22	21					
ADCR-205-VB1103	●	40.5	20.5	10	22	21.5					
ADCR-210-VB1103	●	41	21	10	22	22					
ADCR-215-VB1103	●	41.5	21.5	10	22	22.5					
ADCR-220-VB1103	●	42	22	10	22	23					
ADCR-225-VB1103	●	42.5	22.5	10	22	23.5					
ADCR-230-VB1103	●	43	23	10	22	24					
ADCR-235-VB1103	●	43.5	23.5	10	22	24.5					
ADCR-240-VB1103	●	44	24	10	22	25					
ADCR-245-VB1103	●	44.5	24.5	10	22	25.5					
ADCR-250-VB1103	●	45	25	10	22	26					
ADCR-255-VB1103	●	45.5	25.5	10	22	26.5					
ADCR-260-VB1103	●	46	26	10	22	27					
ADCR-265-VB1103	●	46.5	26.5	10	22	27.5					
ADCR-270-VB1103	●	47	27	10	22	28					
ADCR-275-VB1103	●	47.5	27.5	10	22	28.5					
ADCR-280-VB1103	●	48	28	10	22	29					
ADCR-285-VB1103	●	48.5	28.5	10	22	29.5					
ADCR-290-VB1103	●	49	29	10	22	30					
ADCR-295-VB1103	●	49.5	29.5	10	22	30.5					
ADCR-300-VB1103	●	50	30	10	22	31					

R: Sağ / Right / Правый L: Sol/Left/Левый

● Stokta / In Stock / В наличии ○ Stokta Yok / Non Stock Item / Нет в наличии

Sipariş Örneği/Ordering Example/Образец заказа

1 ad./pcs./шт ADCR-120-VB1103

Takma Uçlu Matkap Kullanım Kılavuzu : S 319 / User's Guide For U-Drills : P 319

Руководство для эксплуатации сверел: стр. 320

Tavsiye Edilen / Recommended / Рекомендации

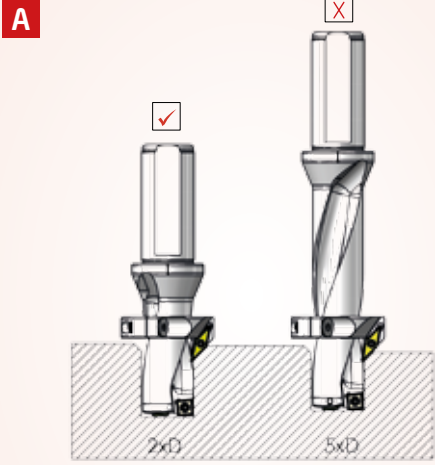

Mümkünse, her zaman kısa bir delme takımı kullanın. Değilse, titreşimi en aza indirmek için kesme hızını azaltın.

If possible, use it always short drilling tools. Otherwise, reduce your speeds to minimize vibration.
По возможности используйте на коротких сверлах. В противном случае, уменьшите скорость вращения, чтобы минимизировать вибрацию.

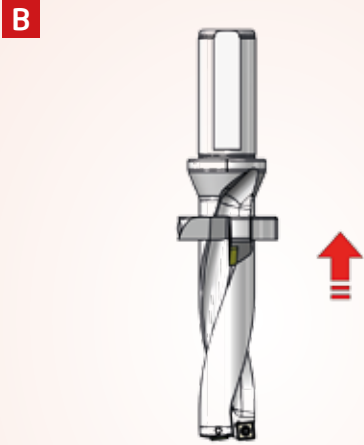

Mümkün olduğunca pah kırma halkasını shaft kısmına yakın montaj yap.

Get close to the mounting shaft of the chamfering ring as possible.

Установите фасочное кольцо как можно ближе к хвостовику

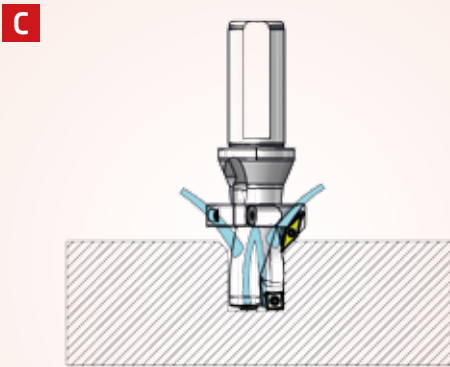

Daha iyi uç ömrü için harici soğutucu ve matkap ucu iç soğutucu uygulamak.

Apply external cooling and internal coolant drill for a better life for inserts.

Применяйте наружную и внутреннюю подачу СОЖ для дольшего срока службы пластин.

Montaj Şekli / Mounting System / Система установки



Matkap gövdesi üzerine pah kırma halkasını takın.

Put the chamfering ring to drill body.

Наденьте кольцо на сверло



İstenilen konuma pah kırma halkasını kaydırın.

Please slide chamfering ring to the desired position.

Установите кольцо в нужном положении



Pah kırma halkasını talaş akışına mani olmayacak şekilde helis başlangıcına denk getirin.

Please keep chamfering ring position which will not resist to fluiding chips and try to be equal to the helix start points.

Пожалуйста, зафиксируйте кольцо в таком положении, чтобы оно не препятствовало отводу стружки и было соосно начальным точкам спирали сверла.

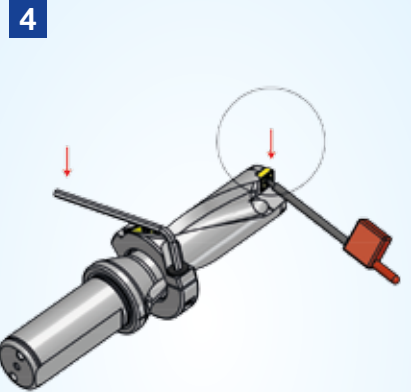

Pah kırma halkasını sıkın ve matkabin uçlarını takın.

Tightening the chamfering ring and put the drill insert.

Затяните фасочное кольцо и вставьте пластины в сверло.

Pah kırma halkasının doğru montaj şekli.
Proper installation of chamfering rings.
Правильная установка колец для снятия фаски.

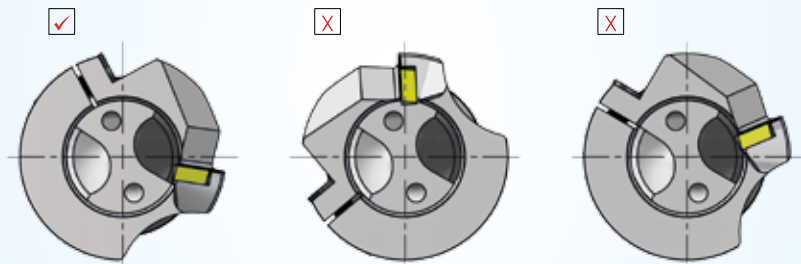

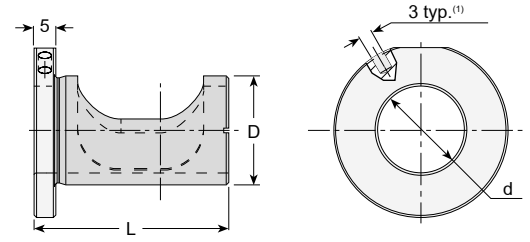

Takım Kodu
Ordering Code
Код для заказа

Stok
Stock
Наличие

Takım Ölçüleri (mm)
Dimension (mm)
Размеры (мм)

	d	D	L
AET-2025	20	25	44
AET-2532	25	32	46
AET-3240	32	40	55

■ (1) Delik ince bir metal yardımıyla adaptörün radyal olarak ayarlanmasını kolaylaştırmak için kullanılır. / Holes for inserting a pin, used to facilitate radial adjustment of the sleeve (pin not supplied).
Отверстия для вставки штифта, используемые для облегчения радиальной регулировки адаптера (штифт в комплект не входит).

Frezeleme tezgahında takma uçlu matkabın nominal çapı, matkabın ekseninin, spindle eksenine göre ötelenmesiyle değiştirilebilir.
On a milling machine the drill's nominal diameter can be changed by shifting the drill's axis out of the tool spindle.

На фрезерном станке номинальный диаметр сверла можно изменить, сместив ось сверла относительно оси шпинделя.

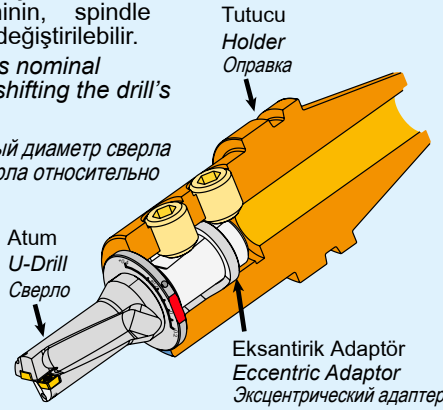
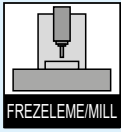

Radyal ayarlama pimi.
(Verilmeyecektir.)

Radial adjustment pin. (not supplied)

Штифт для радиальной регулировки
(в комплект не входит)

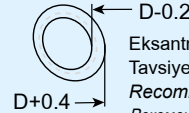
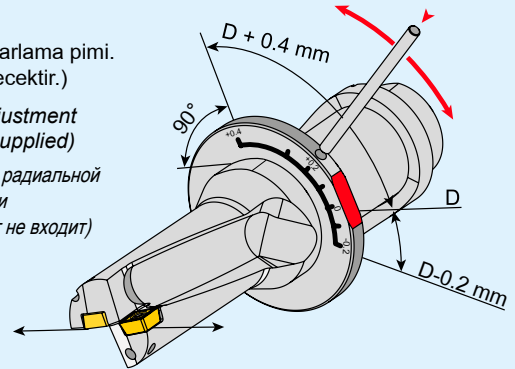

Eksantrik Adaptörü Kullanırken (AET)

Tavsiye Edilen İlerleme Hızı
Recommended Feed When Using Eccentric Adaptor
Рекомендуемая скорость подачи при использовании эксцентрического адаптера

Tavsiye Edilen İlerleme Hızı / Recommended Feed Rate / Рекомендуемая скорость подачи

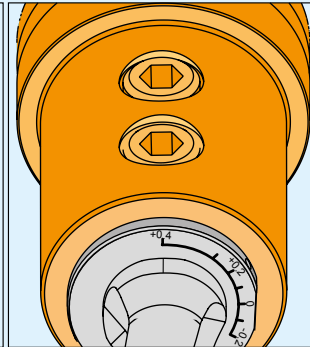
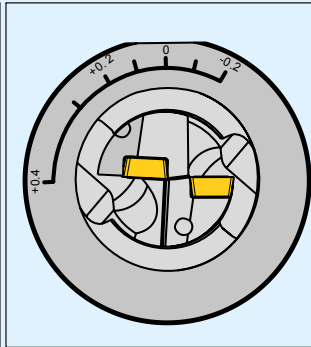
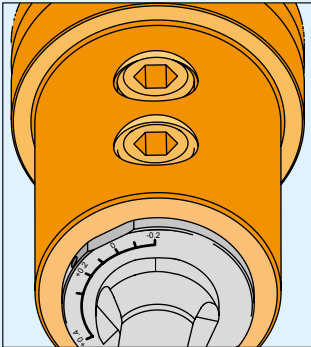
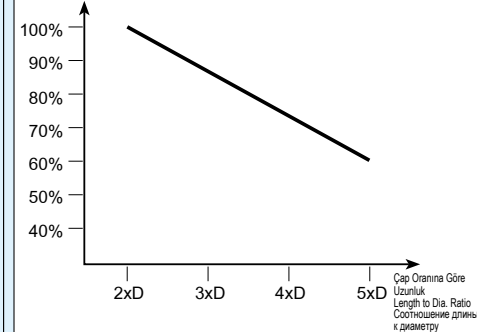

Delik Çapı
24.8 mm
Hole Diameter
Диаметр отверстия

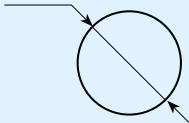

U-Drill Çapı = 25 mm
Drill Diameter = 25 mm
Диаметр сверления = 25 мм.

Delik Çapı
25 mm
Hole Diameter
Диаметр отверстия

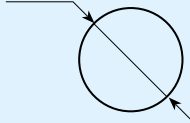

U-Drill Çapı = 25 mm
Drill Diameter = 25 mm
Диаметр сверления = 25 мм.

Delik Çapı
25.4 mm
Hole Diameter
Диаметр отверстия

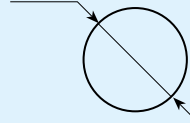

U-Drill Çapı = 25 mm
Drill Diameter = 25 mm
Диаметр сверления = 25 мм.

ATUM'un üzerindeki düz çizgi adaptörün sıfır rakamının üzerine konulmalıdır. AET'nin (eksantrik adaptörün) çevrilmesini kolaylaştırmak için AET'nin üzerindeki deliğe, metal bir çubuk ya da vida anahtarı yerleştirilebilir. AET'yi ayarlamadan önce tutucunun vidasını hafifçe çözün.

The adjustment markings should be located perpendicular to the flat on the circumference of the U-DRILL flange.

To facilitate the rotation of the adaptor, a metal rod or a screw key may be inserted into a hole on the eccentric adaptor flange. Unlock adaptor screw before adjusting adaptor.

Регулировочные метки должны быть расположены перпендикулярно к прямой по окружности фланца сверла.

Чтобы облегчить вращение адаптера металлический шток или ключ необходимо вставить в отверстие во фланец эксцентрического адаптера.

Отпустите винт адаптера перед его настройкой.

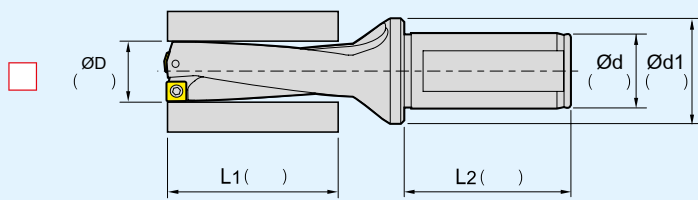
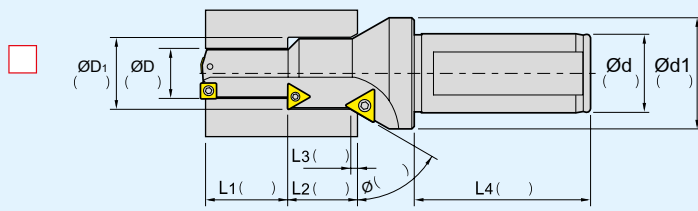
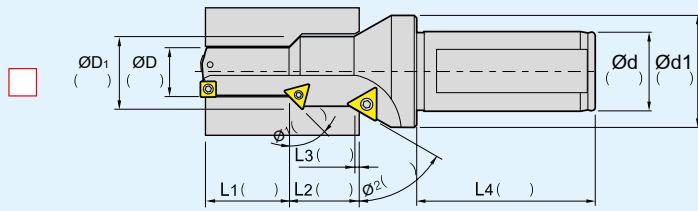
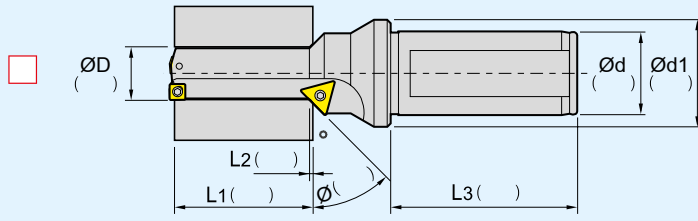
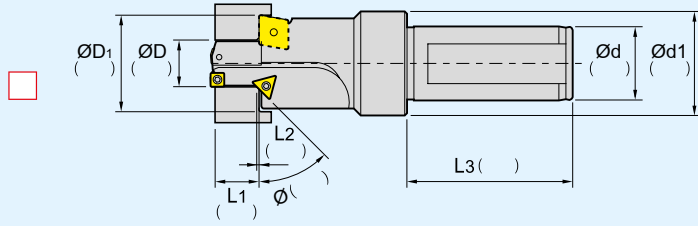

• Soğutma Tipi / Coolant type / Тип охлаждения

Yağ Deliği Dalma Kismında
Oil Hole On the Plunge Part
Боковая подача СОЖ

Yağ Deliği Şaft Kismında
"Oil hole On the Shank"
Подача СОЖ через хвостовик

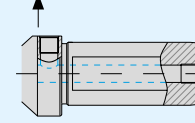

• Delik Tipi / Hole Type / Тип отверстия

Kapalı Delik
Blind Hole
Глухое отверстие

Açık Delik
Thru Hole
Сквозное отверстие

• Şaft Tipleri / Types of Shank / Типы хвостовика

Düz Tip
Flat Type
Цилиндрический хвостовик

Weldon Tip
Weldon Type
Хвостовик "Weldon"

Eğimli Yargı Tipi
Whistle Notch Type
Хвостовик с лыской

• Yargı Bağlama Yeri / Location of Side Lock / Расположение лыски хвостовика

Dış Uca Parellel (Standart)
Parallel to Peripheral Insert (Standard)
Стандартное – параллельно гнезду с внешней стороны пластины

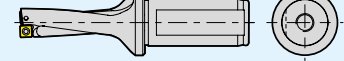

Dış Uca 90° Açılı
90° angle to peripheral insert
Угол 90° к периферийной вставке

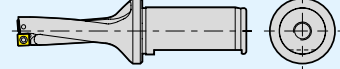

Dış Uca 150° Açılı
150° angle to peripheral insert
Угол 150° к периферийной вставке

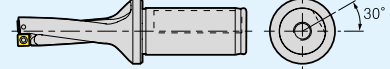

Dış Uca 180° Açılı
180° angle to peripheral insert
Угол 180° к периферийной вставке

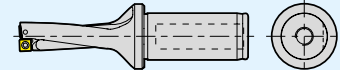

• Not / Note / Примечание :

- Şu Anki Kullanılan Takım / Currently Using Tool
- Инструменты, которые используются в настоящее время
- Şu Anki Kesme Durumu / Current Cutting Condition
- Режимы резания
 - RPM ya da vc(m/min) / - RPM or vc(m/min)
 - RPM или Vp(м/мин)
 - vf(mm/min) ya da fn(mm/rev)
 - vf(mm/min) or fn(mm/rev)
 - Kesme Derinliği / Depth of Cut(mm)
 - Глубина резания (мм)
- Ölçülen Standart Takım Ömrü / Standard of Measuring Tool Life
- Стандартный срок службы инструмента
- Şu Anki Kullanılan Makinalar / Currently Using Machine
- Станок, который используется в настоящее время
 - İşleme Merkezi / Machining Center
 - Обрабатывающий центр
 - Genel Torna / General Lathe
 - Общий токарный станок
 - CNC Torna / CNC Lathe
 - Станок с ЧПУ

konusulan
the spoken *kalite...*
quality...





*konusulan
the spoken kalite...
quality...*

EKONOMİK KESİCİLER

EKONOMİK KESİCİLER
ECONOMIC CUTTING TOOLS
ЭКОНОМИЧНЫЙ MULTI TOOL



AKKO **A** **EK** **R** - **D2.25** x **20**

X **C** **.** **.** **10** **T3** **04**

2 Kesiş Stili / Cutter Style / Тип режущего инструмента

EK : Ekonomik Kesici / Economic Cutting
Экономичное точение

3 Kesme Yönu / Cutting Direction / Направление резания

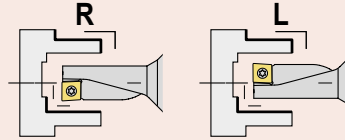

11 Kalınlık / Thickness / Толщина

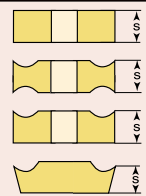

01	s = 1.59
T1	s = 1.98
02	s = 2.38
T2	s = 2.78
03	s = 3.18
T3	s = 3.97
04	s = 4.76
05	s = 5.56
06	s = 6.35
07	s = 7.94
09	s = 9.52

4 Delme Derinliđi / Drilling Depth / Глубина сверления

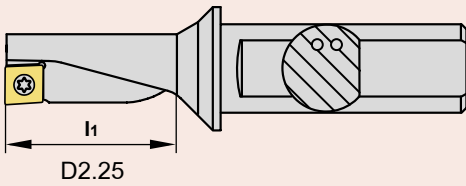

5 Takım Çarı / Tool Diameter / Диаметр режущей части

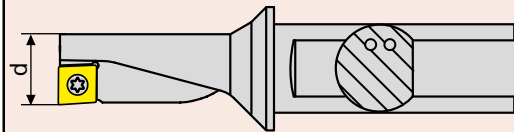

6 Uç Şekli / Insert Form / Вставить форму



X



Q

7 Serbest Uç Açısı / Clearance Angle of Insert / Задний угол пластины

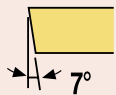

C

8 Toleranslar / Tolerance Classes / Классы толерантности

	d	m	t
A	± 0.025	± 0.005	± 0.025
C	± 0.025	± 0.013	± 0.025
E	± 0.025	± 0.025	± 0.025
F	± 0.013	± 0.005	± 0.025
G	± 0.025	± 0.025	± 0.130
H	± 0.013	± 0.013	± 0.025
J	± 0.05-0.15	± 0.005	± 0.025
K	± 0.05-0.15	± 0.013	± 0.025
L	± 0.05-0.15	± 0.025	± 0.025
M	± 0.05-0.15	± 0.08-0.20	± 0.130
N	± 0.05-0.15	± 0.08-0.20	± 0.025
U	± 0.08-0.25	± 0.13-0.38	± 0.130

d : Daire Ölçüsü / Inscribed Circle
m : Şekle Göre / Refer to Figure
t : Kalınlık / Thickness

9 Uç Tipi / Type of Insert / Форма пластины

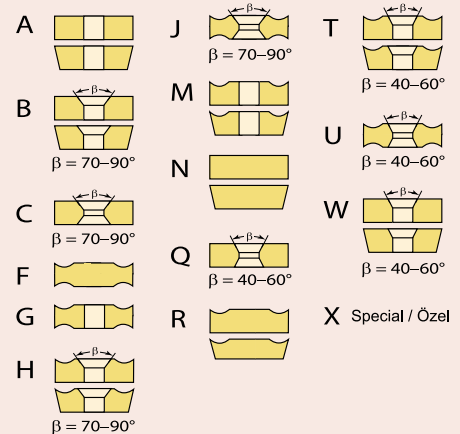

10 Kesme Kenar Uzunluđu / Cutting Edge Length / Длина режущей кромки

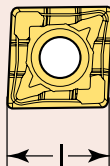

12 Köşe Konfigürasyonu / Corner Radius / Угловой радиус

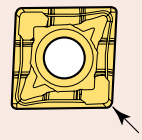

01	r = 0.1	12	r = 1.2
02	r = 0.2	16	r = 1.6
04	r = 0.4	24	r = 2.4
08	r = 0.8		

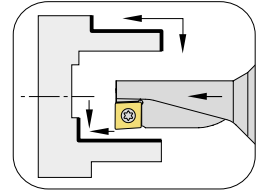
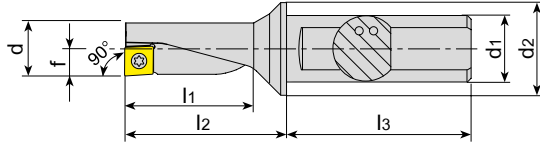

Takım Kodu Ordering Code Код для заказа	Stok Stock Наличие		Takım Ölçüleri (mm) Dimension (mm) Размеры (мм)							Kesici Uç Insert Пластина	Yedek Parçaları / Spare Parts / Запасные части	
	R	L	d	d1	d2	l1	l2	l3	f	Sıkma Vidası Screw Зажимной винт	Tork Anahtar Torx Key Торх Ключ	
AEKR/L-D2.25X8 XC.. 040104	●	●	8	10	12	18	22	38	4			80-T06
AEKR/L-D2.25X10 XC.. 050204	●	●	10	12	16	22.5	27.5	42	5			
AEKR/L-D2.25X12 XC.. 060204	●	●	12	16	20	27	33	45	6			80-T07
AEKR/L-D2.25X14 XC.. 070304	●	●	14	16	20	31.5	38	45	7			80-T08
AEKR/L-D2.25X16 XC.. 080304	●	●	16	20	25	36	44	50	8			
AEKR/L-D2.25X18 XC.. 09T304	●	●	18	25	32	40.5	53.5	56	9			80-T15
AEKR/L-D2.25X20 XC.. 10T304	●	●	20	25	32	45	55	56	10			
AEKR/L-D2.25X25 XC.. 130404	●	●	25	32	40	56.5	69	60	12.5			80-T20
AEKR/L-D2.25X32 XC.. 170504	●	●	32	32	50	72	88	60	16			

R: Sağ / Right / Правый L: Sol/Left/Левый
 ● Stokta / In Stock / В наличии ○ Stokta Yok / Non Stock Item / Нет в наличии
 CRTZT-ISCR-TGTC-KRLY Ucuna Uygundur. / Compatible with CRTZT-ISCR-TGTC-KRLY Insert.
 Под пластину CRTZT-ISCR-TGTC-KRLY

Sipariş Örneği/Ordering Example/Образец заказа
 1 ad./pcs./шт AEKR-D2.25X8 XC.. 040104

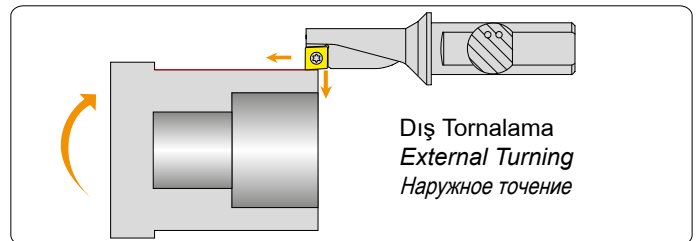
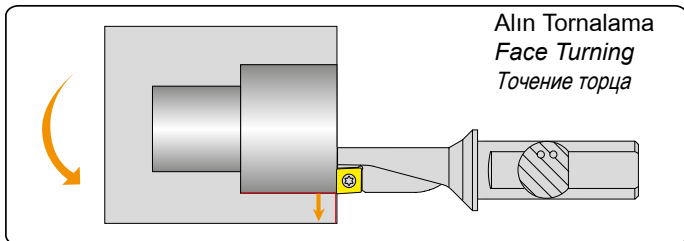
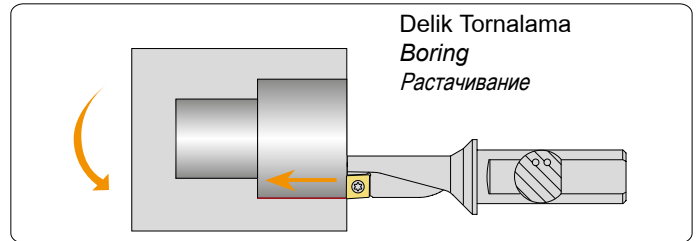
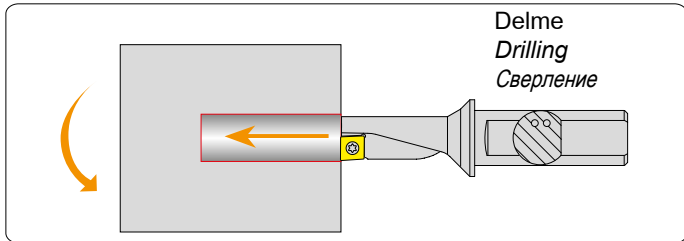
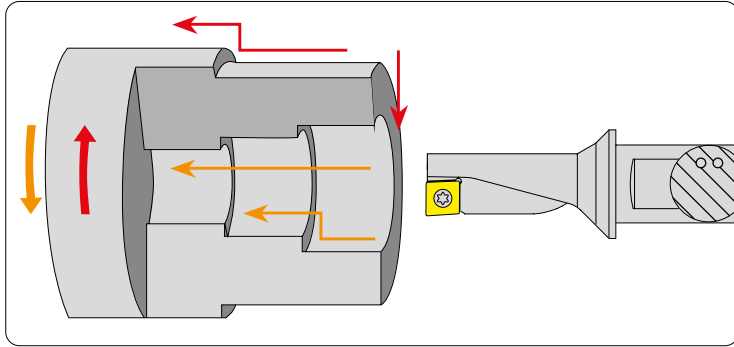

BARALAR

AYARLI DELİK İŞLEME BARALARI

ADJUSTABLE BORING HEADS

РЕГУЛИРУЕМЫЕ РАСТОЧНЫЕ ГОЛОВКИ

konusulan
the spoken kalite...
quality...



AKKO **A** **BH** **R** - **D18x22**

W16 - **L90** - **CC06**

2 Kesiş Stili / Cutter Style / Тип режущего инструмента

BH : Delik İşleme / Boring Head
Расточная головка

3 İşlem Tipi / Cutter Type / Виды растачивания

R : Kaba Baralama / Rough Boring
Черновое точение
F : Hassas Baralama / Fine Boring
Чистовое точение

5 Montaj Formu / Assembly Form / Тип хвостовика

W : Weldon

4 Ölçü Aralığı / Boring Range / Диаметр растачивания

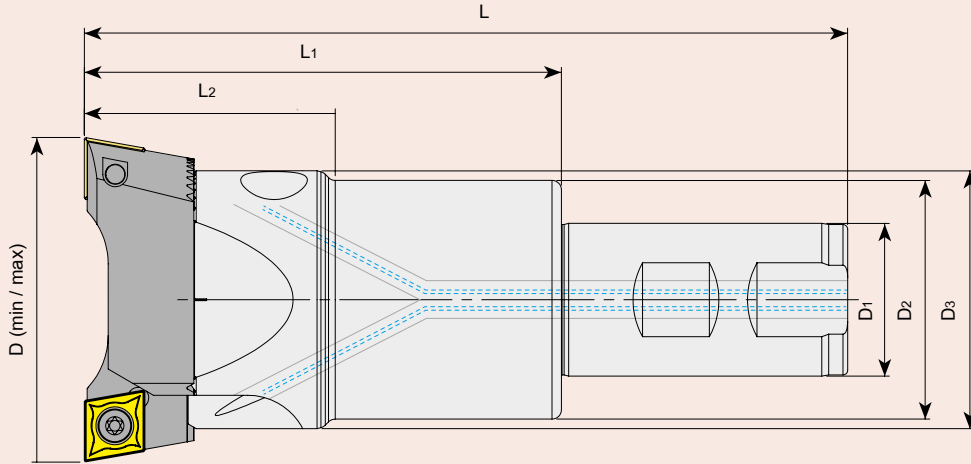

6 Takım Boyu / Tool Length / Длина инструмента

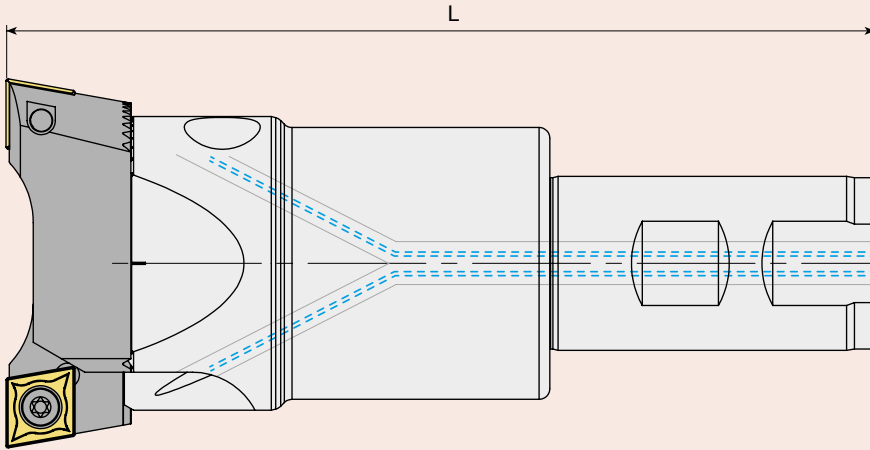

7 Kesici Uç / Insert / Пластина

CC06 : CC.. 0602..
CC09 : CC.. 09T3..
CC12 : CC.. 1204..

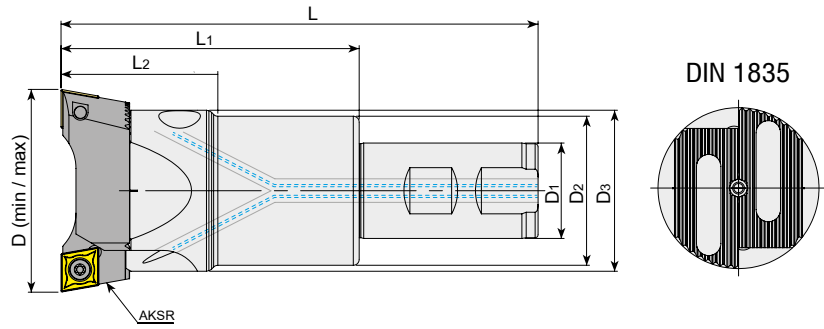

Takım Kodu Ordering Code Код для заказа	Stok Stock Наличие	Ölçü Aralığı Boring Range D (min/max)	Takım Ölçüleri (mm) Dimension (mm) Размеры (мм)						Kartuş Cartridge картридж	Bara Gövde Takım Kodu Boring Head Body Code Код Корпуса Для Регулируемых Расточных Головок
			D ₁	D ₂	D ₃	L	L ₁	L ₂		
ABHR-D18x22-W16-L90-CC06	●	18-22	16	-	-	90	42	-	AK.. 18-22	ABHRS-D16x42-W16-L90
ABHR-D18x22-W16-L150-CC06	●	18-22	16	-	-	150	102	-		ABHRS-D16x102-W16-L150
ABHR-D18x22-W16-L200-CC06	●	18-22	16	-	-	200	152	-		ABHRS-D16x152-W16-L200
ABHR-D22x28-W20-L100-CC06	●	22-28	20	-	-	100	50	-	AK.. 22-28	ABHRS-D20x50-W20-L100
ABHR-D22x28-W20-L150-CC06	●	22-28	20	-	-	150	100	-		ABHRS-D20x100-W20-L150
ABHR-D22x28-W20-L200-CC06	●	22-28	20	-	-	200	150	-		ABHRS-D20x150-W20-L200
ABHR-D28x38-W20-L110-CC06	●	28-38	20	25	-	110	60	-	AK.. 28-38	ABHRS-D25x60-W20-L110
ABHR-D28x38-W20-L160-CC06	●	28-38	20	25	-	160	110	-		ABHRS-D25x110-W20-L160
ABHR-D28x38-W20-L230-CC06	●	28-38	20	25	-	230	180	-		ABHRS-D25x180-W20-L230
ABHR-D36x50-W25-L120-CC06	●	36-50	25	32	-	120	64	-	AK.. 36-50	ABHRS-D32X64-W25-L120
ABHR-D36x50-W25-L170-CC06	●	36-50	25	32	-	170	114	-		ABHRS-D32X114-W25-L170
ABHR-D36x50-W25-L250-CC06	●	36-50	25	32	-	250	194	-		ABHRS-D32X194-W25-L250
ABHR-D36x50-W25-L120-CC09	●	36-50	25	32	-	120	64	-	AK.. 36-50-09	ABHRS-D32X64-W25-L120
ABHR-D36x50-W25-L170-CC09	●	36-50	25	32	-	170	114	-		ABHRS-D32X114-W25-L170
ABHR-D36x50-W25-L250-CC09	●	36-50	25	32	-	250	194	-		ABHRS-D32X194-W25-L250
ABHR-D50x68-W32-L140-CC09	●	50-68	32	40	-	140	80	-	AK.. 50-68	ABHRS-D40x80-W32-L140
ABHR-D50x68-W32-L200-CC09	●	50-68	32	40	-	200	140	-		ABHRS-D40x140-W32-L200
ABHR-D50x68-W32-L280-CC09	●	50-68	32	40	-	280	220	-		ABHRS-D40x220-W32-L280
ABHR-D50x68-W32-L140-CC12	●	50-68	32	40	-	140	80	-	AK.. 50-68-12	ABHRS-D40x80-W32-L140
ABHR-D50x68-W32-L200-CC12	●	50-68	32	40	-	200	140	-		ABHRS-D40x140-W32-L200
ABHR-D50x68-W32-L280-CC12	●	50-68	32	40	-	280	220	-		ABHRS-D40x220-W32-L280
ABHR-D68x90-W32-L160-CC12	●	68-90	32	50	54	160	100	50	AK.. 68-90	ABHRS-D50x100-W32-L160
ABHR-D68x90-W32-L210-CC12	●	68-90	32	50	54	210	150	50		ABHRS-D50x150-W32-L210
ABHR-D68x90-W32-L280-CC12	●	68-90	32	50	54	280	220	50		ABHRS-D50x220-W32-L280
ABHR-D90x120-W32-L140-CC12	●	90-120	32	63	72	140	80	63	AK.. 90-120	ABHRS-D63x80-W32-L140
ABHR-D90x120-W40-L200-CC12	●	90-120	40	63	72	200	130	63		ABHRS-D63x130-W40-L200
ABHR-D90x120-W40-L300-CC12	●	90-120	40	63	72	300	230	63		ABHRS-D63x230-W40-L300
ABHR-D120x160-W40-L210-CC12	●	120-160	40	80	95	210	140	75	AK.. 120-160	ABHRS-D80x140-W40-L210
ABHR-D120x160-W40-L300-CC12	●	120-160	40	80	95	300	230	75		ABHRS-D80x230-W40-L300
ABHR-D160x200-W40-L210-B-CC12	●	160-200	40	80	95	210	140	75	AK.. 160-800	ABHRS-D80x140-W40-L210
ABHR-D160x200-W40-L300-B-CC12	●	160-200	40	80	95	300	230	75		ABHRS-D80x230-W40-L300

R: Sağ / Right / Правый L: Sol/Left/Левый
 ● Stokta / In Stock / В наличии ○ Stokta Yok / Non Stock Item / Нет в наличии
 Siparişte, gövde ve kartuş set olarak verilecektir. / When ordered, body and cartridge will be sent as set.
 Картриджи поставляются в комплекте

Sipariş Örneği/Ordering Example/Образец заказа
 1 ad./pcs./шт ABHR-D18x22-W16-L90-CC06

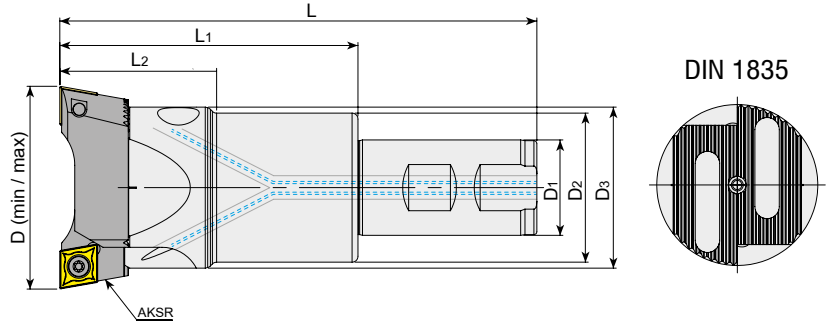

Yedek Parçaları / Spare Parts / Запасные части

Takım Kodu Ordering Code Код для заказа	Stok Stock Наличие	Ölçü Aralığı Boring Range D (min/max)	Takım Ölçüleri (mm) Dimension (mm) Размеры (мм)						Montaj Vidası Mounting Screw Монтажный винт	Montaj Vida Anahtarı Allen Key Монтажный винт	Pabuç Clamp Прижим	Ayar Vidası Adjusting Screw Регулировочный винт	Ayar Vida Anahtarı Allen Key Торцевой ключ
			D ₁	D ₂	D ₃	L	L ₁	L ₂					
ABHRS-D16x42-W16-L90	●	18-22	16	-	-	90	42	-					
ABHRS-D16x102-W16-L150	●	18-22	16	-	-	150	102	-	2525-M3x14	AAL-02-2.5	ABKS-D16	2715-M3x4	
ABHRS-D16x152-W16-L200	●	18-22	16	-	-	200	152	-					
ABHRS-D20x50-W20-L100	●	22-28	20	-	-	100	50	-					
ABHRS-D20x100-W20-L150	●	22-28	20	-	-	150	100	-	2503-M4x15	AAL-03-3	ABKS-D20	2715-M3x5	AAL-09-1.5
ABHRS-D20x150-W20-L200	●	22-28	20	-	-	200	150	-					
ABHRS-D25x60-W20-L110	●	28-38	20	25	-	110	60	-					
ABHRS-D25x110-W20-L160	●	28-38	20	25	-	160	110	-	2503-M4x20	AAL-03-3	ABKS-D25	2715-M3x8	
ABHRS-D25x180-W20-L230	●	28-38	20	25	-	230	180	-					
ABHRS-D32X64-W25-L120	●	36-50	25	32	-	120	64	-					
ABHRS-D32X114-W25-L170	●	36-50	25	32	-	170	114	-	2504-M5x25	AAL-05-4	ABKS-D32	2702-M4x12	AAL-01-2
ABHRS-D32X194-W25-L250	●	36-50	25	32	-	250	194	-					
ABHRS-D40x80-W32-L140	●	50-68	32	40	-	140	80	-					
ABHRS-D40x140-W32-L200	●	50-68	32	40	-	200	140	-	2505-M6x30	AAL-07-5	ABKS-D40	2725-M5x14	
ABHRS-D40x220-W32-L280	●	50-68	32	40	-	280	220	-					AAL-02-2.5
ABHRS-D50x100-W32-L160	●	68-90	32	50	54	160	100	50					
ABHRS-D50x150-W32-L210	●	68-90	32	50	54	210	150	50	2506-M8x35	AAL-08-6	ABKS-D50	2725-M5x12	
ABHRS-D50x220-W32-L280	●	68-90	32	50	54	280	220	50					
ABHRS-D63x80-W32-L140	●	90-120	32	63	72	140	80	63					
ABHRS-D63x130-W40-L200	●	90-120	40	63	72	200	130	63	2508-M10x40	AAL-11-8	ABKS-D63	2703-M6x16	AAL-03-3
ABHRS-D63x230-W40-L300	●	90-120	40	63	72	300	230	63					
ABHRS-D80x140-W40-L210	●	120-160	40	80	95	210	140	75	2510-M12x40	AAL-12-10	ABKS-D80	2704-M8x25	AAL-05-4
ABHRS-D80x230-W40-L300	●	120-160	40	80	95	300	230	75					
ABHRS-D80x140-W40-L210	●	160-200	40	80	95	210	140	75	2510-M12x40				
ABHRS-D80x230-W40-L300	●	160-200	40	80	95	300	230	75					

R: Sağ / Right / Правый L: Sol/Left/Левый

● Stokta / In Stock / В наличии ○ Stokta Yok / Non Stock Item / Нет в наличии

Sipariş Örneği/Ordering Example/Образец заказа

1 ad./pcs./шт ABHRS-D16x42-W16-L90

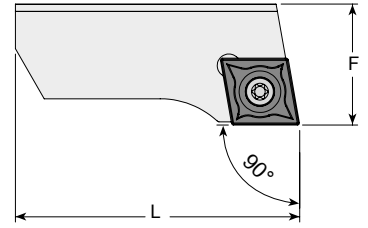

Takım Kodu Ordering Code Код для заказа	Stok Stock Наличие	Takım Ölçüleri (mm) Dimension (mm) Размеры (мм)		Kesici Uç Insert Пластина	Yedek Parçaları / Spare Parts / Запасные части		
		Ölçü Aralığı Boring Range	F		L	Sıkma Vidası Screw Зажимной винт	Tork Anahtar Torx Key Торх Ключ
AKSR 18-22	●	18-22	9	15	CC.. 0602..	4008-M2.5x6	80-T08
AKSR 22-28	●	22-28	10	19			
AKSR 28-38	●	28-38	13	23			
AKSR 36-50	●	36-50	16	32	CC.. 09T3..	4015-M3.5x8	80-T15
AKSR 36-50-09	●	36-50	16	32			
AKSR 50-68	●	50-68	20	40			
AKSR 50-68-12	●	50-68	20	40	CC.. 1204..	1020-M5x11	80-T20
AKSR 68-90	●	68-90	23	54			
AKSR 90-120	●	90-120	28	70			
AKSR 120-160	●	120-160	32	95			
AKSR 160-800	●	160-800	32	120			

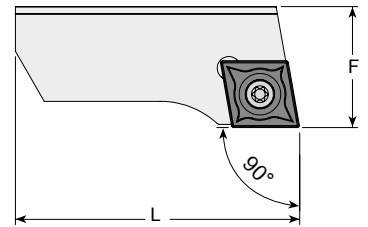

Takım Kodu Ordering Code Код для заказа	Stok Stock Наличие	Takım Ölçüleri (mm) Dimension (mm) Размеры (мм)		Kesici Uç Insert Пластина	Yedek Parçaları / Spare Parts / Запасные части		
		Ölçü Aralığı Boring Range	F		L	Sıkma Vidası Screw Зажимной винт	Tork Anahtar Torx Key Торх Ключ
AKCR 28-38	●	28-38	12.8	23	CC.. 0602..	4008-M2.5x6	80-T08
AKCR 36-50	●	36-50	15.8	32			
AKCR 36-50-09	●	36-50	15.8	32			
AKCR 50-68	●	50-68	19.7	40	CC.. 09T3..	4015-M3.5x8	80-T15
AKCR 50-68-12	●	50-68	19.7	40			
AKCR 68-90	●	68-90	22.7	54			
AKCR 90-120	●	90-120	27.7	70	CC.. 1204..	1020-M5x11	80-T20
AKCR 120-160	●	120-160	31.7	95			
AKCR 160-800	●	160-800	31.7	120			

R: Sağ / Right / Правый L: Sol/Left/Левый
● Stokta / In Stock / В наличии ○ Stokta Yok / Non Stock Item / Нет в наличии
ISO Ucuna Uygunudur. / Compatiple with ISO Insert. / Под пластину ISO

Sipariş Örneği/Ordering Example/Образец заказа
1 ad./pcs./шт AKSR 18-22

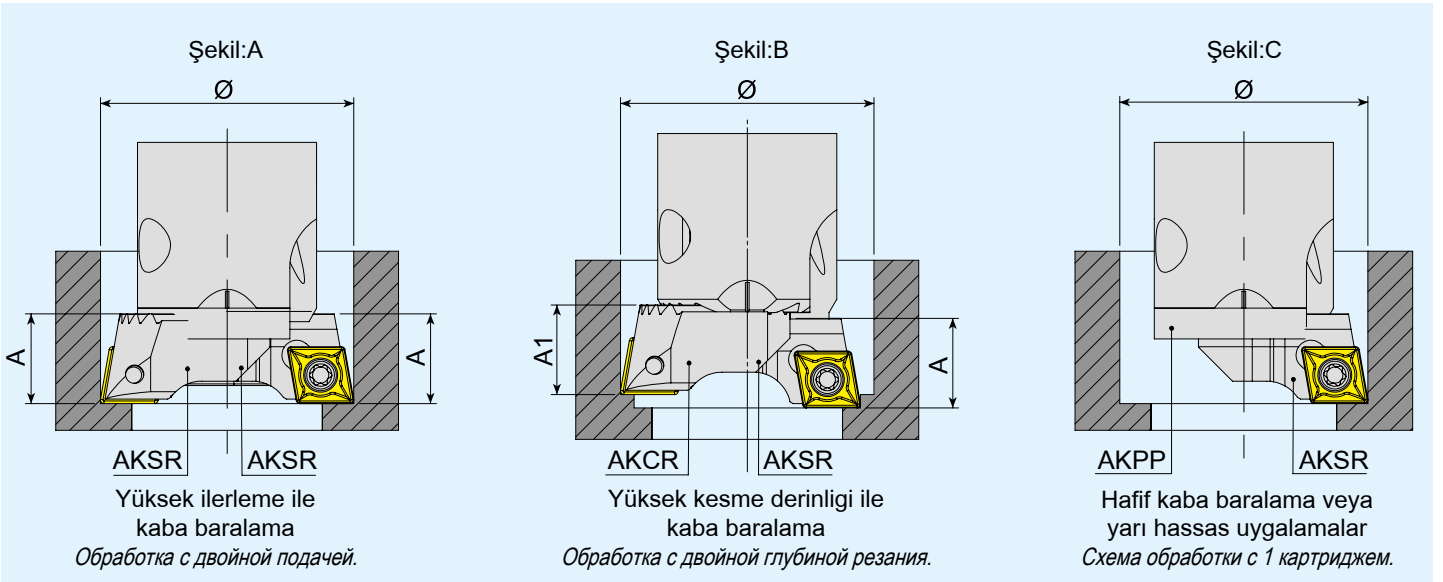

1. Kesici kenarların radyal ayarı, takım ölçme ekipmanı ile yapılmalıdır.
2. İki uçlu baralama takımı, ağır talaş kaldırma işlemini içeren kaba baralama işlemleri içindir. Çift uçlu baralama takımı ile:
 - Yüksek ilerleme oranında kaba baralama işlemleri için, aynı düzlemdeki iki AKSR kartuşu, aynı radyal mesafeye ayarlanır. (Şekil A)
 - Aynı düzlemde olmayan bir AKCR kartuşu ve bir AKSR kartuşu yüksek derinlikte kaba baralama işlemleri için kullanılır. (Şekil B)
 - i. Kaba baralama işleminde, alınacak paso miktarı tam olarak ikiye bölünüp, düzgün bir kesim sağlanmış olur, ancak bu durumda tur başına ilerleme tek ağız olarak hesaplanmalıdır. ($f=f_1$)
 - ii. Hassas baralama işleminde, alınacak paso miktarı AKSR kartuş için ara kaba olarak ve AKCR kartuş için hassas bara olarak çaplar ayarlanır ve bu sayede bazı ara kaba işleme ihtiyacı kalmaz.
3. Tek kartuşlu baralama takımları, normal talaş kaldırma işlemini içeren kaba ve hassas baralama işlemleri içindir. Dişleri koruma plakası, AKPP daima kullanılmalıdır. (Şekil C)

1. Radial setting of the cutting edges should be carried out with tool presetting equipment.
2. Boring bars fitted with two insert pockets are for roughing operations involving heavy chip removal. The double-insert boring bars include:
 - Two AKSR cartridges on the same plane with two cutting edges set at identical radial distance for high feed rate roughing operations. (fig. A)
 - An AKCR cartridge and an AKSR cartridge not on the same plane for high-depth roughing operations. (fig. B)
 - i. With the rough boring operation, this allows double the cutting width, using only a single feed rate. ($f=f_1$)
 - ii. With the finish boring operation, the cutting width is divided so that some of the intermediate machining can be omitted.
3. Boring bars fitted with a single cartridge are for roughing and finishing operations involving normal chip removal. The serrated surface protection plate AKPP should always be used (fig. C)

1. Радиальная установка резцов должна быть выполнена на приборе по предварительной настройке инструмента вне станка.
2. Двурезцовые расточные головки предназначены для высокопроизводительной черновой обработки. Три схемы сборки:
 - Рисунок А: два картриджа AKSR... устанавливаются в одной плоскости на один диаметр. Это обеспечивает двойную подачу при черновой обработке.
 - Рисунок В: 2 различных картриджа AKSR... и AKCR... устанавливаются с разными вылетами. Это обеспечивает двойную глубину резания.
 - i. Подача устанавливается одна и должна быть не более разницы вылетов A и A1.
 - ii. Распределение припуска по картриджам должно быть равномерным.
3. Рисунок С: используется один из картриджей AKSR... или AKCR..., а так же заглушка AKPP....



*konusulan
the spoken kalite...
quality...*

FREZELEME TAKIMLARI
MILLING TOOLS
ФРЕЗЕРНЫЙ ИНСТРУМЕНТ



AKKO
A
1

EM
2

90
3

L
4

- A
5

P
6

10
7

D12
8

- W16
9

- L100
10

- Z01
11

- H
12

2 Kesiş Stili / Cutter Style / Тип режущего инструмента

FM: Yüzey Frezeleme Takımları / Face Milling Tools / Торцевые Фрезы
EM: Alın ve Yüzey Parmak Frezeleri / End Face Milling Tools / Торцевые Фрезы
CM: Pah Kırma Parmak Frezeleri / Chamfering End Milling Tools / КОНЦЕВЫЕ СПИРАЛЬНЫЕ ФРЕЗЫ ДЛЯ СНЯТИЯ ФАСКИ
HM: Helis Parmak Frezeleri / Helix End Milling Tools / КОНЦЕВЫЕ ФРЕЗЫ ДЛЯ СНЯТИЯ ФАСКИ
TSM: T Kanal Frezeleri / T Slot Milling Tools / Т-ОБРАЗНЫЕ ФРЕЗЫ
HFM: Yüksek İlerleme Frezeleme Takımları / High Feed Milling Tools / ВЫСОКОПРОИЗВОДИТЕЛЬНЫЕ КОНЦЕВЫЕ ФРЕЗЫ
PMR: Küresel Uçlu Parmak Frezeleri / Ball Nose End Milling Tools / СФЕРИЧЕСКИЕ КОНЦЕВЫЕ ФРЕЗЫ
SDM: Disk Frezeler / Slot Disc Milling / ДИСКОВЫЕ ТРЕХСТОРОННИЕ ФРЕЗЫ
CBM: Silindirik Aylan Başlı Vida Havşalarını Açma Frezeleri / Countersink Milling Tool for Cylindrical Allen Head Screws
ZENKOVKA DLA OTVERSTIY POD VINTY S CILINDRICHESKOY I SHESTIGRANNOY GOLONKOY (GOST 974-1)

3 Freze Yanaşma Açısı / Lead Angle / Угол направления

90° - 75° - 60° - 45°
20° - 15° - 11° - 5° - 0°

4 Freze Yanaşma Açısı / Lead Angle / Угол направления

L: Sol - Left / Левая сторона
C: Baskı Pabuçu - Clamp / Прихват
S: Altlık - Shim / опорными пластинами
CL: Baskı Pabuçlu Sol Yön - Left Way with Clamp
Левое вращение, крепление СМП прихватом
CS: Baskı Pabuçlu Altlıklı - Clamp with Shim
Крепление СМП прихватом, с опорными пластинами
CSL: Baskı Pabuçlu Altlıklı Sol Yön - Left Way Clamp with Shim
Левое вращение, крепление СМП прихватом, с опорными пластинами

5 Uç Tipi / Type of Insert / Форма пластины

C	D	E	K
L	R	S	T
V	W	A	B
H	M	O	P

6 Serbest Uç Açısı / Clearance angle of Insert / Задний угол пластины

A	B	C
D	E	F
G	N	P

7 Kesme Kenar Uzunluğu / Cutting Edge Length / Длина режущей кромки

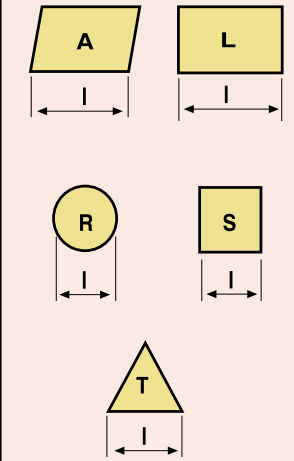

8 Takım Çapı / Tool Diameter / Диаметр режущей части

9 Montaj Formu ve Çapı / Assembly Form and Diameter / Тип сборки и диаметр

A, B, C, D: ISO'ya göre montaj formu / Assembly Form and Diameter / Под ISO A, B, C, D Тип сборки
C: Silindirik Şaft / Cylindrical Shank
W: Weldon

10 Takım Boyu / Tool Length / Длина инструмента

11 Etkili Diş Adedi / Number of Effective Tooth / Количество эффективных зубов

12 İçten Soğutmalı / With Coolant Hole / С охлаждающим отверстием

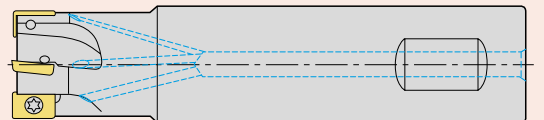

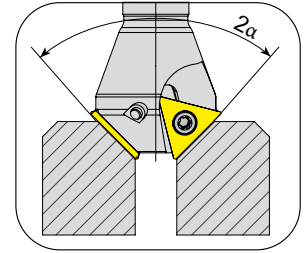
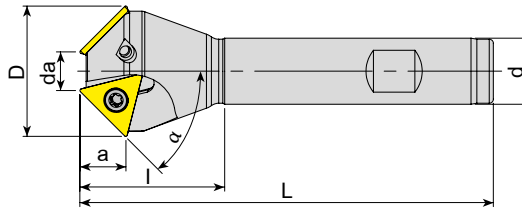

Takım Kodu Ordering Code Код для заказа	Stok Stock Наличие	Takım Ölçüleri (mm) Dimension (mm) Размеры (мм)								Kesici Uç Insert Пластина	Yedek Parçaları / Spare Parts / Запасные части		
		α	da	D	d	L	l	Z	a		Sıkma Vidası Screw Зажимной винт	Tork Anahtar Torx Key Торх Ключ	
ACM10-TC16-D17X22-W16-L90-Z01	●	10°	17	22	16	90	30	1	15.2	TC.T 16T304	4015-M3.5x9	80-T15	
ACM15-TC16-D17X24-W16-L90-Z01	●	15°	17	24	16	90	30	1	14.9				
ACM15-TC16-D22X29-W16-L100-Z01	●	15°	22	29	16	100	30	1	14.9				
ACM15-TC16-D30X37-W20-L100-Z02	●	15°	30	37	20	100	35	2	14.9				
ACM15-TC16-D35X42-W20-L100-Z03	●	15°	35	42	20	100	38	3	14.9				
ACM15-TC16-D52X59-W25-L110-Z03	●	15°	52	59	25	110	40	3	14.9				
ACM17.5-TC16-D17X25-W16-L90-Z01	●	17.5°	17	25	16	90	30	1	14.7				
ACM18.5-TC16-D21.3X30-W20-L100-Z02	●	18.5°	21.3	30	20	100	30	2	13.5				TC.T 16T308
ACM20-TC16-D12X22-W16-L100-Z01	●	20°	12	22	16	100	30	1	14.4				
ACM20-TC16-D17X27-W16-L100-Z01	●	20°	17	27	16	100	30	1	14.4				
ACM20-TC16-D23X33-W20-L100-Z02	●	20°	23	33	20	100	30	2	14.4				
ACM20-TC16-D28X38-W20-L100-Z02	●	20°	28	38	20	100	35	2	14.4				
ACM20-TC16-D35X45-W20-L100-Z03	●	20°	35	45	20	100	40	3	14.4	TC.T 16T304			
ACM20-TC16-D39X49-W20-L100-Z03	●	20°	39	49	20	100	40	3	14.4				
ACM20-TC16-D45X55-W25-L110-Z03	●	20°	45	55	25	110	40	3	14.4				
ACM20-TC16-D51X61-W25-L110-Z03	●	20°	51	61	25	110	40	3	14.4				
ACM22.5-TC16-D17X28-W16-L100-Z01	●	22.5°	17	28	16	100	30	1	14.2				
ACM25-TC16-D17X29-W16-L100-Z01	●	25°	17	29	16	100	30	1	13.9				
ACM30-TC16-D6X20-W16-L100-Z01	●	30°	6	20	16	100	30	1	13.3				
ACM30-TC16-D15X30-W16-L100-Z01	●	30°	15	30	16	100	30	1	13.3				
ACM30-TC16-D17.5X32.5-W20-L100-Z02	●	30°	17.5	32.5	20	100	30	2	13.3				
ACM30-TC16-D20X35-W16-L100-Z02	●	30°	20	35	16	100	35	2	13.3				
ACM30-TC16-D30X45-W20-L100-Z02	●	30°	30	45	20	100	40	2	13.3				
ACM30-TC16-D35X50-W20-L100-Z03	●	30°	35	50	20	100	40	3	13.3				
ACM30-TC16-D45X60-W25-L110-Z03	●	30°	45	60	25	110	40	3	13.3				
ACM45-TC09-D7X18-W16-L100-Z02	●	45°	7	18	16	100	25	2	5.9	TC.T 090204	3007-M2.2x5	80-T07	
ACM45-TC11-D11X24-W16-L100-Z02	●	45°	11	24	16	100	25	2	6.9	TC.T 110204	3008-M2.5x6	80-T08	
ACM45-TC16-D5X26-W16-L100-Z01	●	45°	5	26	16	100	30	1	10.8	TC.T 16T304	4015-M3.5x9	80-T15	
ACM45-TC16-D10X31-W16-L100-Z02	●	45°	10	31	16	100	35	2	10.8				
ACM45-TC16-D10X31-W20-L100-Z02	●	45°	10	31	20	100	35	2	10.8				
ACM45-TC16-D18X39-W16-L100-Z02	●	45°	18	39	16	100	40	2	10.8				
ACM45-TC16-D18X39-W20-L100-Z02	●	45°	18	39	20	100	40	2	10.8				
ACM45-TC16-D20X41-W20-L100-Z02	●	45°	20	41	20	100	40	2	10.8				
ACM45-TC16-D30X51-W20-L100-Z02	●	45°	30	51	20	100	40	2	10.8				
ACM55-TC16-D16X40-W20-L100-Z03	●	55°	16	40	20	100	40	3	8.7				
ACM62-TC16-D14X40-W20-L100-Z03	●	62°	14	40	20	100	40	3	7.1				
ACM72-TC16-D14X42-W20-L100-Z03	●	72°	14	42	20	100	40	3	4.6				

➤ **S-SİSTEM PAH FREZELER**
S-SYSTEM CHAMFERING END MILLS
S-ТИП КОНЦЕВЫЕ ФРЕЗЫ ДЛЯ СНЯТИЯ ФАСКИ (ЗЕНКОВКИ)

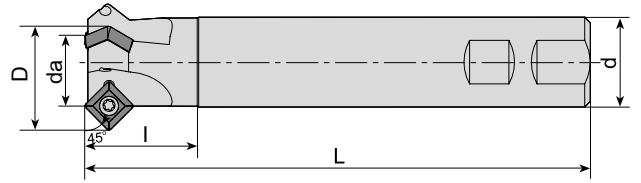

Takım Kodu Ordering Code Код для заказа	Stok Stock Наличие	Takım Ölçüleri (mm) Dimension (mm) Размеры (мм)								Kesici Uç Insert Пластина	Yedek Parçaları / Spare Parts / Залпасные части	
		α	da	D	d	L	l	Z	a		Sıkma Vidası Screw Зажимной винт	Tork Anahtar Torx Key Торх Ключ
ACM45-SP1104-D12x26-W20-L150-Z01	●	45°	12	26	20	150	30	1	-	SPGT 110408	4015-M4x9	80-T15
ACM45-SP1104-D25x39-W25-L150-Z02	●	45°	25	39	25	150	35	2	-			
ACM45-SP1104-D32x46-W32-L150-Z03	●	45°	32	46	32	150	40	3	-			

ZCC Ucuna Uygundur. / Compatible with ZCC Insert. / Под пластину ZCC

➤ **HELİS PAH FREZELEME TAKIMLARI**
HELIX CHAMFER MILLING TOOLS
СПИРАЛЬНЫЕ ФРЕЗЫ ДЛЯ СНЯТИЯ ФАСКИ

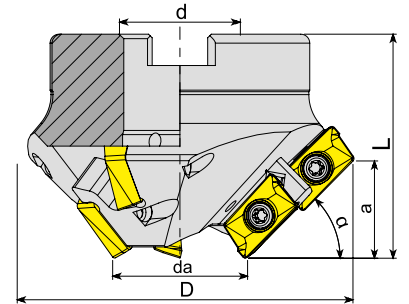

Takım Kodu Ordering Code Код для заказа	Stok Stock Наличие	Takım Ölçüleri (mm) Dimension (mm) Размеры (мм)								Kesici Uç Insert Пластина	Yedek Parçaları / Spare Parts / Залпасные части	
		Z		α	da	D	d	a	L		Sıkma Vidası Screw Зажимной винт	Tork Anahtar Torx Key Торх Ключ
		Toplam Total Общее	Etkili Effective Эффективное									
AHM15-AP16-D35x93-A27-Z0306-H	●	6	3	15	35	93	27	8	50	AP.. 1604..	4015-M4x11	80-T15
AHM30-AP16-D35x87-A27-Z0306-H	●	6	3	30	35	87	27	15	50			
AHM45-AP16-D35x77-A27-Z0306-H	●	6	3	45	35	77	27	21.5	50			
AHM60-AP16-D35x65-A22-Z0306-H	●	6	3	60	35	65	22	26.5	50			
AHM75-AP16-D35x50-A22-Z0306-H	●	6	3	75	35	50	22	29.5	50			

R: Sağ / Right / Правый L: Sol/Left/Левый
 ● Stokta / In Stock / В наличии ○ Stokta Yok / Non Stock Item / Нет в наличии
 ISO Ucuna Uygundur. / Compatible with ISO Insert. / Под пластину ISO

Sipariş Örneği/Ordering Example/Образец заказа
 1 ad./pcs./шт ACM45-SP1104-D12x26-W20-L150-Z01
 Kesme Hesabı : S 321 / Cutting Calculation : P 321 / Расчет режимов резания: стр. 321

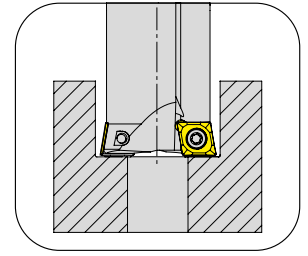
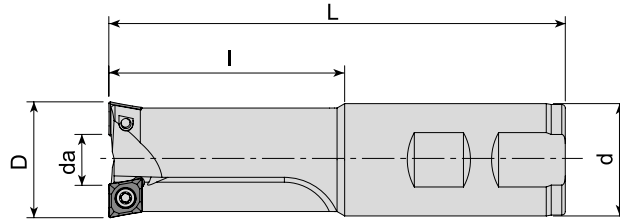

Takım Kodu
Ordering Code
 Код для заказа

Stok
 Stock
 Наличие

Takım Ölçüleri (mm)
 Dimension (mm)
 Размеры (мм)

Kesici Uç
 Insert
 Пластина

Yedek Parçaları / Spare Parts / Запасные части

Sıkma Vidası
 Screw
 Зажимной винт

Tork Anahtar
 Torx Key
 Торх Ключ

Takım Kodu Ordering Code Код для заказа	Stok Stock Наличие	da	D	d	l	L	Kullanılan Vidalar For Screws Используемые Винты	Kesici Uç Insert Пластина	Sıkma Vidası Screw Зажимной винт	Tork Anahtar Torx Key Торх Ключ
ACBM-CC06-D17X6-W16-L150-Z02	●	6	17	16	30	150	-	CC.. 060204	3008-M2.5x6	80-T08
ACBM-CC06-D18X7-W16-L100-Z02-H	●	7	18	16	32	100	M10			
ACBM-CC06-D18X7-W16-L160-Z02-H	●	7	18	16	32	160	M10			
ACBM-CC06-D20X9-W20-L100-Z02-H	●	9	20	20	40	100	M12			
ACBM-CC06-D20X9-W20-L160-Z02-H	●	9	20	20	38	160	M12	CC.. 09T304	4015-M3.5x9	80-T15
ACBM-CC09-D26X8.5-W25-L130-Z02-H	●	8.5	26	25	50	130	M16			
ACBM-CC09-D26X8.5-W25-L200-Z02-H	●	8.5	26	25	50	200	M16			
ACBM-CC09-D33X15.5-W32-L130-Z02-H	●	15.5	33	32	65	130	M20			
ACBM-CC09-D33X15.5-W32-L200-Z02-H	●	15.5	33	32	65	200	M20	SP.. 060204	3007-M2.2x5	80-T07
ACBM-SP06-D15X4-W16-L160-Z02-H	●	4	15	16	80	160	M8			

R: Sağ / Right / Правый L: Sol/Left/Левый
 ● Stokta / In Stock / В наличии ○ Stokta Yok / Non Stock Item / Нет в наличии
 ISO Ucuna Uygunudur. / Compatiple with ISO Insert. / Под пластину ISO

Sipariş Örneği/Ordering Example/Образец заказа
 1 ad./pcs./шт ACBM-CC06-D17X6-W16-L150-Z02
 Kesme Hesabı : S 321 / Cutting Calculation : P 321 / Расчет режимов резания: стр. 321



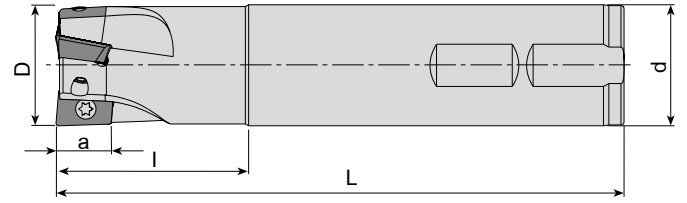

Takım Kodu Ordering Code Код для заказа	Stok Stock Наличие	Takım Ölçüleri (mm) Dimension (mm) Размеры (мм)						Kesici Uç Insert Пластина	Yedek Parçaları / Spare Parts / Запасные части		
		D	Z	d	L	l	a		Sıkma Vidası Screw Зажимной винт	Tork Anahtar Torx Key Торк Ключ	
AEM90-AD1505-D25-W25-L150-Z02	●	25	2	25	150	50	15	AD.. 1505..		4015-M4x9	
AEM90-AD1505-D30-W25-L150-Z03	●	30	3	25	150	40	15				
AEM90-AD1505-D32-W32-L150-Z03	●	32	3	32	150	50	15				

ISCR Ucuna Uygundur. / Compatible with ISCR Insert. / Под пластину ISCR

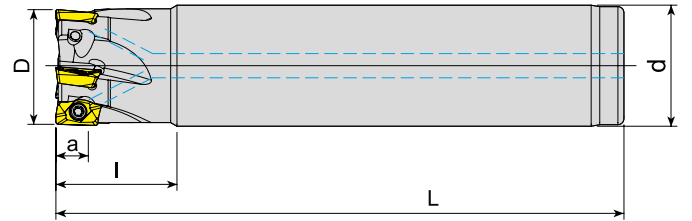

Takım Kodu Ordering Code Код для заказа	Stok Stock Наличие	Takım Ölçüleri (mm) Dimension (mm) Размеры (мм)						Kesici Uç Insert Пластина	Yedek Parçaları / Spare Parts / Запасные части		
		D	Z	d	L	l	a		Sıkma Vidası Screw Зажимной винт	Tork Anahtar Torx Key Торк Ключ	
AEM90-AD07-D10-C10-L80-Z02-H	●	10	2	10	80	16	6	ADMX 0702..		3006-M2x3.1	
AEM90-AD07-D12-C12-L90-Z03-H	●	12	3	12	90	18	6				
AEM90-AD07-D16-C16-L110-Z04-H	●	16	4	16	110	19	6				
AEM90-AD07-D20-C20-L125-Z05-H	●	20	5	20	125	20	6				
AEM90-AD07-D25-C25-L140-Z06-H	●	25	6	25	140	24	6				

R: Sağ / Right / Правый L: Sol/Left/Левый
● Stokta / In Stock / В наличии ○ Stokta Yok / Non Stock Item / Нет в наличии
PRMT Ucuna Uygundur. / Compatible with PRMT Insert. / Под пластину PRMT

Sipariş Örneği/Ordering Example/Образец заказа
1 ad./pcs./шт AEM90-AD1505-D25-W25-L150-Z02
Kesme Hesabı : S 321 / Cutting Calculation : P 321 / Расчет режимов резания: стр. 321

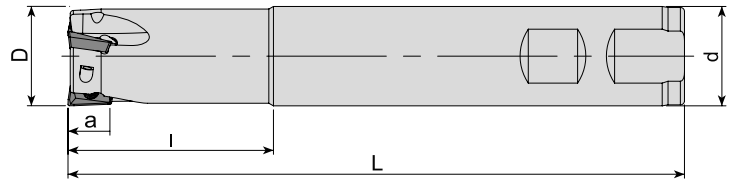

Takım Kodu Ordering Code Код для заказа	Stok Stock Наличие	Takım Ölçüleri (mm) Dimension (mm) Размеры (мм)						Kesici Uç Insert Пластина	Yedek Parçaları / Spare Parts / Запасные части		
		D	Z	d	L	l	a		Sıkma Vidası Screw Зажимной винт	Tork Anahtar Torx Key Торх Ключ	
AEM90-AD0803-D16-W16-L150-Z02	●	16	2	16	150	30	8	ADMT 0803..	3008-M2.5x5		
AEM90-AD0803-D17-W16-L150-Z02	●	17	2	16	150	30	8				
AEM90-AD0803-D17-W16-L200-Z02	●	17	2	16	200	30	8				
AEM90-AD0803-D20-W20-L150-Z03	●	20	3	20	150	30	8				
AEM90-AD0803-D21-W20-L200-Z03	●	21	3	20	200	30	8				
AEM90-AD10T3-D16-W16-L100-Z02-H	●	16	2	16	100	30	10	ADMT 10T3..	3008-M2.5x5	80-T08	
AEM90-AD10T3-D16-W16-L150-Z02	●	16	2	16	150	40	10				
AEM90-AD10T3-D16-C16-L200-Z02	●	16	2	16	200	50	10				
AEM90-AD10T3-D20-W20-L70-Z03	●	20	3	20	70	30	10				
AEM90-AD10T3-D20-W20-L100-Z03-H	●	20	3	20	100	30	10				
AEM90-AD10T3-D20-W20-L150-Z03	●	20	3	20	150	30	10				
AEM90-AD10T3-D20-C20-L150-Z03	●	20	3	20	150	40	10				
AEM90-AD10T3-D20-C20-L200-Z03	●	20	3	20	200	50	10				
AEM90-AD10T3-D25-W25-L100-Z03-H	●	25	3	25	100	30	10				
AEM90-AD10T3-D25-W25-L100-Z04-H	●	25	4	25	100	30	10				
AEM90-AD10T3-D25-W25-L150-Z03	●	25	3	25	150	50	10				
AEM90-AD1204-D20-W20-L150-Z02	●	20	2	20	150	50	12	ADMT 1204..	4010-M3x6	80-T10	
AEM90-AD1204-D21-C20-L150-Z02	●	21	2	20	150	30	10				
AEM90-AD1204-D22-C20-L150-Z02	●	22	2	20	150	30	10				
AEM90-AD1204-D25-W25-L150-Z03	●	25	3	25	150	50	12				
AEM90-AD1204-D32-W32-L150-Z04	●	32	4	32	150	50	12				
AEM90-AD1606-D25-W25-L150-Z02	●	25	2	25	150	50	15	ADMT 1606..	4015-M4x9	80-T15	
AEM90-AD1606-D32-W32-L150-Z03	●	32	3	32	150	50	15				

R: Sağ / Right / Правый L: Sol/Left/Левый
● Stokta / In Stock / В наличии ○ Stokta Yok / Non Stock Item / Нет в наличии
WLTR Ucuna Uygunudur. / Compatiple with WLTR Insert. / Под пластину WLTR

Sipariş Örneği/Ordering Example/Образец заказа
1 ad./pcs./шт AEM90-AD0803-D16-W16-L150-Z02
Kesme Hesabı : S 321 / Cutting Calculation : P 321 / Расчет режимов резания: стр. 321



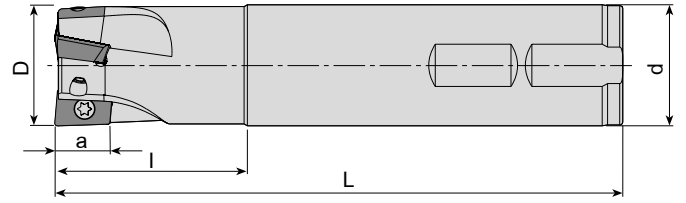

Takım Kodu Ordering Code Код для заказа	Stok Stock Наличие	Takım Ölçüleri (mm) Dimension (mm) Размеры (мм)						Kesici Uç Insert Пластина	Yedek Parçaları / Spare Parts / Запасные части	
		D	Z	d	L	l	a		Sıkma Vidası Screw Зажимной винт	Tork Anahtar Torx Key Торх Ключ
AEM90-AD1003-D16-C16-L150-Z02	●	16	2	16	150	30	8	ADMT 1003..	3008-M2.5x5	80-T08
AEM90-AD1003-D17-C16-L150-Z02	●	17	2	16	150	25	8			
AEM90-AD1003-D20-C20-L200-Z03	●	20	3	20	200	50	8			
AEM90-AD1003-D21-C20-L150-Z03	●	21	3	20	150	25	8			
AEM90-AD1003-D21-C20-L200-Z03	●	21	3	20	200	25	8		3008-M2.5x6	80-T08
AEM90-AD1003-D25-C25-L200-Z03	●	25	3	25	200	50	8			
AEM90-AD1003-D26-C25-L150-Z03	●	26	3	25	150	30	8			
AEM90-AD1003-D26-C25-L200-Z03	●	26	3	25	200	30	8			
AEM90-AD1505D-D25-W25-L150-Z02	●	25	2	25	150	50	14.3	ADKT 150508	4015-M4x9	80-T15
AEM90-AD1505D-D32-W32-L150-Z03	●	32	3	32	150	50	14.3		4015-M4x11	

DJT Ucuna Uygunudur. / Compatible with DJT Insert. / Под пластину DJT

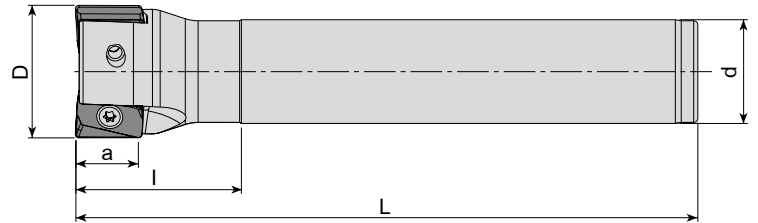

Takım Kodu Ordering Code Код для заказа	Stok Stock Наличие	Takım Ölçüleri (mm) Dimension (mm) Размеры (мм)						Kesici Uç Insert Пластина	Yedek Parçaları / Spare Parts / Запасные части	
		D	Z	d	L	l	a		Sıkma Vidası Screw Зажимной винт	Tork Anahtar Torx Key Торх Ключ
AEM90-AN11-D22-W20-L150-Z02	●	22	2	20	150	30	11	ANGX 110508	4010-M3x8	80-T10
AEM90-AN11-D25-W25-L150-Z02	●	25	2	25	150	40	11			
AEM90-AN11-D25-C25-L200-Z02	●	25	2	25	200	40	11			
AEM90-AN11-D26-W25-L150-Z02	●	26	2	25	150	40	11			
AEM90-AN11-D28-W25-L150-Z02	●	28	2	25	150	25	11			
AEM90-AN11-D32-W32-L150-Z03	●	32	3	32	150	50	11			
AEM90-AN11-D32-C32-L200-Z03	●	32	3	32	200	50	11			
AEM90-AN11-D40-W32-L150-Z04	●	40	4	32	150	40	11			

R: Sağ / Right / Правый L: Sol/Left/Левый

● Stokta / In Stock / В наличии ○ Stokta Yok / Non Stock Item / Нет в наличии
ZCC Ucuna Uygunudur. / Compatible with ZCC Insert. / Под пластину ZCC

Sipariş Örneği/Ordering Example/Образец заказа

1 ad./pcs./шт AEM90-AD1003-D16-C16-L150-Z02

Kesme Hesabı : S 321 / Cutting Calculation : P 321 / Расчет режимов резания: стр. 321



90°

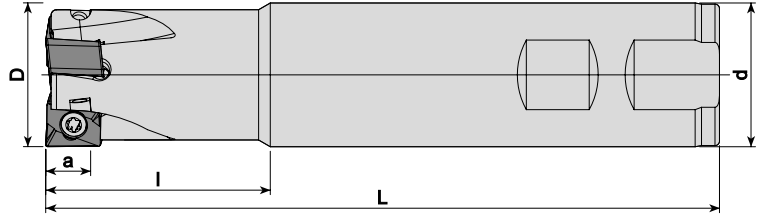

Takım Kodu Ordering Code Код для заказа	Stok Stock Наличие	Takım Ölçüleri (mm) Dimension (mm) Размеры (мм)						Kesici Uç Insert Пластина	Yedek Parçaları / Spare Parts / Запасные части		
		D	Z	d	L	l	a		Sıkma Vidası Screw Зажимной винт	Tork Anahtar Torx Key Торх Ключ	
AEM90-AN1207-D25-W25-L150-Z02	●	25	2	25	150	40	10	ANKX 1207..		4015-M4x11	
AEM90-AN1207-D32-W32-L150-Z03	●	32	3	32	150	50	10				
AEM90-AN1207-D40-W32-L150-Z04	●	40	4	32	150	40	10				

XTC-GSC Ucuna Uygunudur. / Compatible with XTC-GSC Insert. / Под пластину XTC-GSC

90°

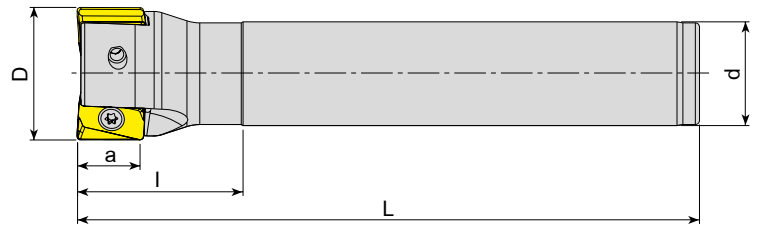

Takım Kodu Ordering Code Код для заказа	Stok Stock Наличие	Takım Ölçüleri (mm) Dimension (mm) Размеры (мм)						Kesici Uç Insert Пластина	Yedek Parçaları / Spare Parts / Запасные части		
		D	Z	d	L	l	a		Sıkma Vidası Screw Зажимной винт	Tork Anahtar Torx Key Торх Ключ	
AEM90-AN1607-D32-C25-L150-Z02	●	32	2	25	150	50	15	AN.X 1607		4015-M4x11	
AEM90-AN1607-D40-C32-L150-Z03	●	40	3	32	150	50	15				

R: Sağ / Right / Правый L: Sol/Left/Левый

● Stokta / In Stock / В наличии ○ Stokta Yok / Non Stock Item / Нет в наличии
TGTC Ucuna Uygunudur. / Compatible with TGTC Insert. / Под пластину TGTC

Sipariş Örneği/Ordering Example/Образец заказа

1 ad./pcs./шт AEM90-AN1207-D25-W25-L150-Z02

Kesme Hesabı : S 321 / Cutting Calculation : P 321 / Расчет режимов резания: стр. 321

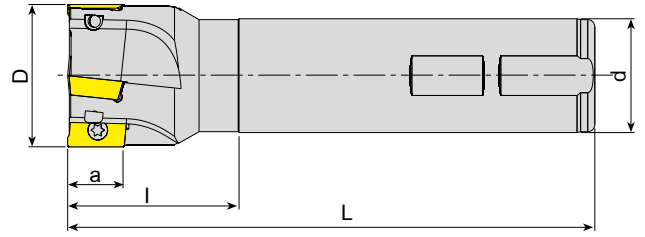

Takım Kodu Ordering Code Код для заказа	Stok Stock Наличие	Takım Ölçüleri (mm) Dimension (mm) Размеры (мм)						Kesici Uç Insert Пластина	Yedek Parçaları / Spare Parts / Запасные части	
		D	Z	d	L	l	a		Sıkma Vidası Screw Зажимной винт	Tork Anahtar Torx Key Торх Ключ
AEM90-AP06-D10-C10-L120-Z02	●	10	2	10	120	20	5.6	APMT 0602.. KRILY UCUNA UYGUNDUR. FOR KRILY INSERT. Под пластину KRILY	3006-M1.8x4	80-T06
AEM90-AP06-D12-C12-L120-Z02	●	12	2	12	120	20	5.6			
AEM90-AP0903-D16-C16-L150-Z02	●	16	2	16	150	30	9	APMT 0903.. KRILY UCUNA UYGUNDUR. FOR KRILY INSERT. Под пластину KRILY	3008-M2.5x5	80-T08
AEM90-AP0903-D17-C16-L150-Z02	●	17	2	16	150	30	9			
AEM90-AP0903-D20-C20-L150-Z02	●	20	2	20	150	30	9	APKT 09T3.. TGTC UCUNA UYGUNDUR. FOR TGTC INSERT. Под пластину TGTC	3008-M2.5x6	80-T08
AEM90-AP0903-D21-C20-L150-Z02	●	21	2	20	150	30	9			
AEM90-AP0903-D25-C25-L150-Z03	●	25	3	25	150	30	9	APKT 09T3.. TGTC UCUNA UYGUNDUR. FOR TGTC INSERT. Под пластину TGTC	3008-M2.5x6	80-T08
AEM90-AP09-D16-C16-L100-Z02-H	●	16	2	16	100	30	8.8			
AEM90-AP09-D16-C15-L150-Z02	●	16	2	15	150	25	8.8	APKT 09T3.. TGTC UCUNA UYGUNDUR. FOR TGTC INSERT. Под пластину TGTC	3008-M2.5x5	80-T08
AEM90-AP09-D16-W16-L150-Z02-H	●	16	2	16	150	25	8.8			
AEM90-AP09-D16-C16-L200-Z02-H	●	16	2	16	200	100	8.8	APKT 09T3.. TGTC UCUNA UYGUNDUR. FOR TGTC INSERT. Под пластину TGTC	3008-M2.5x6	80-T08
AEM90-AP09-D17-C16-L150-Z02	●	17	2	16	150	25	8.8			
AEM90-AP09-D17-C16-L180-Z02-H	●	17	2	16	180	25	8.8	APKT 09T3.. TGTC UCUNA UYGUNDUR. FOR TGTC INSERT. Под пластину TGTC	3008-M2.5x6	80-T08
AEM90-AP09-D20-C20-L150-Z03-H	●	20	3	20	150	50	8.8			
AEM90-AP09-D20-C20-L200-Z03-H	●	20	3	20	200	100	8.8	APKT 09T3.. TGTC UCUNA UYGUNDUR. FOR TGTC INSERT. Под пластину TGTC	3008-M2.5x6	80-T08
AEM90-AP09-D20-C20-L250-Z02-H	●	20	2	20	250	150	8.8			
AEM90-AP09-D21-C20-L150-Z03	●	21	3	20	150	25	8.8	APKT 09T3.. TGTC UCUNA UYGUNDUR. FOR TGTC INSERT. Под пластину TGTC	3008-M2.5x6	80-T08
AEM90-AP09-D26-C25-L150-Z04	●	26	4	25	150	30	8.8			
AEM90-AP10-D12-W16-L100-Z01-H	●	12	1	16	100	30	10	AP.. 1003.. ISO UCUNA UYGUNDUR. FOR ISO INSERT. Под пластину ISO	3008-M2.5x5	80-T08
AEM90-AP10-D12-W16-L150-Z01	●	12	1	16	150	38	10			
AEM90-AP10-D14-W16-L100-Z01-H	●	14	1	16	100	30	10			



R: Sağ / Right / Правый L: Sol/Left/Левый
● Stokta / In Stock / В наличии ○ Stokta Yok / Non Stock Item / Нет в наличии

Sipariş Örneği/Ordering Example/Образец заказа
1 ad./pcs./шт AEM90-AP06-D10-C10-L120-Z02
Kesme Hesabı : S 321 / Cutting Calculation : P 321 / Расчет режимов резания: стр. 321

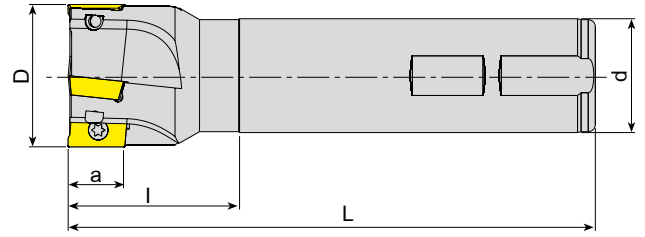
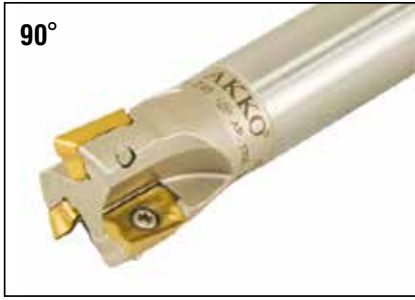

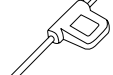

Takım Kodu
Ordering Code
Код для заказа

Stok Stock Наличие	Takım Ölçüleri (mm) Dimension (mm) Размеры (мм)							Kesici Uç Insert Пластина	Yedek Parçaları / Spare Parts / Запасные части		
	D	Z	d	L	l	a	Sıkma Vidası Screw Зажимной винт		Tork Anahtar Torx Key Торх Ключ		
●	14	1	16	150	38	10			3008-M2.5x5		
●	16	2	16	100	30	10					
●	16	2	16	100	30	10					
●	16	2	16	120	30	10					
●	16	2	16	150	50	10					
●	16	2	16	150	50	10					
●	16	2	16	150	50	10					
●	16	2	16	200	100	10					
●	16	2	16	200	100	10					
●	16	2	16	250	50	10					
●	18	2	16	100	30	10					
●	18	2	16	150	30	10					
●	20	3	20	100	30	10					
●	20	3	20	100	30	10					
●	20	3	20	120	30	10					
●	20	3	20	150	50	10					
●	20	3	20	150	50	10					
●	20	3	20	150	50	10					
●	20	3	20	200	100	10					
●	20	2	20	200	100	10					
●	20	2	20	250	150	10					
●	20	2	20	250	150	10					
●	20	2	20	250	150	10					
●	21	3	20	150	30	10					
●	22	3	20	100	30	10					
●	22	3	20	150	30	10					
●	23	3	20	150	30	10					
●	24	3	20	150	30	10					
●	25	4	25	100	30	10					
●	25	3	25	100	30	10					
●	25	3	25	100	30	10					
●	25	3	25	120	30	10					
●	25	3	25	150	50	10					
●	25	3	25	150	50	10					
●	25	2	25	200	100	10					
●	25	3	25	200	100	10					
●	25	2	25	250	100	10					

AP.. 1003..
ISO UCUNA
UYGUNDUR.
FOR ISO INSERT.
Под пластину ISO

3008-M2.5x6

80-T08

R: Sağ / Right / Правый L: Sol/Left/ Левый

● Stokta / In Stock / В наличии ○ Stokta Yok / Non Stock Item / Нет в наличии

Sipariş Örneği/Ordering Example/Образец заказа

1 ad./pcs./шт AEM90-AP10-D14-W16-L150-Z01

Kesme Hesabı : S 321 / Cutting Calculation : P 321 / Расчет режимов резания: стр. 321

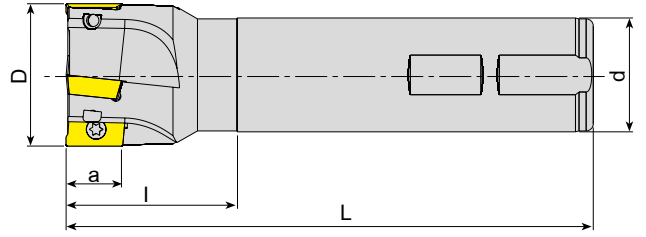
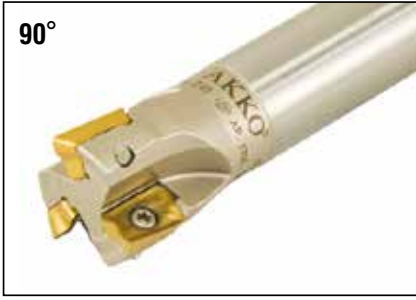

Takım Kodu Ordering Code Код для заказа	Stok Stock Наличие	Takım Ölçüleri (mm) Dimension (mm) Размеры (мм)						Kesici Uç Insert Пластина	Yedek Parçaları / Spare Parts / Запасные части		
		D	Z	d	L	l	a		Sıkma Vidası Screw Зажимной винт	Tork Anahtar Torx Key Торкс Ключ	
AEM90-AP10-D30-C25-L100-Z04-H	●	30	4	25	100	30	10	AP.. 1003.. ISO UCUNA UYGUNDUR. FOR ISO INSERT. Под пластину ISO	3008-M2.5x6		
AEM90-AP10-D30-C25-L120-Z04-H	●	30	4	25	120	30	10				
AEM90-AP10-D30-C25-L150-Z04	●	30	4	25	150	30	10				
AEM90-AP10-D32-C25-L100-Z04-H	●	32	4	25	100	35	10				
AEM90-AP10-D32-C25-L120-Z04-H	●	32	4	25	120	35	10				
AEM90-AP10-D32-C25-L150-Z04	●	32	4	25	150	35	10				
AEM90-AP10-D32-W25-L150-Z04	●	32	4	25	150	35	10				
AEM90-AP10-D32-C32-L130-Z05	●	32	5	32	130	30	10				
AEM90-AP10-D32-W32-L150-Z04	●	32	4	32	150	50	10				
AEM90-AP10-D40-W32-L150-Z05	●	40	5	32	150	40	10				
AEM90-AP10D-D16-W16-L150-Z02	●	16	2	16	150	50	10	AP.. 1003.. DJT UCUNA UYGUNDUR. FOR DJT INSERT. Под пластину DJT	3008-M2.5x5	80-T08	
AEM90-AP10D-D20-W20-L150-Z03	●	20	3	20	150	50	10				
AEM90-AP100-D16-C15-L150-Z02	●	16	2	15	150	30	10				
AEM90-AP100-D21-C20-L150-Z03	●	21	3	20	150	30	10				
AEM90-AP100-D26-C25-L150-Z04	●	26	4	25	150	35	10				
AEM90-AP100-D33-C32-L200-Z05	○	33	5	32	200	50	10				
AEM90-AP10S-D16-W16-L150-Z02	○	16	2	16	150	26	10				
AEM90-AP10S-D20-W20-L150-Z02	●	20	2	20	150	26	10				
AEM90-AP10S-D25-W25-L150-Z03	●	25	3	25	150	26	10				
AEM90-AP10S-D25-W25-L150-Z03-H	●	25	3	25	150	26	10				
AEM90-AP11-D16-C16-L150-Z02	●	16	2	16	150	50	11	AP.. 11T3.. ZCC UCUNA UYGUNDUR. FOR ZCC INSERT. Под пластину ZCC	3008-M2.5x6	80-T08	
AEM90-AP11-D16-C16-L150-Z02-H	●	16	2	16	150	50	11				
AEM90-AP11-D16-W16-L150-Z02	●	16	2	16	150	50	11				
AEM90-AP11-D16-W16-L150-Z02-H	●	16	2	16	150	50	11				
AEM90-AP11-D16-C16-L200-Z02	●	16	2	16	200	100	11				
AEM90-AP11-D17-C16-L150-Z02	●	17	2	16	150	30	11				
AEM90-AP11-D17-C16-L200-Z02	●	17	2	16	200	30	11				
AEM90-AP11-D20-C20-L150-Z03	●	20	3	20	150	50	11				
AEM90-AP11-D20-W20-L150-Z03	●	20	3	20	150	50	11				
AEM90-AP11-D20-W20-L150-Z03-H	●	20	3	20	150	50	11				
AEM90-AP11-D20-C20-L200-Z03	●	20	3	20	200	100	11				
AEM90-AP11-D21-C20-L150-Z03	●	21	3	20	150	30	11				
AEM90-AP11-D21-W20-L150-Z03	●	21	3	20	150	30	11				
AEM90-AP11-D21-W20-L150-Z03-H	●	21	3	20	150	30	11				
AEM90-AP11-D21-C20-L200-Z03	●	21	3	20	200	30	11				
AEM90-AP11-D25-C25-L150-Z03	●	25	3	25	150	50	11				
AEM90-AP11-D25-W25-L150-Z03	●	25	3	25	150	50	11				
AEM90-AP11-D25-W25-L150-Z03-H	●	25	3	25	150	50	11				
AEM90-AP11-D26-C25-L150-Z03	●	26	3	25	150	35	11				
AEM90-AP11-D26-C24-L150-Z03	●	26	3	24	150	47	11				
AEM90-AP11-D32-W25-L150-Z04	●	32	4	25	150	35	11				
AEM90-AP11-D32-W32-L150-Z03-H	●	32	3	32	150	50	11				
AEM90-AP11-D32-W32-L150-Z04	●	32	4	32	150	50	11				

R: Sağ / Right / Правый L: Sol/Left/Левый

● Stokta / In Stock / В наличии ○ Stokta Yok / Non Stock Item / Нет в наличии



www.akkо.com.tr

Sipariş Örneği/Ordering Example/Образец заказа

1 ad./pcs./шт AEM90-AP10-D30-C25-L100-Z04-H

Kesme Hesabı : S 321 / Cutting Calculation : P 321 / Расчет режимов резания: стр. 321

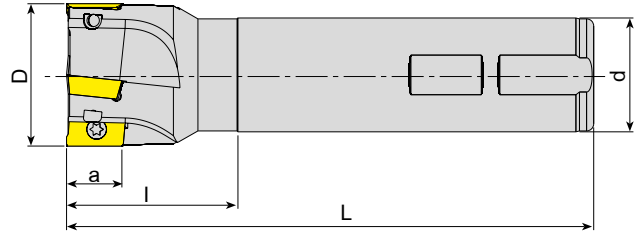



Takım Kodu Ordering Code Код для заказа	Stok Stock Наличие	Takım Ölçüleri (mm) Dimension (mm) Размеры (мм)						Kesici Uç Insert Пластина	Yedek Parçaları / Spare Parts / Запасные части				
		D	Z	d	L	l	a		Sikma Vidası Screw Зажимной винт	Tork Anahtar Torx Key Торх Ключ			
AEM90-AP1135A-D14-C16-L150-Z01	●	14	1	16	150	40	9.5	APMT 1135.. ACHTK UCUNA UYGUNDUR. FOR ACHTK INSERT. Под пластину ACHTK	3008-M2.5x5	80-T08			
AEM90-AP1135A-D16-C16-L150-Z02	●	16	2	16	150	40	9.5						
AEM90-AP1135A-D16-C16-L200-Z02	●	16	2	16	200	100	9.5						
AEM90-AP1135A-D16-C16-L250-Z02	●	16	2	16	250	150	9.5						
AEM90-AP1135A-D17-C16-L180-Z02	●	17	2	16	180	30	9.5						
AEM90-AP1135A-D20-C20-L150-Z03	●	20	3	20	150	50	9.5						
AEM90-AP1135A-D20-C20-L200-Z02	●	20	2	20	200	100	9.5						
AEM90-AP1135A-D21-C20-L180-Z02	●	21	2	20	180	30	9.5						
AEM90-AP1135A-D25-C25-L200-Z03	●	25	3	25	200	100	9.5						
AEM90-AP1135A-D26-C25-L250-Z02	●	26	2	25	250	35	9.5						
AEM90-AP1135A-D33-C32-L250-Z02	●	33	2	32	250	35	9.5	AP.. 1135.. B.OKE UCUNA UYGUNDUR. FOR B.OKE INSERT Под пластину B.OKE	3008-M2.5x5	80-T08			
AEM90-AP110-D16-C15-L150-Z02	●	16	2	15	150	30	11						
AEM90-AP110-D21-C20-L150-Z03	●	21	3	20	150	30	11						
AEM90-AP110-D26-C25-L150-Z04	●	26	4	25	150	35	11						
AEM90-AP110-D33-C32-L200-Z05	●	33	5	32	200	50	11						
AEM90-APK11G-D16-W16-L150-Z02	●	16	2	16	150	26	11						
AEM90-APK11G-D20-W20-L150-Z03	●	20	3	20	150	26	11						
AEM90-APK11G-D25-W25-L150-Z03	●	25	3	25	150	26	11						
AEM90-AP1135-D16-W16-L110-Z02-H	●	16	2	16	110	30	9.5						
AEM90-AP1135-D16-W16-L150-Z02	●	16	2	16	150	50	9.5						
AEM90-AP1135-D20-W20-L125-Z03-H	●	20	3	20	125	30	9.5	AP.. 1135.. XTC-GSC UCUNA UYGUNDUR. FOR XTC-GSC INSERT. Под пластину XTC-GSC	3008-M2.5x6	80-T10			
AEM90-AP1135-D20-W20-L150-Z03	●	20	3	20	150	50	9.5						
AEM90-AP1135-D25-W25-L125-Z04-H	●	25	4	25	125	30	9.5						
AEM90-AP1135-D25-W25-L200-Z04-H	●	25	4	25	200	100	9.5						
AEM90-AP1135-D32-W32-L125-Z05-H	●	32	5	32	125	30	9.5						
AEM90-AP1135-D32-W32-L200-Z04-H	●	32	4	32	200	100	9.5						
AEM90-AP1204-D20-C20-L150-Z02	●	20	2	20	150	30	12				AP.. 1204.. TGTC UCUNA UYGUNDUR. FOR TGTC INSERT. Под пластину TGTC	3010-M3.5x7	80-T10
AEM90-AP1204-D21-C20-L150-Z02	●	21	2	20	150	30	12						
AEM90-AP1204-D21-C20-L200-Z02	●	21	2	20	200	30	12						
AEM90-AP1204-D25-C25-L150-Z03	●	25	3	25	150	40	12						
AEM90-AP1204-D26-C25-L250-Z02	●	26	2	25	250	35	12						
AEM90-AP1204-D32-C25-L150-Z03	●	32	3	25	150	35	12						
AEM90-AP16-D25-C20-L100-Z02	●	25	2	20	100	35	16	AP.. 1604.. ISO UCUNA UYGUNDUR. FOR ISO INSERT. Под пластину ISO	4015-M4x9	80-T15			
AEM90-AP16-D25-W25-L100-Z02-H	●	25	2	25	100	35	16						
AEM90-AP16-D25-W25-L150-Z02	●	25	2	25	150	50	16						
AEM90-AP16-D25-C25-L250-Z02	●	25	2	25	250	100	16						
AEM90-AP16-D28-W25-L100-Z03-H	●	28	3	25	100	40	16						
AEM90-AP16-D28-W25-L150-Z03	●	28	3	25	150	40	16						
AEM90-AP16-D30-W25-L110-Z03-H	●	30	3	25	110	40	16						
AEM90-AP16-D30-W25-L150-Z02	●	30	2	25	150	40	16						

R: Sağ / Right / Правый L: Sol/Left/Левый
● Stokta / In Stock / В наличии ○ Stokta Yok / Non Stock Item / Нет в наличии

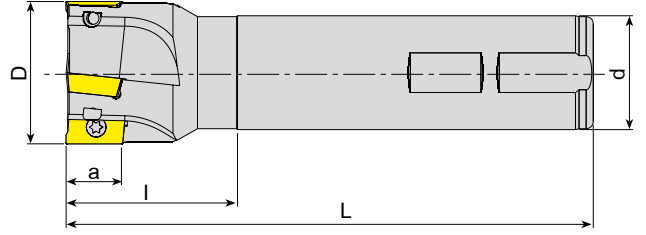
Sipariş Örneği/Ordering Example/Образец заказа
1 ad./pcs./шт AEM90-AP1135A-D14-C16-L150-Z01
Kesme Hesabı : S 321 / Cutting Calculation : P 321 / Расчет режимов резания: стр. 321

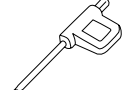

Takım Kodu Ordering Code Код для заказа	Stok Stock Наличие	Takım Ölçüleri (mm) Dimension (mm) Размеры (мм)						Kesici Uç Insert Пластина	Yedek Parçaları / Spare Parts / Запасные части	
		D	Z	d	L	l	a		Sıkma Vidası Screw Зажимной винт	Tork Anahtar Torx Key Торх Ключ
AEM90-AP16-D30-W25-L150-Z03	●	30	3	25	150	40	16	 AP.. 1604.. ISO UCUNA UYGUNDUR. FOR ISO INSERT Под пластину ISO	 4015-M4x9	 80-T15
AEM90-AP16-D32-W32-L110-Z03-H	●	32	3	32	110	40	16			
AEM90-AP16-D32-C32-L150-Z03	●	32	3	32	150	50	16			
AEM90-AP16-D32-W25-L150-Z03	●	32	3	25	150	40	16			
AEM90-AP16-D32-W32-L150-Z03	●	32	3	32	150	50	16			
AEM90-AP16-D32-W32-L150-Z03-H	●	32	3	32	150	50	16			
AEM90-AP16-D32-C25-L200-Z03-H	●	32	3	25	200	40	16			
AEM90-AP16-D32-C32-L250-Z02	●	32	2	32	250	100	16			
AEM90-AP16-D32-C32-L250-Z03	●	32	3	32	250	100	16			
AEM90-AP16-D35-W32-L150-Z03	●	35	3	32	150	40	16			
AEM90-AP16-D36-W32-L110-Z03-H	●	36	3	32	110	40	16			
AEM90-AP16-D36-W32-L150-Z03	●	36	3	32	150	40	16			
AEM90-AP16-D40-W32-L110-Z04-H	●	40	4	32	110	40	16			
AEM90-AP16-D40-C32-L150-Z04	●	40	4	32	150	40	16			
AEM90-AP16-D40-W32-L150-Z04	●	40	4	32	150	40	16			
AEM90-AP16-D40-C32-L250-Z02	●	40	2	32	250	40	16			
AEM90-AP16-D40-C32-L250-Z04	●	40	4	32	250	40	16			
AEM90-AP16DJ-D25-W25-L150-Z02	●	25	2	25	150	50	16	AP.. 1604.. DJT UCUNA UYGUNDUR. FOR DJT INSERT. Под пластину DJT	4015-M4x9	80-T15
AEM90-AP16DJ-D25-C25-L200-Z02	●	25	2	25	200	50	16			
AEM90-AP16DJ-D32-W32-L150-Z03	●	32	3	32	150	50	16			
AEM90-AP16DJ-D32-C32-L180-Z03	●	32	3	32	180	50	16			
AEM90-AP16DJ-D32-C32-L200-Z03	●	32	3	32	200	50	16	AP.. 1604.. LMN UCUNA UYGUNDUR. FOR LMN INSERT. Под пластину LMN	4015-M4x9	80-T15
AEM90-AP16L-D25-C25-L120-Z02-H	●	25	2	25	120	45	16			
AEM90-AP16L-D25-C25-L150-Z02	●	25	2	25	150	55	16			
AEM90-AP16L-D25-C25-L200-Z02	●	25	2	25	200	55	16			
AEM90-AP16L-D25-C25-L250-Z02	●	25	2	25	250	100	16			
AEM90-AP16L-D32-C32-L120-Z03-H	●	32	3	32	120	45	16			
AEM90-AP16L-D32-C32-L150-Z03	●	32	3	32	150	55	16			
AEM90-AP16L-D32-C32-L200-Z03	●	32	3	32	200	55	16			
AEM90-AP16L-D32-C32-L250-Z03	●	32	3	32	250	100	16			
AEM90-AP16L-D40-C32-L120-Z04-H	●	40	4	32	120	40	16			
AEM90-AP16L-D40-C32-L150-Z04	●	40	4	32	150	40	16			
AEM90-AP16L-D40-C32-L200-Z04	●	40	4	32	200	40	16			
AEM90-AP16L-D40-C32-L250-Z04	●	40	4	32	250	40	16			

R: Sağ / Right / Правый L: Sol/Left/Левый

● Stokta / In Stock / В наличии ○ Stokta Yok / Non Stock Item / Нет в наличии

Sipariş Örneği/Ordering Example/Образец заказа

1 ad./pcs./шт AEM90-AP16-D30-W25-L150-Z03

Kesme Hesabı : S 321 / Cutting Calculation : P 321 / Расчет режимов резания: стр. 321

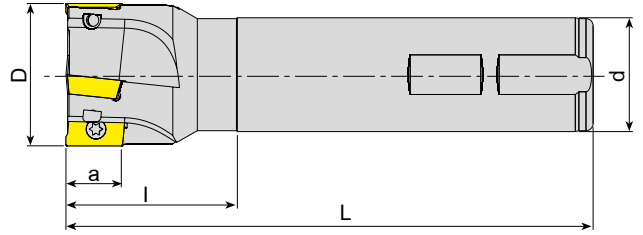
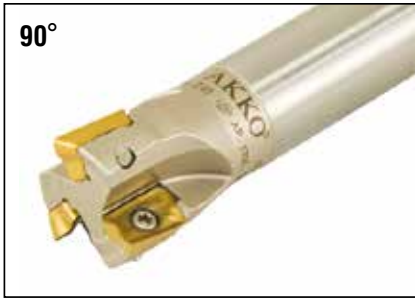

Takım Kodu Ordering Code Код для заказа	Stok Stock Наличие	Takım Ölçüleri (mm) Dimension (mm) Размеры (мм)						Kesici Uç Insert Пластина	Yedek Parçaları / Spare Parts / Запасные части		
		D	Z	d	L	l	a		Sıkma Vidası Screw Зажимной винт	Tork Anahtar Torx Key Торх Ключ	
AEM90-AP16P-D25-W25-L100-Z02-H	●	25	2	25	100	35	16	AP.. 1604.. PLBT UCUNA UYGUNDUR. FOR PLBT INSERT. Под пластину PLBT	4015-M4x9	80-T15	
AEM90-AP16P-D25-W25-L150-Z02	●	25	2	25	150	50	16				
AEM90-AP16P-D32-W32-L150-Z03	●	32	3	32	150	50	16				
AEM90-AP16P-D32-C32-L250-Z02	●	32	2	32	250	100	16				
AEM90-AP16P-D40-W32-L150-Z04	●	40	4	32	150	50	16	AP.. 1705.. TGTC-LMN UCUNA UYGUNDUR. FOR TGTC-LMN INSERT. Под пластину TGTC-LMN	80-T15		
AEM90-AP1705-D25-C25-L120-Z02	●	25	2	25	120	40	16				
AEM90-AP1705-D26-C25-L200-Z02	●	26	2	25	200	40	16				
AEM90-AP1705-D26-C25-L250-Z02	●	26	2	25	250	40	16				
AEM90-AP1705-D26-C25-L300-Z02	○	26	2	25	300	40	16				
AEM90-AP1705-D28-W25-L075-Z02	●	28	2	25	75	20	16				
AEM90-AP1705-D32-C25-L150-Z03	●	32	3	25	150	40	16				
AEM90-AP1705-D33-C32-L250-Z03	●	33	3	32	250	40	16				
AEM90-AP1705-D33-C32-L300-Z02	●	33	2	32	300	40	16				

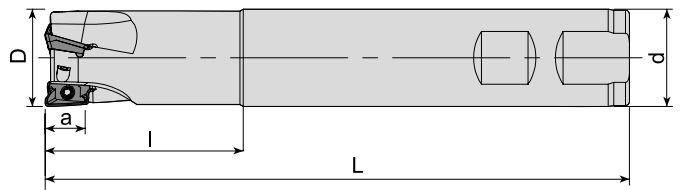

Takım Kodu Ordering Code Код для заказа	Stok Stock Наличие	Takım Ölçüleri (mm) Dimension (mm) Размеры (мм)						Kesici Uç Insert Пластина	Yedek Parçaları / Spare Parts / Запасные части		
		D	Z	d	L	l	a		Sıkma Vidası Screw Зажимной винт	Tork Anahtar Torx Key Торх Ключ	
AEM90-AO1236-D16-W16-L150-Z02	●	16	2	16	150	50	12	AO..1236..	3008-M2.5x6	80-T08	
AEM90-AO1236-D20-C20-L100-Z02	○	20	2	20	100	30	12				
AEM90-AO1236-D25-C25-L115-Z02	○	25	2	25	150	50	12				
AEM90-AO1236-D25-W25-L150-Z03	●	25	3	25	150	50	12				
AEM90-AO1236-D32-W32-L150-Z04	●	32	4	32	150	50	12				

R: Sağ / Right / Правый L: Sol/Left/Левый
● Stokta / In Stock / В наличии ○ Stokta Yok / Non Stock Item / Нет в наличии
MTSBH Ucuna Uygunur. / Compatiple with MTSBH Insert. / Под пластину MTSBH

Sipariş Örneği/Ordering Example/Образец заказа
1 ad./pcs./шт AEM90-AP16-D30-W25-L150-Z03
Kesme Hesabı : S 321 / Cutting Calculation : P 321 / Расчет режимов резания: стр. 321

90°

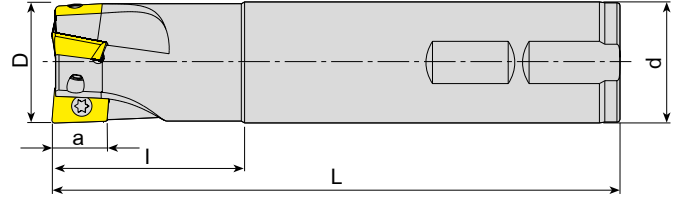

Takım Kodu Ordering Code Код для заказа	Stok Stock Наличие	Takım Ölçüleri (mm) Dimension (mm) Размеры (мм)						Kesici Uç Insert Пластина	Yedek Parçaları / Spare Parts / Запасные части	
		D	Z	d	L	l	a		Sıkma Vidası Screw Зажимной винт	Tork Anahtar Torx Key Торх Ключ
AEM90-AX0602-D10-C09-L120-Z02	●	10	2	9	120	20	5.7	AX.. 0602	3006-M1.8x4	80-T06
AEM90-AX0602-D10-C10-L080-Z02	●	10	2	10	80	20	5.7			
AEM90-AX0602-D10-C10-L120-Z02	●	10	2	10	120	20	5.7			
AEM90-AX0602-D12-C11-L120-Z02	●	12	2	11	120	20	5.7			
AEM90-AX0602-D12-C12-L080-Z02	●	12	2	12	80	20	5.7			
AEM90-AX0602-D12-C12-L120-Z02	●	12	2	12	120	20	5.7			
AEM90-AX0602-D14-C12-L120-Z03	●	14	3	12	120	20	5.7			
AEM90-AX0602-D16-W16-L120-Z04-H	●	16	4	16	120	20	5.7			
AEM90-AX0602-D16-W16-L150-Z04-H	●	16	4	16	150	20	5.7			
AEM90-AX0602-D20-W20-L120-Z05-H	●	20	5	20	120	25	5.7			
AEM90-AX0602-D20-W20-L150-Z05-H	●	20	5	20	150	25	5.7			
AEM90-AX0903-D16-C16-L120-Z02	●	16	2	16	120	30	8.8	AX.. 0903	3008-M2.5x5	80-T08
AEM90-AX0903-D16-C16-L180-Z02	●	16	2	16	180	30	8.8			
AEM90-AX0903-D17-C16-L120-Z02	●	17	2	16	120	25	8.8			
AEM90-AX0903-D17-C16-L180-Z02	●	17	2	16	180	25	8.8			
AEM90-AX0903-D20-C20-L120-Z03	●	20	3	20	120	30	8.8			
AEM90-AX0903-D20-C20-L200-Z02	●	20	2	20	200	30	8.8			
AEM90-AX0903-D21-C20-L120-Z03	●	21	3	20	120	25	8.8			
AEM90-AX0903-D21-C20-L200-Z02	●	21	2	20	200	25	8.8			
AEM90-AX0903-D25-C25-L150-Z03	●	25	3	25	150	30	8.8			
AEM90-AX0903-D25-C25-L250-Z02	●	25	2	25	250	40	8.8			
AEM90-AX0903-D26-C25-L150-Z03	●	26	3	25	150	30	8.8			

R: Sağ / Right / Правый L: Sol/Left/Левый
● Stokta / In Stock / В наличии ○ Stokta Yok / Non Stock Item / Нет в наличии
TGTC Uçuna Uygundur. / Compatible with TGTC Insert. / Под пластину TGTC

Sipariş Örneği/Ordering Example/Образец заказа
1 ad./pcs./шт AX0602-D10-C09-L120-Z02
Kesme Hesabı : S 321 / Cutting Calculation : P 321 / Расчет режимов резания: стр. 321



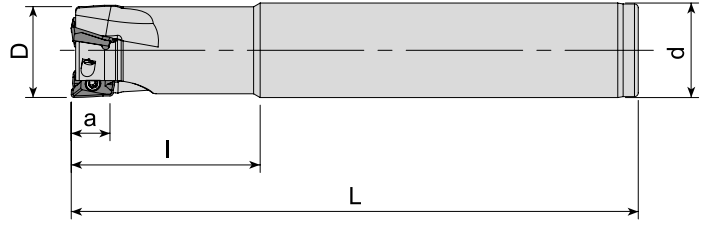

Takım Kodu Ordering Code Код для заказа	Stok Stock Наличие	Takım Ölçüleri (mm) Dimension (mm) Размеры (мм)						Kesici Uç Insert Пластина	Yedek Parçaları / Spare Parts / Залпасные части		
		D	Z	d	L	l	a		Sıkma Vidası Screw Зажимной винт	Tork Anahtar Torx Key Торх Ключ	
AEM90-AX1235-D16-C14-L120-Z02-H	●	16	2	14	120	25	10	AX.T 1235..			
AEM90-AX1235-D16-C15-L145-Z02-H	●	16	2	15	145	30	10				
AEM90-AX1235-D16-C16-L100-Z02-H	●	16	2	16	100	30	10				
AEM90-AX1235-D16-C16-L140-Z02-H	●	16	2	16	140	30	10				
AEM90-AX1235-D16-C16-L145-Z02-H	●	16	2	16	145	30	10				
AEM90-AX1235-D16-C16-L150-Z02	●	16	2	16	150	30	10				
AEM90-AX1235-D20-C19-L150-Z02-H	●	20	2	19	150	40	10				
AEM90-AX1235-D20-C20-L110-Z03-H	●	20	3	20	110	40	10				
AEM90-AX1235-D20-C20-L150-Z02	●	20	2	20	150	40	10				
AEM90-AX1235-D20-C20-L150-Z02-H	●	20	2	20	150	40	10				
AEM90-AX1235-D20-C20-L150-Z03	●	20	3	20	150	40	10				
AEM90-AX1235-D25-C20-L120-Z04-H	●	25	4	20	120	30	10				
AEM90-AX1235-D25-C20-L150-Z04-H	●	25	4	20	150	30	10				
AEM90-AX1235-D25-C24-L170-Z02-H	●	25	2	24	170	50	10				
AEM90-AX1235-D25-C25-L120-Z04-H	●	25	4	25	120	40	10				
AEM90-AX1235-D25-C25-L150-Z03	●	25	3	25	150	50	10				
AEM90-AX1235-D25-C25-L170-Z02-H	●	25	2	25	170	50	10				
AEM90-AX1235-D25-W25-L100-Z04-H	●	25	4	25	100	30	10				
AEM90-AX1235-D32-C32-L130-Z05-H	●	32	5	32	130	40	10				
AEM90-AX1235-D32-C32-L180-Z02-H	●	32	2	32	180	50	10				
AEM90-AX1705-D25-C25-L150-Z02	●	25	2	25	150	50	14	AX.T 1705..	4015-M4x9	80-T15	
AEM90-AX1705-D28-W25-L115-Z02-H	●	28	2	25	115	35	14				
AEM90-AX1705-D32-C32-L150-Z03	●	32	3	32	150	50	14				
AEM90-AX1705-D32-C32-L180-Z02-H	●	32	2	32	180	50	14				

R: Sağ / Right / Правый L: Sol/Left/Левый
● Stokta / In Stock / В наличии ○ Stokta Yok / Non Stock Item / Нет в наличии
SMTM Ucuna Uygunudur. / Compatible with SMTM Insert. / Под пластину SMTM

Sipariş Örneği/Ordering Example/Образец заказа
1 ad./pcs./шт AX0235-D16-C14-L120-Z02-H
Kesme Hesabı : S 321 / Cutting Calculation : P 321 / Расчет режимов резания: стр. 321

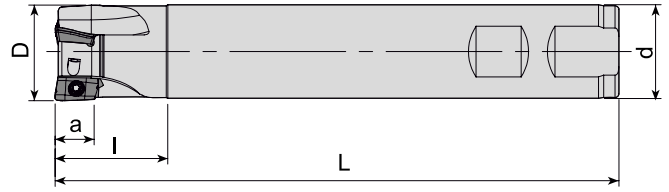



Takım Kodu Ordering Code Код для заказа	Stok Stock Наличие	Takım Ölçüleri (mm) Dimension (mm) Размеры (мм)						Kesici Uç Insert Пластина	Yedek Parçaları / Spare Parts / Запасные части		
		D	Z	d	L	l	a		Sıkma Vidası Screw Зажимной винт	Tork Anahtar Torx Key Торх Ключ	
AEM90-AZ11-D12-W16-L90-Z01	●	12	1	16	90	30	11	AZGT 1135..	3008-M2.5X5		
AEM90-AZ11-D16-C16-L200-Z02	●	16	2	16	200	100	11				
AEM90-AZ11-D16-W15-L170-Z02	●	16	2	15	170	50	11				
AEM90-AZ11-D16-W16-L100-Z02	●	16	2	16	100	35	11				
AEM90-AZ11-D16-W16-L150-Z02	●	16	2	16	150	50	11				
AEM90-AZ11-D17-C16-L150-Z02	●	17	2	16	150	30	11				
AEM90-AZ11-D17-C16-L180-Z02	●	17	2	16	180	50	11				
AEM90-AZ11-D17-W16-L100-Z02	●	17	2	16	100	30	11				
AEM90-AZ11-D20-C20-L200-Z03	●	20	3	20	200	100	11				
AEM90-AZ11-D20-W19-L170-Z03	●	20	3	19	170	50	11		3008-M2.5X6	80-T08	
AEM90-AZ11-D20-W20-L110-Z02	●	20	2	20	110	35	11				
AEM90-AZ11-D21-C20-L150-Z03	●	21	3	20	150	30	11				
AEM90-AZ11-D21-C20-L180-Z03	●	21	3	20	180	50	11				
AEM90-AZ11-D21-W20-L110-Z03	●	21	3	20	110	35	11				
AEM90-AZ11-D25-C24-L180-Z04	●	25	4	24	180	50	11				
AEM90-AZ11-D25-W25-L110-Z04	●	25	4	25	110	40	11				
AEM90-AZ11-D26-C25-L250-Z02	●	26	2	25	250	50	11				
AEM90-AZ11-D26-W25-L120-Z03	●	26	3	25	120	30	11				
AEM90-AZ11-D26-W25-L120-Z04	●	26	4	25	120	40	11				
AEM90-AZ11-D28-C25-L250-Z02	●	28	2	25	250	50	11				
AEM90-AZ11-D33-W32-L130-Z04	●	33	4	32	130	50	11				

R: Sağ / Right / Правый L: Sol/Left/Левый
● Stokta / In Stock / В наличии ○ Stokta Yok / Non Stock Item / Нет в наличии
ZCC Uyumlu Uygundur. / Compatible with ZCC Insert. / Под пластину ZCC

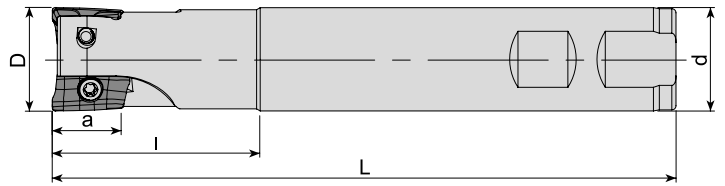
Sipariş Örneği/Ordering Example/Образец заказа
1 ad./pcs./шт AEM90-AZ11-D12-W16-L90-Z01
Kesme Hesabı : S 321 / Cutting Calculation : P 321 / Расчет режимов резания: стр. 321



Takım Kodu Ordering Code Код для заказа	Stok Stock Наличие	Takım Ölçüleri (mm) Dimension (mm) Размеры (мм)						Kesici Uç Insert Пластина	Yedek Parçaları / Spare Parts / Залпасные части				
		D	Z	d	L	l	a		Sıkma Vidası Screw Зажимной винт	Tork Anahtar Torx Key Торх Ключ			
AEM90-BD11T3-D16-C15-L180-Z02	●	16	2	15	180	50	10		3008-M2.5x5				
AEM90-BD11T3-D16-C16-L100-Z02-H	●	16	2	16	100	30	10						
AEM90-BD11T3-D16-W16-L100-Z02-H	●	16	2	16	100	30	10						
AEM90-BD11T3-D16-W16-L150-Z02	●	16	2	16	150	50	10						
AEM90-BD11T3-D17-W16-L150-Z02	●	17	2	16	150	25	10						
AEM90-BD11T3-D17-C16-L180-Z02	●	17	2	16	180	50	10						
AEM90-BD11T3-D18-W16-L100-Z02	●	18	2	16	100	25	10						
AEM90-BD11T3-D18-W16-L100-Z02-H	●	18	2	16	100	25	10						
AEM90-BD11T3-D20-W20-L100-Z02-H	●	20	2	20	100	30	10						
AEM90-BD11T3-D20-W20-L100-Z03-H	●	20	3	20	100	30	10						
AEM90-BD11T3-D20-C20-L110-Z03-H	●	20	3	30	110	30	10						
AEM90-BD11T3-D20-W20-L150-Z02	●	20	2	20	150	50	10						
AEM90-BD11T3-D20-W20-L150-Z03	●	20	3	20	150	50	10						
AEM90-BD11T3-D21-W20-L150-Z03	●	21	3	20	150	25	10						
AEM90-BD11T3-D21-C20-L200-Z02	●	21	2	20	200	25	10						
AEM90-BD11T3-D22-W20-L090-Z02-H	●	22	2	20	90	25	10		BDMT 11T3..	3008-M2.5x6	80-T08		
AEM90-BD11T3-D25-W25-L100-Z03-H	●	25	3	25	100	30	10						
AEM90-BD11T3-D25-C25-L120-Z03-H	●	25	3	25	120	30	10						
AEM90-BD11T3-D25-W25-L150-Z03	●	25	3	25	150	50	10						
AEM90-BD11T3-D26-W25-L150-Z03	●	26	3	25	150	35	10						
AEM90-BD11T3-D26-C25-L250-Z02	●	26	2	25	250	35	10						
AEM90-BD11T3-D32-W32-L110-Z04-H	●	32	4	32	110	40	10						
AEM90-BD11T3-D32-C32-L130-Z04-H	●	32	4	32	130	40	10						
AEM90-BD11T3-D32-W32-L150-Z04	●	32	4	32	150	50	10						
AEM90-BD11T3-D40-W32-L110-Z04-H	●	40	4	32	110	35	10						
AEM90-BD1704-D25-W25-L100-Z02-H	●	25	2	25	100	35	15.7					BDMT 1704..	4015-M4x8
AEM90-BD1704-D25-W25-L150-Z02	●	25	2	25	150	50	15.7						
AEM90-BD1704-D32-W32-L110-Z03-H	●	32	3	32	110	40	15.7						
AEM90-BD1704-D32-W32-L150-Z03	●	32	3	32	150	50	15.7						
AEM90-BD1704-D40-W32-L110-Z04-H	●	40	4	32	110	40	15.7						
AEM90-BD1704-D40-W32-L150-Z04	●	40	4	32	150	40	15.7						

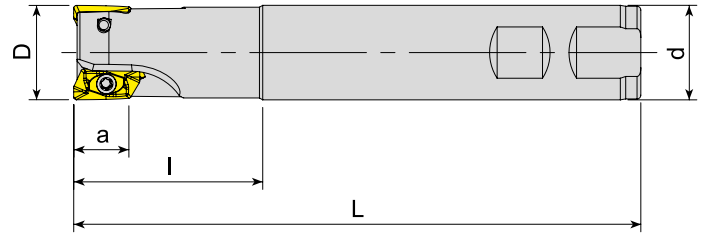

Takım Kodu Ordering Code Код для заказа	Stok Stock Наличие	Takım Ölçüleri (mm) Dimension (mm) Размеры (мм)						Kesici Uç Insert Пластина	Yedek Parçaları / Spare Parts / Запасные части		
		D	Z	d	L	I	a		Sıkma Vidası Screw Зажимной винт	Tork Anahtar Torx Key Торх Ключ	
AEM90-ED10T3-D16-W16-L120-Z02	●	16	2	16	120	30	30	EDPT 10T3..	3008-M2.5x5 3008-M2.5x6	80-T08	
AEM90-ED10T3-D20-W20-L120-Z02	●	20	2	20	120	30	30				
AEM90-ED1404-D20-W20-L150-Z02	●	20	2	20	150	50	14.5	EDPT 1404..	3008-M3x6	80-T08	
AEM90-ED1404-D25-W25-L150-Z02	●	25	2	25	150	50	14.5				
AEM90-ED1404-D30-C25-L150-Z03	●	30	3	25	150	50	14.5				

KNMTL Ucuna Uygunudur. / Compatible with KNMTL Insert. / Под пластину KNMTL

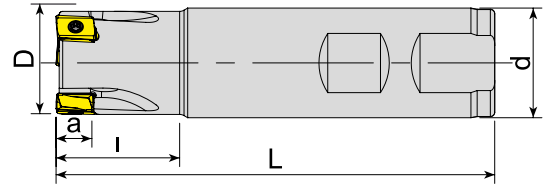

Takım Kodu Ordering Code Код для заказа	Stok Stock Наличие	Takım Ölçüleri (mm) Dimension (mm) Размеры (мм)						Kesici Uç Insert Пластина	Yedek Parçaları / Spare Parts / Запасные части		
		D	Z	d	L	I	a		Sıkma Vidası Screw Зажимной винт	Tork Anahtar Torx Key Торх Ключ	
AEM90-LN08-D16-W16-L100-Z02-H	●	16	2	16	100	28	8	LNMT 0804..	1707-U4-48x6 1707-U4-48x6.5 1707-U4-48x8.2	80-T07	
AEM90-LN08-D16-W16-L150-Z02	●	16	2	16	150	40	8				
AEM90-LN08-D20-W20-L100-Z03-H	●	20	3	20	100	28	8				
AEM90-LN08-D25-W25-L100-Z03-H	●	25	3	25	100	30	8				
AEM90-LN08-D32-W32-L110-Z05-H	●	32	5	32	110	30	8				

R: Sağ / Right / Правый L: Sol/Left/Левый

● Stokta / In Stock / В наличии ○ Stokta Yok / Non Stock Item / Нет в наличии

ISCR Ucuna Uygunudur. / Compatible with ISCR Insert. / Под пластину ISCR

Sipariş Örneği/Ordering Example/Образец заказа

1 ad./pcs./шт AEM90-ED10T3-D16-W16-L120-Z02

Kesme Hesabı : S 321 / Cutting Calculation : P 321 / Расчет режимов резания: стр. 321

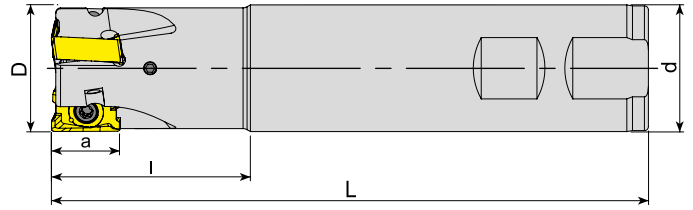

Takım Kodu Ordering Code Код для заказа	Stok Stock Наличие	Takım Ölçüleri (mm) Dimension (mm) Размеры (мм)						Kesici Uç Insert Пластина	Yedek Parçaları / Spare Parts / Запасные части		
		D	Z	d	L	l	a		Sıkma Vidası Screw Зажимной винт	Tork Anahtar Torx Key Торх Ключ	
AEM90-LN15T6-D25-W25-L150-Z02-H	●	25	2	25	150	50	15.5	LNGU 15T6..			
AEM90-LN15T6-D32-W32-L150-Z03-H	●	32	3	32	150	50	15.5				
AEM90-LN15T6-D40-W32-L150-Z03-H	●	40	3	32	150	40	15.5				

KNMNTL Ucuna Uygunur. / Compatible with KNMNTL Insert. / Под пластину KNMNTL

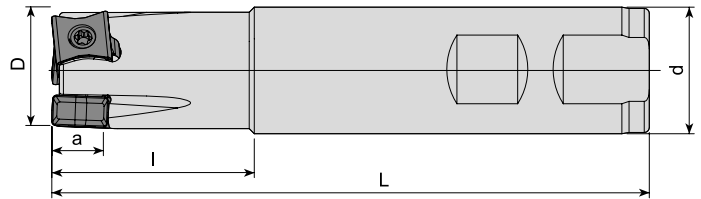

Takım Kodu Ordering Code Код для заказа	Stok Stock Наличие	Takım Ölçüleri (mm) Dimension (mm) Размеры (мм)						Kesici Uç Insert Пластина	Yedek Parçaları / Spare Parts / Запасные части		
		D	Z	d	L	l	a		Sıkma Vidası Screw Зажимной винт	Tork Anahtar Torx Key Торх Ключ	
AEM90-LN1106-D25-W25-L150-Z03	●	25	3	25	150	40	10	LNMT 1106..			
AEM90-LN1106-D32-W32-L150-Z04	●	32	4	32	150	40	10				
AEM90-LN1106-D40-W32-L150-Z05	●	40	5	32	150	40	10				

R: Sağ / Right / Правый L: Sol/Left/Левый

● Stokta / In Stock / В наличии ○ Stokta Yok / Non Stock Item / Нет в наличии

ISCR-XTC-GSC Ucuna Uygunur. / Compatible with ISCR-XTC-GSC Insert. / Под пластину ISCR-XTC-GSC

Sipariş Örneği/Ordering Example/Образец заказа

1 ad./pcs./шт AEM90-LN15T6-D25-W25-L150-Z02-H

Kesme Hesabı : S 321 / Cutting Calculation : P 321 / Расчет режимов резания: стр. 321

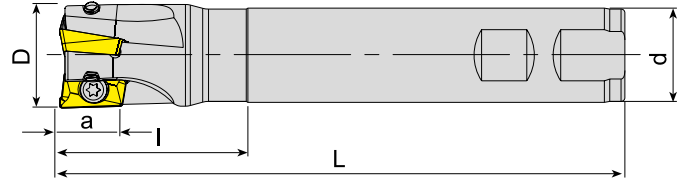

Takım Kodu Ordering Code Код для заказа	Stok Stock Наличие	Takım Ölçüleri (mm) Dimension (mm) Размеры (мм)						Kesici Uç Insert Пластина	Yedek Parçaları / Spare Parts / Запасные части	
		D	Z	d	L	l	a		Sıkma Vidası Screw Зажимной винт	Tork Anahtar Torx Key Торх Ключ
AEM90-R390.11-D16-W16-L100-Z02-H	●	16	2	16	100	30	10	R390-11T3..	3008-M2.5x5	80-T08
AEM90-R390.11-D16-W16-L150-Z02	●	16	2	16	150	50	10			
AEM90-R390.11-D16-W16-L150-Z02-H	●	16	2	16	150	50	10			
AEM90-R390.11-D20-W20-L090-Z02-H	●	20	2	20	90	30	10			
AEM90-R390.11-D20-W20-L100-Z03-H	●	20	3	20	100	30	10			
AEM90-R390.11-D20-W20-L150-Z03	●	20	3	20	150	50	10			
AEM90-R390.11-D20-W20-L150-Z03-H	●	20	3	20	150	50	10			
AEM90-R390.11-D20-C20-L150-Z03	●	20	3	20	150	30	10			
AEM90-R390.11-D22-W20-L090-Z02-H	●	22	2	20	90	30	10			
AEM90-R390.11-D25-C20-L150-Z03	●	25	3	20	150	40	10			
AEM90-R390.11-D25-W25-L100-Z03-H	●	25	3	25	100	30	10			
AEM90-R390.11-D25-W25-L150-Z03	●	25	3	25	150	50	10			
AEM90-R390.11-D25-W25-L150-Z03-H	●	25	3	25	150	50	10			
AEM90-R390.11-D30-W25-L150-Z04-H	●	30	4	25	150	30	10			
AEM90-R390.11-D32-C25-L200-Z03	●	32	3	25	200	40	10			
AEM90-R390.11-D32-W32-L150-Z05-H	●	32	5	32	150	50	10			
AEM90-R390.17-D25-W25-L150-Z02	●	25	2	25	150	50	15.4	R390-1704..	4015-M3.5x8	
AEM90-R390.17-D25-W25-L150-Z02-H	●	25	2	25	150	50	15.4			
AEM90-R390.17-D30-W25-L150-Z03	●	30	3	25	150	40	15.4			
AEM90-R390.17-D30-W25-L150-Z03-H	●	30	3	25	150	40	15.4			
AEM90-R390.17-D32-W32-L150-Z03-H	●	32	3	32	150	40	15.4			
AEM90-R390.18-D32-C32-L150-Z03	●	32	3	32	150	45	15.4	R390-1806..	4015-M4x11	

R: Sağ / Right / Правый L: Sol/Left/Левый

● Stokta / In Stock / В наличии ○ Stokta Yok / Non Stock Item / Нет в наличии

SNDVK Ucuna Uygundur. / Compatible with SNDVK Insert. / Под пластину SNDVK

Sipariş Örneği/Ordering Example/Образец заказа

1 ad./pcs./шт AEM90-R390.11-D16-W16-L100-Z02-H

Kesme Hesabı : S 321 / Cutting Calculation : P 321 / Расчет режимов резания: стр. 321

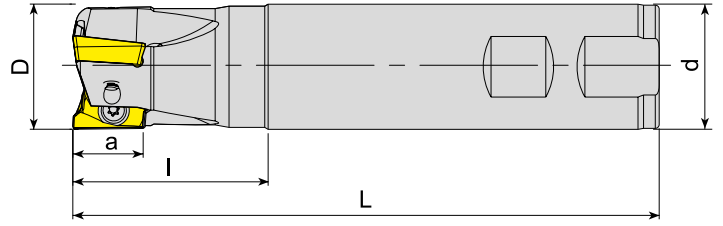

Takım Kodu Ordering Code Код для заказа	Stok Stock Наличие	Takım Ölçüleri (mm) Dimension (mm) Размеры (мм)						Kesici Uç Insert Пластина	Yedek Parçaları / Spare Parts / Залпасные части				
		D	Z	d	L	l	a		Sıkma Vidası Screw Зажимной винт	Tork Anahtar Torx Key Торх Ключ			
AEM90-RT07-D10-W10-L120-Z02	●	10	2	10	120	30	7	RT 0702	3006-M2x4	80-T06			
AEM90-RT07-D12-C12-L120-Z02	●	12	2	12	120	30	7						
AEM90-RT07-D12-W12-L120-Z02	●	12	2	12	120	30	7						
AEM90-RT07-D14-W12-L120-Z02	●	14	2	12	120	30	7						
AEM90-RT10-D16-C15-L160-Z02	●	16	2	15	160	30	10				RT 1003	3008-M2.5x6	80-T08
AEM90-RT10-D16-W16-L120-Z02-H	●	16	2	16	120	30	10						
AEM90-RT10-D16-W16-L150-Z02	●	16	2	16	150	50	10						
AEM90-RT10-D16-C16-L200-Z02	●	16	2	16	200	100	10						
AEM90-RT10-D17-W16-L160-Z02	●	17	2	16	160	30	10						
AEM90-RT10-D17-C16-L200-Z02	●	17	2	16	200	30	10						
AEM90-RT10-D18-W16-L120-Z02-H	●	18	2	16	120	30	10						
AEM90-RT10-D20-C19-L200-Z03	●	20	3	19	200	30	10						
AEM90-RT10-D20-C20-L110-Z03	●	20	3	20	110	30	10						
AEM90-RT10-D20-W20-L120-Z03-H	●	20	3	20	120	30	10						
AEM90-RT10-D20-W20-L150-Z03	●	20	3	20	150	50	10						
AEM90-RT10-D20-C20-L200-Z03	●	20	3	20	200	100	10						
AEM90-RT10-D21-W20-L200-Z03	●	21	3	20	200	30	10						
AEM90-RT10-D22-W20-L120-Z03-H	●	22	3	20	120	30	10						
AEM90-RT10-D22-C20-L150-Z03	●	22	3	20	150	30	10						
AEM90-RT10-D22-C20-L200-Z03	●	22	3	20	200	30	10						
AEM90-RT10-D25-W25-L120-Z04-H	●	25	4	25	120	40	10						
AEM90-RT10-D25-W25-L150-Z04	●	25	4	25	150	50	10						
AEM90-RT10-D25-C25-L200-Z04	●	25	4	25	200	100	10						
AEM90-RT10-D26-C25-L250-Z04	●	26	4	25	250	32	10						
AEM90-RT10-D32-W32-L120-Z05-H	●	32	5	32	120	50	10						
AEM90-RT10-D32-W32-L150-Z05	●	32	5	32	150	50	10						
AEM90-RT10-D32-C32-L200-Z05	●	32	5	32	200	100	10						
AEM90-RT10-D33-C32-L250-Z04	●	33	4	32	250	32	10						
AEM90-RT13-D32-C32-L250-Z04	●	32	4	32	250	50	13	RT 1304	3008-M3x8				
AEM90-RT16-D25-W25-L120-Z02-H	●	25	2	25	120	40	16	RT 1606	4015-M4x9	80-T15			
AEM90-RT16-D25-W25-L150-Z02	●	25	2	25	150	50	16						
AEM90-RT16-D25-C25-L200-Z02	●	25	2	25	200	100	16						
AEM90-RT16-D32-W32-L120-Z03-H	●	32	3	32	120	50	16						
AEM90-RT16-D32-W32-L150-Z03	●	32	3	32	150	50	16						
AEM90-RT16-D32-C32-L200-Z03	●	32	3	32	200	100	16						
AEM90-RT16-D32-C32-L250-Z03	●	32	3	32	250	100	16						
AEM90-RT16-D32-C32-L270-Z03	●	32	3	32	270	100	16						
AEM90-RT16-D40-W32-L120-Z04-H	●	40	4	32	120	50	16						
AEM90-RT16-D40-W32-L150-Z04	●	40	4	32	150	50	16						
AEM90-RT16-D40-C32-L200-Z04	●	40	4	32	200	100	16						
												4015-M4x11	

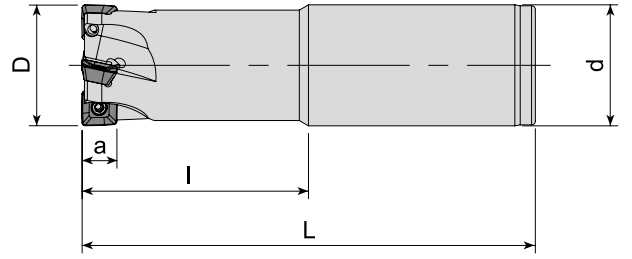

Takım Kodu Ordering Code Код для заказа	Stok Stock Наличие	Takım Ölçüleri (mm) Dimension (mm) Размеры (мм)						Kesici Uç Insert Пластина	Yedek Parçaları / Spare Parts / Запасные части		
		D	Z	d	L	l	a		Sıkma Vidası Screw Зажимной винт	Tork Anahtar Torx Key Торх Ключ	
AEM90-SE09-D25-C25-L120-Z03-H	●	25	3	25	120	60	6.7	SEET 09T3..	3008-M3x8	80-T08	
AEM90-SE09-D25-C25-L150-Z02	●	25	2	25	150	50	6.7				
AEM90-SE09-D32-C32-L120-Z04-H	●	32	4	32	120	60	6.7				
AEM90-SE09-D32-C32-L150-Z03	●	32	3	32	150	50	6.7				

ZCC Ucuna Uygunudur. / Compatible with ZCC Insert. / Под пластину ZCC

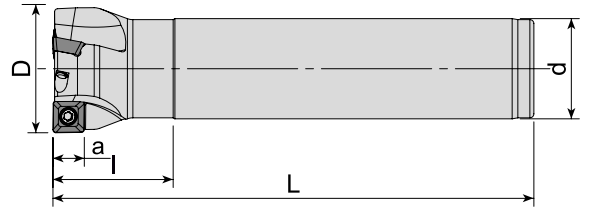

Takım Kodu Ordering Code Код для заказа	Stok Stock Наличие	Takım Ölçüleri (mm) Dimension (mm) Размеры (мм)						Kesici Uç Insert Пластина	Yedek Parçaları / Spare Parts / Запасные части		
		D	Z	d	L	l	a		Sıkma Vidası Screw Зажимной винт	Tork Anahtar Torx Key Торх Ключ	
AEM90-S00803-D20-C16-L110-Z02-H	●	20	2	16	110	25	7	SOMT 0803..	3008-M3x7	80-T08	
AEM90-S00803-D25-C20-L110-Z02-H	●	25	2	20	110	25	7				
AEM90-S00803-D32-C25-L120-Z03-H	●	32	3	25	120	30	7				

R: Sağ / Right / Правый L: Sol/Left/Левый

● Stokta / In Stock / В наличии ○ Stokta Yok / Non Stock Item / Нет в наличии

SMTM Ucuna Uygunudur. / Compatible with SMTM Insert. / Под пластину SMTM

Sipariş Örneği/Ordering Example/Образец заказа

1 ad./pcs./шт AEM90-SE09-D25-C25-L120-Z03-H

Kesme Hesabı : S 321 / Cutting Calculation : P 321 / Расчет режимов резания: стр. 321

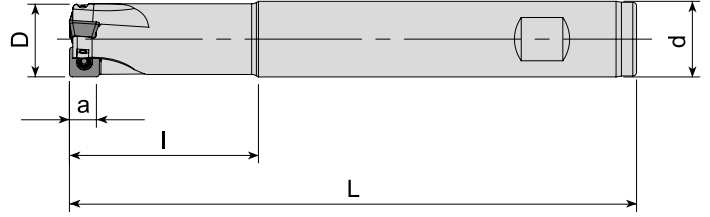

Takım Kodu Ordering Code Код для заказа	Stok Stock Наличие	Takım Ölçüleri (mm) Dimension (mm) Размеры (мм)						Yedek Parçaları / Spare Parts / Запасные части		
		D	Z	d	L	l	a	Kesici Uç Insert Пластина	Sıkma Vidası Screw Зажимной винт	Tork Anahtar Torx Key Торх Ключ
AEM90-SPGT0602-D16-W16-L150-Z02	●	16	2	16	150	50	5.5		3007-M2.2x5	80-T07
AEM90-SPGT07T3-D20-W20-L150-Z03	●	20	3	20	150	50	7	SPGT 07T308	3008-M2.5x6	80-T08
AEM90-SPGT07T3-D25-W25-L150-Z03	●	25	3	25	150	50	7			
AEM90-SPGT0904-D30-W32-L150-Z03	●	30	3	32	150	50	9	SPGT 090408	4015-M3.5x9	80-T15

ZCC Ucuna Uygunudur. / Compatiple with ZCC Insert. / Под пластину ZCC

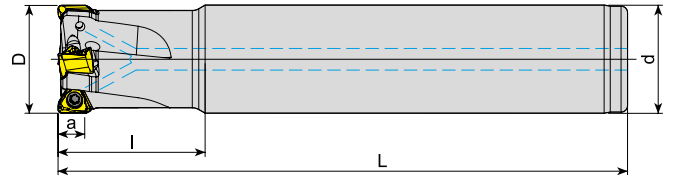

Takım Kodu Ordering Code Код для заказа	Stok Stock Наличие	Takım Ölçüleri (mm) Dimension (mm) Размеры (мм)						Yedek Parçaları / Spare Parts / Запасные части		
		D	Z	d	L	l	a	Kesici Uç Insert Пластина	Sıkma Vidası Screw Зажимной винт	Tork Anahtar Torx Key Торх Ключ
AEM90-TNG10-D20-C20-L125-Z02-H	●	20	2	20	125	29	5	TNGX 1004..	3008-M2.5x6	80-T08
AEM90-TNG10-D20-C20-L125-Z03-H	●	20	3	20	125	29	5			
AEM90-TNG10-D20-C20-L150-Z03-H	○	20	3	20	150	50	5			
AEM90-TNG10-D25-C25-L150-Z03-H	●	25	3	25	150	34	5			
AEM90-TNG10-D25-C25-L150-Z04-H	●	25	4	25	150	34	5			
AEM90-TNG10-D25-C25-L170-Z04-H	○	25	4	25	170	50	5			
AEM90-TNG10-D32-C32-L170-Z04-H	●	32	4	32	170	37	5			
AEM90-TNG10-D32-C32-L170-Z05-H	○	32	5	32	170	37	5			

R: Sağ / Right / Правый L: Sol/Left/Левый
● Stokta / In Stock / В наличии ○ Stokta Yok / Non Stock Item / Нет в наличии
PRMT Ucuna Uygunudur. / Compatiple with PRMT Insert. / Под пластину PRMT

Sipariş Örneği/Ordering Example/Образец заказа
1 ad./pcs./шт AEM90-SPGT0602-D16-W16-L150-Z02
Kesme Hesabı : S 321 / Cutting Calculation : P 321 / Расчет режимов резания: стр. 321



90°

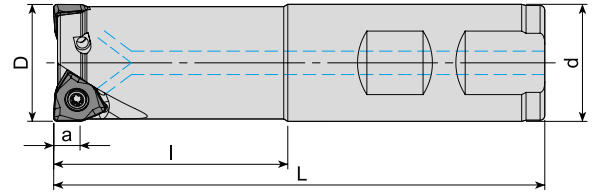

Takım Kodu Ordering Code Код для заказа	Stok Stock Наличие	Takım Ölçüleri (mm) Dimension (mm) Размеры (мм)						Kesici Uç Insert Пластина	Yedek Parçaları / Spare Parts / Залпасные части		
		D	Z	d	L	l	a		Sıkma Vidası Screw Зажимной винт	Tork Anahtar Torx Key Торх Ключ	
AEM90-WN0604Z-D25-W25-L150-Z02-H	●	25	2	25	150	50	5.7	WNHU 0604..		3008-M3x8	
AEM90-WN0604Z-D32-W32-L150-Z03-H	●	32	3	32	150	50	5.7				
AEM90-WN0604Z-D40-W32-L150-Z04-H	●	40	4	32	150	35	5.7				

ZCC Ucuna Uygunur. / Compatible with ZCC Insert. / Под пластину ZCC

90°

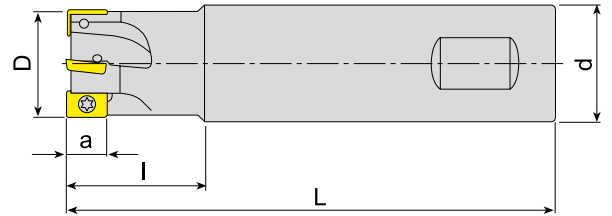

Takım Kodu Ordering Code Код для заказа	Stok Stock Наличие	Takım Ölçüleri (mm) Dimension (mm) Размеры (мм)						Kesici Uç Insert Пластина	Yedek Parçaları / Spare Parts / Залпасные части		
		D	Z	d	L	l	a		Sıkma Vidası Screw Зажимной винт	Tork Anahtar Torx Key Торх Ключ	
AEM90-XD11T3-D16-W16-L150-Z02	●	16	2	16	150	30	10	XD.T 11T3..	3008-M2.5x5		
AEM90-XD11T3-D17-C16-L150-Z02	●	17	2	16	150	30	10				
AEM90-XD11T3-D20-W20-L150-Z03	●	20	3	20	150	50	10				
AEM90-XD11T3-D21-C20-L080-Z03-H	●	21	3	20	80	25	10				
AEM90-XD11T3-D21-C20-L150-Z03	●	21	3	20	150	30	10				
AEM90-XD11T3-D25-W25-L150-Z04	●	25	4	25	150	50	10				
AEM90-XD11T3-D30-W25-L120-Z04	●	30	4	25	120	30	10				
AEM90-XD11T3-D32-W32-L150-Z04	●	32	4	32	150	50	10				
AEM90-XD11T3-D33-C20-L080-Z04-H	●	33	4	20	80	30	10				
									3008-M2.5x6		

R: Sağ / Right / Правый L: Sol/Left/Левый

● Stokta / In Stock / В наличии ○ Stokta Yok / Non Stock Item / Нет в наличии

CRTZT Ucuna Uygunur. / Compatible with CRTZT Insert. / Под пластину CRTZT

Sipariş Örneği/Ordering Example/Образец заказа

1 ad./pcs./шт AEM90-XD11T3-D16-W16-L150-Z02

Kesme Hesabı : S 321 / Cutting Calculation : P 321 / Расчет режимов резания: стр. 321



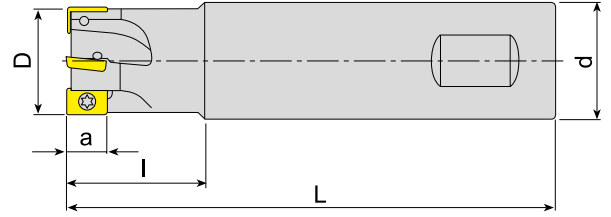

Takım Kodu Ordering Code Код для заказа	Stok Stock Наличие	Takım Ölçüleri (mm) Dimension (mm) Размеры (мм)						Kesici Uç Insert Пластина	Yedek Parçaları / Spare Parts / Запасные части		
		D	Z	d	L	l	a		Sıkma Vidası Screw Зажимной винт	Tork Anahtar Torx Key Торх Ключ	
AEM90-XC13-D20-W20-L150-Z02	●	20	2	20	150	60	13	XCKX 13T3..	3008-M3x6	80-T08	
AEM90-XC13-D25-W25-L150-Z03	●	25	3	25	150	60	13		3008-M3x8		
AEM90-XC13-D32-W32-L150-Z04	●	32	4	32	150	60	13				

SC Ucuna Uygunur. / Compatiple with SC Insert. / Под пластину SC

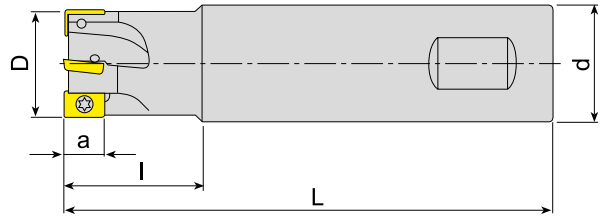

Takım Kodu Ordering Code Код для заказа	Stok Stock Наличие	Takım Ölçüleri (mm) Dimension (mm) Размеры (мм)						Kesici Uç Insert Пластина	Yedek Parçaları / Spare Parts / Запасные части		
		D	Z	d	L	l	a		Sıkma Vidası Screw Зажимной винт	Tork Anahtar Torx Key Торх Ключ	
AEM90-X006-D10-C12-L120-Z02	●	10	2	12	120	50	5	X0.. 0602..	3006-M1.8x4	80-T06	
AEM90-X006-D12-C12-L120-Z02	●	12	2	12	120	25	5				
AEM90-X009-D16-W16-L150-Z02	●	16	2	16	150	50	8				
AEM90-X009-D20-W20-L150-Z03	●	20	3	20	150	50	8	X0.. 0903..	3008-M2.5x5	80-T08	
AEM90-X012-D20-W20-L150-Z02	●	20	2	20	150	50	11	X0.. 1204..	3010-M3.5x7	80-T10	
AEM90-X012-D20-C20-L200-Z02	●	20	2	20	200	100	11				
AEM90-X012-D22-W20-L150-Z02	●	22	2	20	150	30	11				
AEM90-X012-D25-W25-L150-Z03	●	25	3	25	150	50	11				
AEM90-X012-D25-C25-L200-Z03	●	25	3	25	200	100	11				
AEM90-X012-D32-C25-L150-Z04	●	32	4	25	150	40	11				
AEM90-X012-D32-W32-L150-Z04	●	32	4	32	150	50	11				
AEM90-X012-D32-C32-L250-Z04	●	32	4	32	250	100	11				

R: Sağ / Right / Правый L: Sol/Left/Левый

● Stokta / In Stock / В наличии ○ Stokta Yok / Non Stock Item / Нет в наличии



SC Ucuna Uygunur. / Compatiple with SC Insert. / Под пластину SC

Sipariş Örneği/Ordering Example/Образец заказа

1 ad./pcs./шт AEM90-XC13-D20-W20-L150-Z02

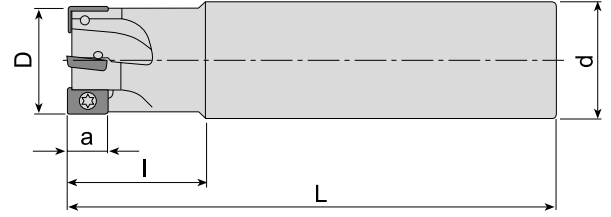

Kesme Hesabı : S 321 / Cutting Calculation : P 321 / Расчет режимов резания: стр. 321

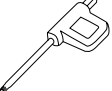

Takım Kodu Ordering Code Код для заказа	Stok Stock Наличие	Takım Ölçüleri (mm) Dimension (mm) Размеры (мм)						Kesici Uç Insert Пластина	Yedek Parçaları / Spare Parts / Запасные части		
		D	Z	d	L	l	a		Sıkma Vidası Screw Зажимной винт	Tork Anahtar Torx Key Торх Ключ	
AEM90-ZC1003-D16-C14-L150-Z02	●	16	2	14	150	25	9				
AEM90-ZC1003-D16-C14-L200-Z02	●	16	2	14	200	25	9				
AEM90-ZC1003-D16-C15-L150-Z02	●	16	2	15	150	25	9				
AEM90-ZC1003-D16-C16-L150-Z02	●	16	2	16	150	25	9				
AEM90-ZC1003-D17-C16-L150-Z02	●	17	2	16	150	25	9				
AEM90-ZC1003-D17-C16-L200-Z02	●	17	2	16	200	25	9				
AEM90-ZC1003-D20-C18-L150-Z03	●	20	3	18	150	25	9				
AEM90-ZC1003-D20-C18-L200-Z02	●	20	2	18	200	25	9				
AEM90-ZC1003-D20-C20-L150-Z03	●	20	3	20	150	40	9				
AEM90-ZC1003-D20-C18-L200-Z03	●	20	3	18	200	25	9				
AEM90-ZC1003-D21-C20-L150-Z02	●	21	2	20	150	30	9				
AEM90-ZC1003-D21-C20-L150-Z03	●	21	3	20	150	30	9				
AEM90-ZC1003-D21-C20-L200-Z03	●	21	3	20	200	30	9				
AEM90-ZC1003-D25-C20-L150-Z03	●	25	3	20	150	30	9				
AEM90-ZC1003-D25-C20-L200-Z03	●	25	3	20	200	30	9				
AEM90-ZC1003-D25-C25-L150-Z03	●	25	3	25	150	40	9				
AEM90-ZC1003-D26-C25-L170-Z03	●	26	3	25	170	25	9				
AEM90-ZC1003-D26-C25-L200-Z03	●	26	3	25	200	25	9				
AEM90-ZC1003-D32-C25-L180-Z04	●	32	4	25	180	30	9				
AEM90-ZC1003-D33-C32-L200-Z04	●	33	4	32	200	25	9				

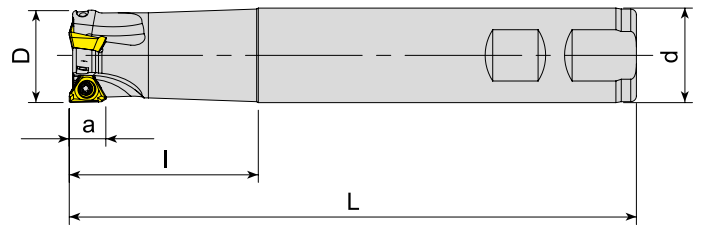
DJT Ucuna Uygundur. / Compatible with DJT Insert. / Под пластину DJT



Takım Kodu Ordering Code Код для заказа	Stok Stock Наличие	Takım Ölçüleri (mm) Dimension (mm) Размеры (мм)						Kesici Uç Insert Пластина	Yedek Parçaları / Spare Parts / Запасные части		
		D	Z	d	L	l	a		Sıkma Vidası Screw Зажимной винт	Tork Anahtar Torx Key Торх Ключ	
AEM90-3P1004-D20-W20-L150-Z02	●	20	2	20	150	40	7				
AEM90-3P1004-D25-W25-L150-Z03	●	25	3	25	150	40	7				
AEM90-3P1505-D32-W32-L150-Z03	●	32	3	32	150	50	11				
AEM90-3P1505-D40-W32-L150-Z04	●	40	4	32	150	35	11				

R: Sağ / Right / Правый L: Sol/Left/Левый
● Stokta / In Stock / В наличии ○ Stokta Yok / Non Stock Item / Нет в наличии
TGTC Ucuna Uygundur. / Compatible with TGTC Insert. / Под пластину TGTC

Sipariş Örneği/Ordering Example/Образец заказа
1 ad./pcs./шт AEM90-ZC1003-D16-C14-L150-Z02
Kesme Hesabı : S 321 / Cutting Calculation : P 321 / Расчет режимов резания: стр. 321

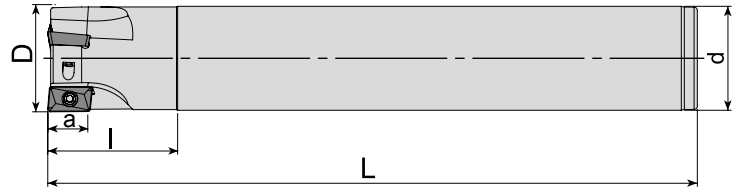

Takım Kodu Ordering Code Код для заказа	Stok Stock Наличие	Takım Ölçüleri (mm) Dimension (mm) Размеры (мм)						Kesici Uç Insert Пластина	Yedek Parçaları / Spare Parts / Запасные части		
		D	Z	d	L	l	a		Sıkma Vidası Screw Зажимной винт	Tork Anahtar Torx Key Торх Ключ	
AEM90-ZP13T3-D26-C25-L200-Z02	●	26	2	25	200	35	13	ZPMT 13T3..			
AEM90-ZP13T3-D26-C25-L200-Z03	●	26	3	25	200	35	13				
AEM90-ZP13T3-D26-C25-L250-Z02	●	26	2	25	250	35	13				
AEM90-ZP13T3-D33-C32-L200-Z03	●	33	3	32	200	40	13				
AEM90-ZP13T3-D33-C32-L250-Z03	●	33	3	32	250	40	13				

DJT Ucuna Uygunudur. / Compatible with DJT Insert. / Под пластину DJT

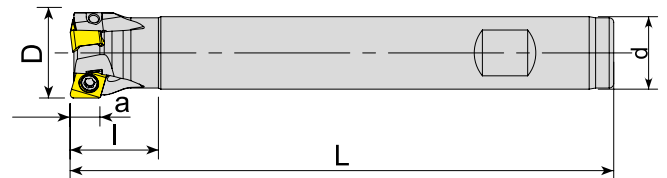

Takım Kodu Ordering Code Код для заказа	Stok Stock Наличие	Takım Ölçüleri (mm) Dimension (mm) Размеры (мм)						Kesici Uç Insert Пластина	Yedek Parçaları / Spare Parts / Запасные части		
		D	Z	d	L	l	a		Sıkma Vidası Screw Зажимной винт	Tork Anahtar Torx Key Торх Ключ	
AEM90-4N06-D16-W16-L120-Z02-H	●	16	2	16	120	25	6	4NKT 0603..			
AEM90-4N06-D16-W16-L160-Z02	●	16	2	16	160	25	6				
AEM90-4N06-D20-W16-L120-Z03-H	●	20	3	16	120	20	6				
AEM90-4N06-D20-W16-L160-Z03	●	20	3	16	160	20	6				

R: Sağ / Right / Правый L: Sol/Left/Левый
● Stokta / In Stock / В наличии ○ Stokta Yok / Non Stock Item / Нет в наличии
TGTC Ucuna Uygunudur. / Compatible with TGTC Insert. / Под пластину TGTC

Sipariş Örneği/Ordering Example/Образец заказа
1 ad./pcs./шт AEM90-ZP13T3-D26-C25-L200-Z02
Kesme Hesabı : S 321 / Cutting Calculation : P 321 / Расчет режимов резания: стр. 321

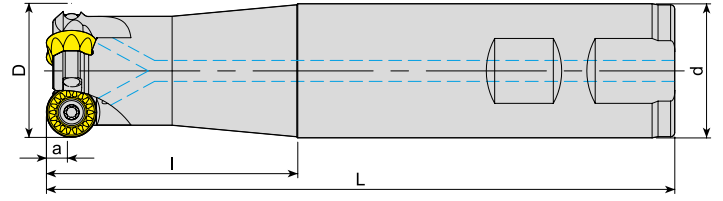

Takım Kodu Ordering Code Код для заказа	Stok Stock Наличие	Takım Ölçüleri (mm) Dimension (mm) Размеры (мм)						Kesici Uç Insert Пластина	Yedek Parçaları / Spare Parts / Запасные части				
		D	Z	d	L	l	a		Sıkma Vidası Screw Зажимной винт	Baskı Parçası Wedge Clamp Прижим	Baskı Vidası Clamp Screw Зажимной винт	Tork Anahtar Torx Key Торх Ключ	
AEMR-RP08T2M-D20-W20-L150-Z02-H	●	20	2	20	150	60	4	RPMT 08T2..	3008-M2.5x6	-	-	80-T08	
AEMR-RP08T2M-D25-W25-L200-Z03-H	●	25	3	25	200	100	4						
AEMR-RP10T3M-D25-W25-L200-Z02-H	●	25	2	25	200	100	5	RPMT 10T3..	4015-M3.5x9	-	-	80-T15	
AEMR-RP1204M-D32-W32-L150-Z03-H	●	32	3	32	150	60	6	RPMT 1204..	4015-M4x9	-	-		
AEMR-RP1204M-D32-W32-L200-Z03-H	●	32	3	32	200	100	6						

MTSBSH Ucuna Uygunudur. / Compatible with MTSBSH Insert. / Под пластину MTSBSH

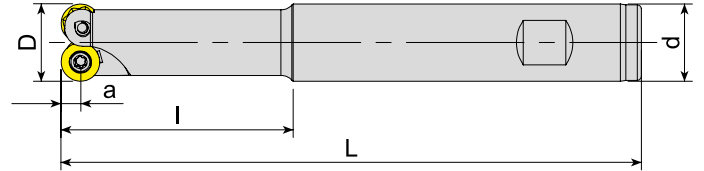

Takım Kodu Ordering Code Код для заказа	Stok Stock Наличие	Takım Ölçüleri (mm) Dimension (mm) Размеры (мм)						Kesici Uç Insert Пластина	Yedek Parçaları / Spare Parts / Запасные части		
		D	Z	d	L	l	a		Sıkma Vidası Screw Зажимной винт	Tork Anahtar Torx Key Торх Ключ	
AEMR-RY08-D16-W16-L150-Z02	●	16	2	16	150	55	4	RYMX 0803..	4010-M3x6	80-T10	
AEMR-RY10-D20-W20-L150-Z02	●	20	2	20	150	60	5				
AEMR-RY10-D20-C20-L200-Z02	●	20	2	20	200	100	5	RYMX 1004..	4015-M3.5x8	80-T15	
AEMR-RY10-D21-W20-L200-Z02-H	●	21	2	20	200	30	5				
AEMR-RY10-D25-W25-L150-Z02	●	25	2	25	150	60	5				
AEMR-RY10-D25-W25-L150-Z03	●	25	3	25	150	60	5				
AEMR-RY10-D26-W25-L200-Z02-H	●	26	2	25	200	60	5				
AEMR-RY10-D32-W32-L160-Z04-H	●	32	4	32	160	60	5				
AEMR-RY12-D32-C25-L160-Z03	●	32	3	25	160	30	6				RYMX 1205..

R: Sağ / Right / Правый L: Sol/Left/Левый

● Stokta / In Stock / В наличии ○ Stokta Yok / Non Stock Item / Нет в наличии

TGTC Ucuna Uygunudur. / Compatible with TGTC Insert. / Под пластину TGTC

Sipariş Örneği/Ordering Example/Образец заказа

1 ad./pcs./шт AEMR-RP08T2M-D20-W20-L150-Z02-H

Kesme Hesabı : S 321 / Cutting Calculation : P 321 / Расчет режимов резания: стр. 321



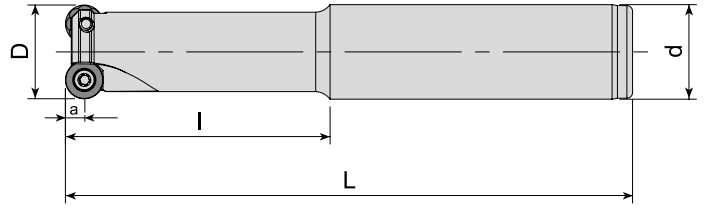

Takım Kodu Ordering Code Код для заказа	Stok Stock Наличие	Takım Ölçüleri (mm) Dimension (mm) Размеры (мм)					Kesici Uç Insert Пластина	Yedek Parçaları / Spare Parts / Запасные части				
		D	Z	d	L	l		a	Sıkma Vidası Screw Зажимной винт	Baskı Parçası Wedge Clamp Прижим	Baskı Vidası Clamp Screw Зажимной винт	Tork Anahtar Torx Key Торх Ключ
AEMR-QP10T3-D20-C20-L150-Z01-H	●	20	1	20	150	70	5	QP.. 10T3..	4015-M3.5x9	-	-	80-T15
AEMR-QP10T3-D25-C25-L120-Z02-H	●	25	2	25	120	40	5					
AEMR-QP10T3-D25-C25-L150-Z02-H	●	25	2	25	150	70	5					
AEMR-QP10T3-D25-C25-L170-Z02	●	25	2	25	170	90	5					
AEMR-QP10T3-D32-C32-L150-Z03-H	●	32	3	32	150	70	5					
AEMR-QP10T3-D32-C32-L170-Z03	●	32	3	32	170	90	5	QP.. 1204..	4015-M4x9	-	-	
AEMR-QP1204-D25-C25-L150-Z02-H	●	25	2	25	150	70	6					

SMTM Ucuna Uygunur. / Compatible with SMTM Insert. / Под пластину SMTM

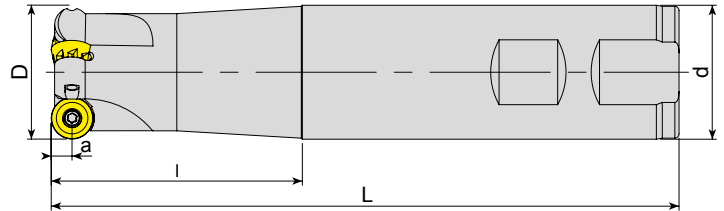

Takım Kodu Ordering Code Код для заказа	Stok Stock Наличие	Takım Ölçüleri (mm) Dimension (mm) Размеры (мм)					Kesici Uç Insert Пластина	Yedek Parçaları / Spare Parts / Запасные части				
		D	Z	d	L	l		a	Sıkma Vidası Screw Зажимной винт	Baskı Parçası Wedge Clamp Прижим	Baskı Vidası Clamp Screw Зажимной винт	Tork Anahtar Torx Key Торх Ключ
AEMR-RP10T3-D25-W25-L125-Z02	●	25	2	25	125	60	5	RPNX 10T3..	4010-M3x8	-	-	80-T10
AEMR-RP10T3-D25-W25-L150-Z02	●	25	2	25	150	60	5					
AEMR-RP10T3-D32-W32-L150-Z03	●	32	3	32	150	60	5					

R: Sağ / Right / Правый L: Sol/Left/Левый

● Stokta / In Stock / В наличии ○ Stokta Yok / Non Stock Item / Нет в наличии

CRTZT Ucuna Uygunur. / Compatible with CRTZT Insert. / Под пластину CRTZT

Sipariş Örneği/Ordering Example/Образец заказа

1 ad./pcs./шт AEMR-QP10T3-D20-C20-L150-Z01-H

Kesme Hesabı : S 321 / Cutting Calculation : P 321 / Расчет режимов резания: стр. 321

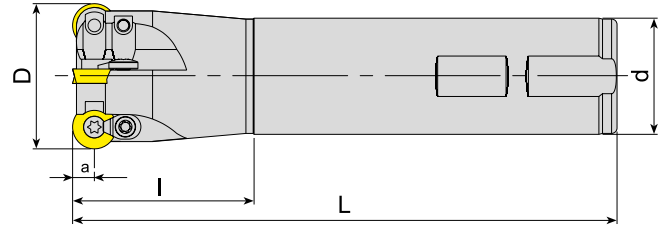

Takım Kodu Ordering Code Код для заказа	Stok Stock Наличие	Takım Ölçüleri (mm) Dimension (mm) Размеры (мм)						Kesici Uç Insert Пластина	Yedek Parçaları / Spare Parts / Запасные части								
		D	Z	d	L	l	a		Sıkma Vidası Screw Зажимной винт	Baskı Parçası Wedge Clamp Прижим	Baskı Vidası Clamp Screw Зажимной винт	Tork Anahtar Torx Key Торх Ключ					
AEMR-RD0501-D08-W10-L100-Z01-H	●	8	1	10	100	20	2.5	RD.. 0501	3006-M2x3.6			80-T06					
AEMR-RD0501-D10-W12-L100-Z02-H	●	10	2	12	100	20	2.5						3006-M2x4				
AEMR-RD0501-D12-W12-L120-Z02-H	●	12	2	12	120	20	2.5										
AEMR-RD0803-D16-W16-L150-Z02	●	16	2	16	150	60	4	RD.. 0803	3008-M3x6	-	-	80-T08					
AEMR-RD0803-D16-C20-L200-Z02	●	16	2	20	200	60	4										
AEMR-RD0803-D20-W20-L150-Z03	●	20	3	20	150	60	4	RD.. 08T2	3008-M2.5x6								
AEMR-RD08T2-D16-W16-L150-Z02	●	16	2	16	150	60	4										
AEMR-RD08T2-D20-W20-L150-Z02	●	20	2	20	150	60	4	RD.. 1003									
AEMRC-RD1003-D20-W20-L150-Z02	●	20	2	20	150	60	5										
AEMRC-RD1003-D20-C20-L160-Z02	●	20	2	20	160	70	5										
AEMRC-RD1003-D20-C20-L250-Z02	●	20	2	20	250	150	5										
AEMRC-RD1003-D21-C20-L160-Z02	●	21	2	20	160	70	5										
AEMRC-RD1003-D25-W25-L150-Z02	●	25	2	25	150	60	5										
AEMRC-RD1003-D25-C25-L160-Z02	●	25	2	25	160	70	5										
AEMRC-RD1003-D25-W25-L200-Z02	●	25	2	25	200	100	5										
AEMRC-RD1003-D25-C25-L200-Z02	●	25	2	25	200	100	5										
AEMRC-RD1003-D25-C25-L250-Z02	●	25	2	25	250	150	5										
AEMRC-RD1003-D26-C25-L160-Z02	●	26	2	25	160	70	5										
AEMRC-RD1003-D32-W32-L150-Z03	●	32	3	32	150	60	5										
AEMRC-RD1003-D32-C32-L250-Z02	●	32	2	32	250	150	5										
AEMRC-RD1003-D33-C32-L160-Z03	●	33	3	32	160	70	5										
AEMRC-RD1003-D40-W32-L150-Z04	●	40	4	32	150	35	5										
AEMRC-RD1003-D40-C32-L250-Z02	●	40	2	32	250	35	5										
AEMRC-RD10T3-D20-C20-L150-Z02	●	20	2	20	150	60	5						RD.. 10T3	4015-M3.5x9	ACK-15	4015-M3.5x11	80-T15
AEMRC-RD10T3-D20-W20-L150-Z02	●	20	2	20	150	60	5										
AEMRC-RD10T3-D25-C25-L150-Z02	●	25	2	25	150	60	5										
AEMRC-RD10T3-D25-W25-L150-Z02	●	25	2	25	150	60	5										
AEMRC-RD10T3-D32-W32-L150-Z03	●	32	3	32	150	60	5										
AEMRC-RD12T3-D25-W25-L150-Z02	●	25	2	25	150	60	6	RD.. 12T3									
AEMRC-RD12T3-D25-W25-L200-Z02	●	25	2	25	200	100	6										
AEMRC-RD12T3-D25-C25-L250-Z02	●	25	2	25	250	150	6										
AEMRC-RD12T3-D25-C25-L300-Z02	●	25	2	25	300	200	6										
AEMRC-RD12T3-D32-W32-L150-Z03	●	32	3	32	150	60	6										
AEMRC-RD12T3-D32-C32-L250-Z02	●	32	2	32	250	150	6										
AEMRC-RD12T3-D40-W32-L150-Z04	●	40	4	32	150	50	6	RD.. 1204									
AEMRC-RD12T3-D40-C32-L250-Z02	●	40	2	32	250	50	6										
AEMRC-RD1204-D32-C32-L160-Z03	●	32	3	32	160	70	6										
AEMRC-RD1204-D32-W32-L160-Z03	●	32	3	32	160	50	6										
AEMRC-RD1204-D33-C32-L160-Z03	●	33	3	32	160	70	6	RD.. 1604	4015-M4.5x11	ACK-05	4015-M4x11						
AEMRC-RD1604-D40-W32-L150-Z02	●	40	2	32	150	35	8										

R: Sağ / Right / Правый L: Sol/Left/Левый

● Stokta / In Stock / В наличии ○ Stokta Yok / Non Stock Item / Нет в наличии

ISO Uçuna Uygundur. / Compatible with ISO Insert. / Под пластину ISO

Sipariş Örneği/Ordering Example/Образец заказа

1 ad./pcs./шт AEMR-RD0501-D08-W10-L100-Z01-H

Kesme Hesabı : S 321 / Cutting Calculation : P 321 / Расчет режимов резания: стр. 321



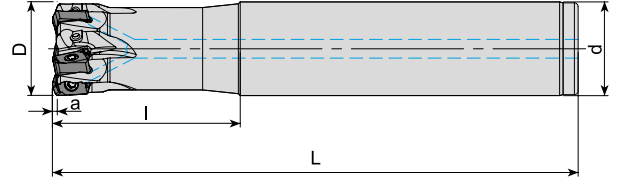

Takım Kodu Ordering Code Код для заказа	Stok Stock Наличие	Takım Ölçüleri (mm) Dimension (mm) Размеры (мм)						Kesici Uç Insert Пластина	Yedek Parçaları / Spare Parts / Запасные части		
		D	Z	d	L	l	a		Sıkma Vidası Screw Зажимной винт	Tork Anahtar Torx Key Торх Ключ	
AHFM-BN10T3-D16-C16-L100-Z02-H	●	16	2	16	100	30	1	BNGX 10T3..	3008-M2.5x6	80-T08	
AHFM-BN10T3-D16-C16-L150-Z02-H	●	16	2	16	150	50	1				
AHFM-BN10T3-D20-C20-L130-Z03-H	●	20	3	20	130	40	1				
AHFM-BN10T3-D20-C20-L130-Z04-H	●	20	4	20	130	40	1				
AHFM-BN10T3-D20-C20-L160-Z03-H	●	20	3	20	160	80	1				
AHFM-BN10T3-D25-C25-L140-Z04-H	●	25	4	25	140	50	1				
AHFM-BN10T3-D25-C25-L140-Z05-H	●	25	5	25	140	50	1				
AHFM-BN10T3-D25-C25-L180-Z04-H	●	25	4	25	180	100	1				
AHFM-BN10T3-D32-C32-L150-Z05-H	●	32	5	32	150	70	1				
AHFM-BN10T3-D32-C32-L150-Z06-H	●	32	6	32	150	70	1				
AHFM-BN10T3-D35-C32-L200-Z06-H	●	35	6	32	200	50	1				

PRMT Ucuna Uygundur. / Compatiple with PRMT Insert. / Под пластину PRMT

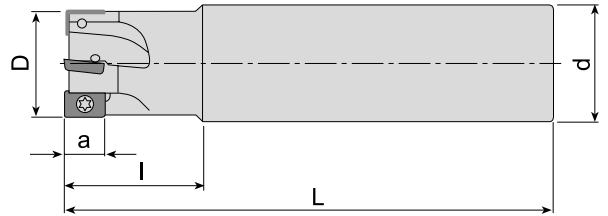

Takım Kodu Ordering Code Код для заказа	Stok Stock Наличие	Takım Ölçüleri (mm) Dimension (mm) Размеры (мм)						Kesici Uç Insert Пластина	Yedek Parçaları / Spare Parts / Запасные части		
		D	Z	d	L	l	a		Sıkma Vidası Screw Зажимной винт	Tork Anahtar Torx Key Торх Ключ	
AHFM-E00602-D10-C10-L080-Z02	●	10	2	10	80	20	-	E0.. 0602.. ZOMT 0602..	3006-M1.8x4	80-T06	
AHFM-E00602-D10-C09-L120-Z02	●	10	2	9	120	15	-				
AHFM-E00602-D10-C10-L120-Z02	●	10	2	10	120	60	-				
AHFM-E00602-D12-C12-L080-Z02	●	12	2	12	80	20	-				
AHFM-E00602-D12-C12-L080-Z03	●	12	3	12	80	20	-				
AHFM-E00602-D12-C11-L120-Z02	●	12	2	11	120	15	-				
AHFM-E00602-D12-C11-L120-Z03	●	12	3	11	120	15	-				
AHFM-E00602-D12-C12-L120-Z02	●	12	2	12	120	60	-				
AHFM-E00602-D12-C12-L120-Z03	●	12	3	12	120	60	-				
AHFM-E00602-D16-C16-L150-Z04	●	16	4	16	150	60	-				

R: Sağ / Right / Правый L: Sol/Left/Левый
● Stokta / In Stock / В наличии ○ Stokta Yok / Non Stock Item / Нет в наличии
DJT Ucuna Uygundur. / Compatiple with DJT Insert. / Под пластину DJT

Sipariş Örneği/Ordering Example/Образец заказа
1 ad./pcs./шт AHFM-BN10T3-D16-C16-L100-Z02-H
Kesme Hesabı : S 321 / Cutting Calculation : P 321 / Расчет режимов резания: стр. 321

S-SİSTEM HIZLI İLERLEMELİ PARMAK FREZELER
S-SYSTEM HIGHFEED END MILLS
S-ТИП ВЫСОКОПРОИЗВОДИТЕЛЬНЫЕ КОНЦЕВЫЕ ФРЕЗЫ

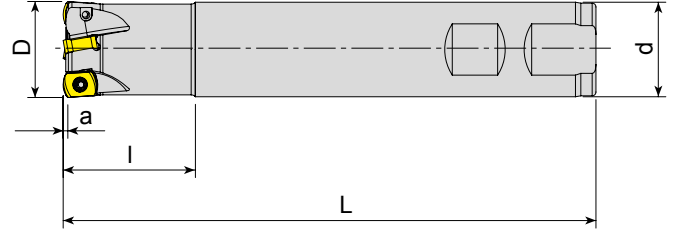

Takım Kodu Ordering Code Код для заказа	Stok Stock Наличие	Takım Ölçüleri (mm) Dimension (mm) Размеры (мм)						Kesici Uç Insert Пластина	Yedek Parçaları / Spare Parts / Запасные части		
		D	Z	d	L	l	a		Sıkma Vidası Screw Зажимной винт	Tork Anahtar Torx Key Торх Ключ	
AHFM-BL0603-D16-C15-L150-Z02	●	16	2	15	150	20	1	BLMP 0603..			
AHFM-BL0603-D16-C16-L100-Z02-H	●	16	2	16	100	30	1				
AHFM-BL0603-D16-C16-L150-Z02	●	16	2	16	150	50	1				
AHFM-BL0603-D17-C16-L150-Z02	●	17	2	16	170	20	1				
AHFM-BL0603-D17-W16-L170-Z02	●	17	2	16	170	20	1				
AHFM-BL0603-D17-W16-L170-Z02-H	●	17	2	16	170	20	1				
AHFM-BL0603-D18-C16-L150-Z02	●	18	2	16	150	20	1				
AHFM-BL0603-D18-W16-L150-Z02-H	●	18	2	16	150	20	1				
AHFM-BL0603-D20-C20-L130-Z03	●	20	3	20	130	50	1				
AHFM-BL0603-D20-C20-L160-Z03	●	20	3	20	160	50	1				
AHFM-BL0603-D21-C20-L200-Z03	●	21	3	20	200	25	1				
AHFM-BL0603-D21-W20-L200-Z03	●	21	3	20	200	25	1				
AHFM-BL0603-D25-C25-L250-Z04	●	25	4	25	250	40	1				
AHFM-BL0603-D26-C25-L200-Z04	●	26	4	25	200	35	1				
AHFM-BL0603-D26-W25-L200-Z04	●	26	4	25	200	35	1				
AHFM-BL0603-D32-C32-L150-Z05	●	32	5	32	150	70	1				
AHFM-BL0603-D32-C32-L200-Z05	●	32	5	32	200	120	1				
AHFM-BL0603-D33-C32-L200-Z05	●	33	5	32	200	40	1				

TGTC Uçuna Uygundur. / Compatiple with TGTC Insert. / Под пластину TGTC

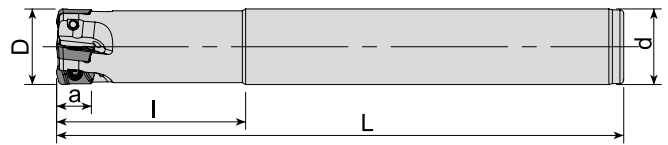

Takım Kodu Ordering Code Код для заказа	Stok Stock Наличие	Takım Ölçüleri (mm) Dimension (mm) Размеры (мм)						Kesici Uç Insert Пластина	Yedek Parçaları / Spare Parts / Запасные части		
		D	Z	d	L	l	a		Sıkma Vidası Screw Зажимной винт	Tork Anahtar Torx Key Торх Ключ	
AHFM-EP1003-D16-C16-L150-Z02-H	●	16	2	16	150	50	1	EP.. 1003.. ZPMT 1003.. YPHW 1003..			
AHFM-EP1003-D17-C16-L150-Z02-H	●	17	2	16	150	20	1				
AHFM-EP1003-D20-C20-L150-Z04-H	●	20	4	20	150	50	1				
AHFM-EP1003-D21-C20-L150-Z04-H	●	21	4	20	150	20	1				

R: Sağ / Right / Правый L: Sol/Left/Левый

● Stokta / In Stock / В наличии ○ Stokta Yok / Non Stock Item / Нет в наличии

DJT Uçuna Uygundur. / Compatiple with DJT Insert. / Под пластину DJT

Sipariş Örneği/Ordering Example/Образец заказа

1 ad./pcs./шт AHFM-BL0603-D16-C15-L150-Z02

Kesme Hesabı : S 321 / Cutting Calculation : P 321 / Расчет режимов резания: стр. 321



www.akkо.com.tr

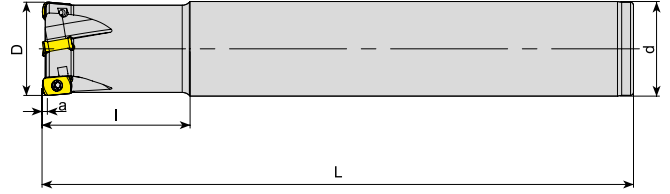

Takım Kodu Ordering Code Код для заказа	Stok Stock Наличие	Takım Ölçüleri (mm) Dimension (mm) Размеры (мм)						Kesici Uç Insert Пластина	Yedek Parçaları / Spare Parts / Запасные части		
		D	Z	d	L	l	a		Sıkma Vidası Screw Зажимной винт	Tork Anahtar Torx Key Торх Ключ	
AHFM-EN1004-D16-C16-L150-Z02	●	16	2	16	150	25	1	ENMU 1004..	3008-M2.5x5	80-T08	
AHFM-EN1004-D17-C16-L150-Z02-H	●	17	2	16	150	25	1				
AHFM-EN1004-D17-C16-L150-Z02	●	17	2	16	150	25	1				
AHFM-EN1004-D17-C16-L200-Z02	●	17	2	16	200	25	1				
AHFM-EN1004-D18-C16-L150-Z02	●	18	2	16	150	25	1				
AHFM-EN1004-D20-C20-L150-Z03	●	20	3	20	150	40	1				
AHFM-EN1004-D21-C20-L150-Z02	●	21	2	20	150	30	1				
AHFM-EN1004-D21-C20-L150-Z03	●	21	3	20	150	30	1				
AHFM-EN1004-D21-C20-L200-Z03	●	21	3	20	200	30	1				
AHFM-EN1004-D22-C20-L150-Z03	●	22	3	20	150	30	1				
AHFM-EN1004-D25-C25-L150-Z03	●	25	3	25	150	40	1				
AHFM-EN1004-D25-C25-L150-Z04	●	25	4	25	150	40	1				
AHFM-EN1004-D26-C25-L150-Z03	●	26	3	25	150	30	1				
AHFM-EN1004-D26-C25-L150-Z04	●	26	4	25	150	30	1				
AHFM-EN1004-D26-C25-L200-Z03	●	26	3	25	150	30	1				
AHFM-EN1004-D26-C25-L200-Z03-H	●	26	3	25	200	30	1				
AHFM-EN1004-D26-C25-L250-Z03-H	●	26	3	25	250	30	1				
AHFM-EN1004-D28-C25-L200-Z04	●	28	4	25	200	30	1				
AHFM-EN1004-D32-C32-L200-Z04	●	32	4	32	200	50	1				
AHFM-EN1004-D33-C32-L200-Z04	●	33	4	32	200	30	1				

DJT Ucuna Uygundur. / Compatible with DJT Insert. / Под пластину DJT

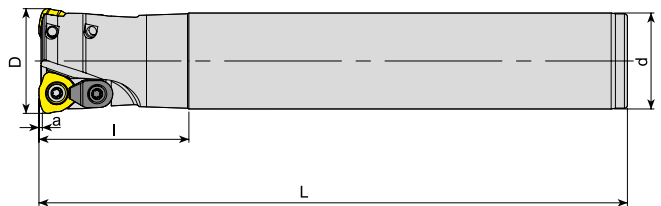

Takım Kodu Ordering Code Код для заказа	Stok Stock Наличие	Takım Ölçüleri (mm) Dimension (mm) Размеры (мм)						Kesici Uç Insert Пластина	Yedek Parçaları / Spare Parts / Запасные части			
		D	Z	d	L	l	a		Sıkma Vidası Screw Зажимной винт	Baskı Parçası Wedge Clamp Прижим	Baskı Vidası Clamp Screw Зажимной винт	Tork Anahtar Torx Key Торх Ключ
AHFMC-JD1204-D32-C32-L150-Z02	●	32	2	32	150	30	1	JDMW 1204..	4615-M4x11	ACK-05	4015-M4x11	80-T15
AHFMC-JD1204-D32-C32-L200-Z02	●	32	2	32	200	30	1					
AHFMC-JD1204-D35-C32-L200-Z02	●	35	2	32	200	30	1					
AHFMC-JD1204-D35-C32-L250-Z02	●	35	2	32	250	30	1					

R: Sağ / Right / Правый L: Sol/Left/Левый

● Stokta / In Stock / В наличии ○ Stokta Yok / Non Stock Item / Нет в наличии

MTSBSH Ucuna Uygundur. / Compatible with MTSBSH Insert. / Под пластину MTSBSH

Sipariş Örneği/Ordering Example/Образец заказа

1 ad./pcs./шт AHFM-EN1004-D16-C16-L150-Z02

Kesme Hesabı : S 321 / Cutting Calculation : P 321 / Расчет режимов резания : стр. 321

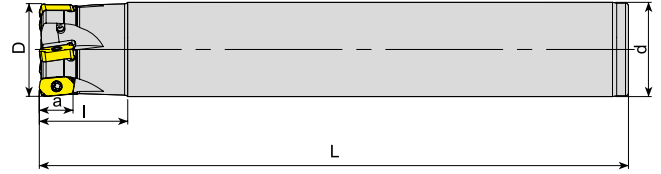

Takım Kodu Ordering Code Код для заказа	Stok Stock Наличие	Takım Ölçüleri (mm) Dimension (mm) Размеры (мм)						Kesici Uç Insert Пластина	Yedek Parçaları / Spare Parts / Запасные части		
		D	Z	d	L	l	a		Sıkma Vidası Screw Зажимной винт	Tork Anahtar Torx Key Торх Ключ	
AHFM-LN120-D16-C15-L150-Z02	●	16	2	15	150	30	12	LNMX 1235..			
AHFM-LN120-D21-C20-L150-Z03	●	21	3	20	150	30	12				
AHFM-LN120-D26-C25-L150-Z04	●	26	4	25	150	30	12				
AHFM-LN120-D33-C32-L200-Z05	●	33	5	32	200	30	12				

B.OKE Ucuna Uygundur. / Compatible with B.OKE Insert. / Под пластину B.OKE

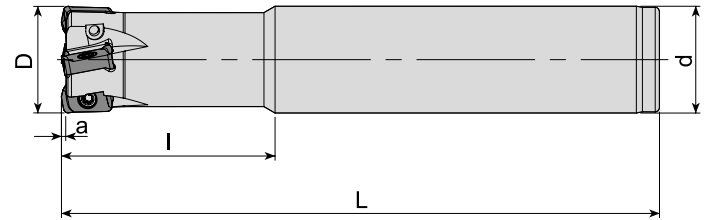

Takım Kodu Ordering Code Код для заказа	Stok Stock Наличие	Takım Ölçüleri (mm) Dimension (mm) Размеры (мм)						Kesici Uç Insert Пластина	Yedek Parçaları / Spare Parts / Запасные части		
		D	Z	d	L	l	a		Sıkma Vidası Screw Зажимной винт	Tork Anahtar Torx Key Торх Ключ	
AHFM-L003-D16-C15-L160-Z02	●	16	2	15	160	30	1	LOGU 0303..			
AHFM-L003-D16-C16-L100-Z02-F	●	16	2	16	100	30	1				
AHFM-L003-D16-C16-L100-Z02	●	16	2	16	100	30	1				
AHFM-L003-D16-C16-L160-Z02	●	16	2	16	160	50	1				
AHFM-L003-D17-C16-L180-Z02	●	17	2	16	180	30	1				
AHFM-L003-D20-C20-L130-Z03	●	20	3	20	130	40	1				
AHFM-L003-D20-C20-L160-Z03	●	20	3	20	160	80	1				
AHFM-L003-D21-C20-L200-Z03	●	21	3	20	200	30	1				
AHFM-L003-D25-C25-L140-Z04-F	●	25	4	25	140	50	1				
AHFM-L003-D25-C25-L140-Z04	●	25	4	25	140	50	1				
AHFM-L003-D25-C25-L180-Z04	●	25	4	25	180	100	1				
AHFM-L003-D32-C32-L200-Z05	●	32	5	32	200	120	1				

R: Sağ / Right / Правый L: Sol/Left/Левый
 ● Stokta / In Stock / В наличии ○ Stokta Yok / Non Stock Item / Нет в наличии
 KYCR Ucuna Uygundur. / Compatible with KYCR Insert. / Под пластину KYCR

Sipariş Örneği/Ordering Example/Образец заказа
 1 ad./pcs./шт AHFM-LN120-D16-C15-L150-Z02
 Kesme Hesabı : S 321 / Cutting Calculation : P 321 / Расчет режимов резания: стр. 321

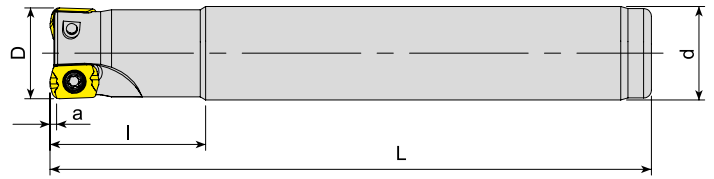

Takım Kodu Ordering Code Код для заказа	Stok Stock Наличие	Takım Ölçüleri (mm) Dimension (mm) Размеры (мм)						Kesici Uç Insert Пластина	Yedek Parçaları / Spare Parts / Запасные части		
		D	Z	d	L	l	a		Sıkma Vidası Screw Зажимной винт	Tork Anahtar Torx Key Торкс Ключ	
AHFM-LP0102-D10-C09-L120-Z02	●	10	2	9	120	20	0.5	LPGT 0102..			
AHFM-LP0102-D10-C10-L120-Z02	●	10	2	10	120	20	0.5				
AHFM-LP0102-D12-C11-L120-Z02	●	12	2	11	120	20	0.5				
AHFM-LP0102-D12-C12-L120-Z02	●	12	2	12	120	20	0.5				

KYCR Ucuna Uygunudur. / Compatible with KYCR Insert. / Под пластину KYCR

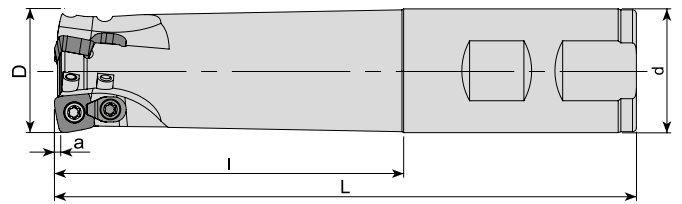

Takım Kodu Ordering Code Код для заказа	Stok Stock Наличие	Takım Ölçüleri (mm) Dimension (mm) Размеры (мм)						Kesici Uç Insert Пластина	Yedek Parçaları / Spare Parts / Запасные части			
		D	Z	d	L	l	a		Sıkma Vidası Screw Зажимной винт	Baskı Parçası Wedge Clamp Прижим	Baskı Vidası Clamp Screw Зажимной винт	Tork Anahtar Torx Key Торкс Ключ
AHFM-SD06T2-D16-C16-L150-Z02-H	●	16	2	16	150	50	0.8	SD.. 06T2..				
AHFM-SD06T2-D17-C16-L150-Z02-H	●	17	2	16	150	50	0.8					
AHFM-SD06T2-D20-C20-L150-Z03-H	●	20	3	20	150	50	0.8					
AHFM-SD06T2-D21-C20-L150-Z03-H	●	21	3	20	150	50	0.8					
AHFM-SD06T2-D25-C25-L150-Z04-H	●	25	4	25	150	50	0.8					
AHFM-SD06T2-D26-C25-L150-Z04-H	●	26	4	25	150	60	0.8					
AHFMC-SD09T3-D25-C25-L150-Z02	●	25	2	25	150	100	1.4	SD.. 09T3..				
AHFMC-SD09T3-D25-W25-L150-Z02	●	25	2	25	150	100	1.4					
AHFMC-SD09T3-D32-C32-L150-Z03	●	32	3	32	150	100	1.4					
AHFMC-SD09T3-D32-W32-L150-Z03	●	32	3	32	150	100	1.4					

R: Sağ / Right / Правый L: Sol/Left/Левый

● Stokta / In Stock / В наличии ○ Stokta Yok / Non Stock Item / Нет в наличии

ZCC Ucuna Uygunudur. / Compatible with ZCC Insert. / Под пластину ZCC

Sipariş Örneği/Ordering Example/Образец заказа

1 ad./pcs./шт AHFM-LP0102-D10-C09-L120-Z02

Kesme Hesabı : S 321 / Cutting Calculation : P 321 / Расчет режимов резания: стр. 321

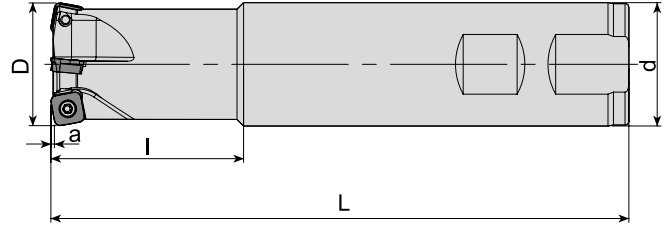

Takım Kodu Ordering Code Код для заказа	Stok Stock Наличие	Takım Ölçüleri (mm) Dimension (mm) Размеры (мм)						Kesici Uç Insert Пластина	Yedek Parçaları / Spare Parts / Запасные части		
		D	Z	d	L	l	a		Sıkma Vidası Screw Зажимной винт	Tork Anahtar Torx Key Торх Ключ	
AHFM-SO0803-D20-W20-L150-Z02	●	20	2	20	150	50	-				
AHFM-SO0803-D25-W25-L150-Z03	●	25	3	25	150	50	-				
AHFM-SO0803-D32-W32-L150-Z04	●	32	4	32	150	50	-				

KPTK Ucuna Uygunudur. / Compatiple with KPTK Insert. / Под пластину KPTK

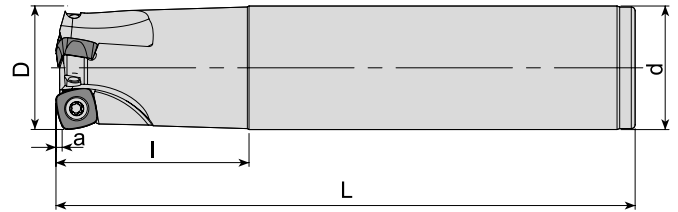

Takım Kodu Ordering Code Код для заказа	Stok Stock Наличие	Takım Ölçüleri (mm) Dimension (mm) Размеры (мм)						Kesici Uç Insert Пластина	Yedek Parçaları / Spare Parts / Запасные части		
		D	Z	d	L	l	a		Sıkma Vidası Screw Зажимной винт	Tork Anahtar Torx Key Торх Ключ	
AHFM-SP1004-D25-C25-L150-Z02	●	25	2	25	150	50	1.5				
AHFM-SP1004-D32-C32-L150-Z03	●	32	3	32	150	50	1.5				

R: Sağ / Right / Правый L: Sol/Left/Левый
 ● Stokta / In Stock / В наличии ○ Stokta Yok / Non Stock Item / Нет в наличии
 DJT Ucuna Uygunudur. / Compatiple with DJT Insert. / Под пластину DJT

Sipariş Örneği/Ordering Example/Образец заказа
 1 ad./pcs./шт AHFM-SO0803-D20-W20-L150-Z02
 Kesme Hesabı : S 321 / Cutting Calculation : P 321 / Расчет режимов резания: стр. 321

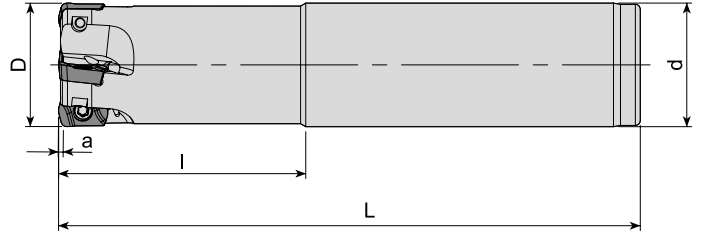

Takım Kodu Ordering Code Код для заказа	Stok Stock Наличие	Takım Ölçüleri (mm) Dimension (mm) Размеры (мм)						Kesici Uç Insert Пластина	Yedek Parçaları / Spare Parts / Запасные части		
		D	Z	d	L	l	a		Sıkma Vidası Screw Зажимной винт	Tork Anahtar Torx Key Торх Ключ	
AHFM-YP1003-D16-C15-L150-Z02-F	●	16	2	15	150	20	1	YPHW 1003..	3008-M2.5x5	80-T08	
AHFM-YP1003-D16-C15-L200-Z02-F	●	16	2	15	200	20	1				
AHFM-YP1003-D16-C16-L150-Z02-F	●	16	2	16	150	50	1				
AHFM-YP1003-D17-C16-L150-Z02-F	●	17	2	16	150	20	1				
AHFM-YP1003-D17-C16-L200-Z02-F	●	17	2	16	200	20	1				
AHFM-YP1003-D20-C18-L150-Z03-F	●	20	3	18	150	25	1				
AHFM-YP1003-D20-C18-L200-Z03-F	●	20	3	18	200	25	1				
AHFM-YP1003-D20-C20-L150-Z03-F	●	20	3	20	150	50	1				
AHFM-YP1003-D21-C20-L150-Z03-F	●	21	3	20	150	20	1				
AHFM-YP1003-D21-C20-L150-Z04-F	●	21	4	20	150	20	1				
AHFM-YP1003-D21-C20-L200-Z03-F	●	21	3	20	200	20	1				
AHFM-YP1003-D25-C20-L150-Z04-F	●	25	4	20	150	25	1				
AHFM-YP1003-D25-C20-L200-Z04-F	●	25	4	20	200	25	1				
AHFM-YP1003-D25-C25-L150-Z04-F	●	25	4	25	150	50	1				
AHFM-YP1003-D26-C25-L150-Z04-F	●	26	4	25	150	30	1				
AHFM-YP1003-D26-C25-L200-Z03-F	●	26	3	25	200	30	1				
AHFM-YP1003-D26-C25-L200-Z04-F	●	26	4	25	200	30	1				

R: Sağ / Right / Правый L: Sol/Left/Левый

● Stokta / In Stock / В наличии ○ Stokta Yok / Non Stock Item / Нет в наличии
DJT Ucuna Uygun. / Compatible with DJT Insert. / Под пластину DJT

Sipariş Örneği/Ordering Example/Образец заказа

1 ad./pcs./шт AHFM-YP1003-D16-C15-L150-Z02-F

Kesme Hesabı : S 321 / Cutting Calculation : P 321 / Расчет режимов резания: стр. 321



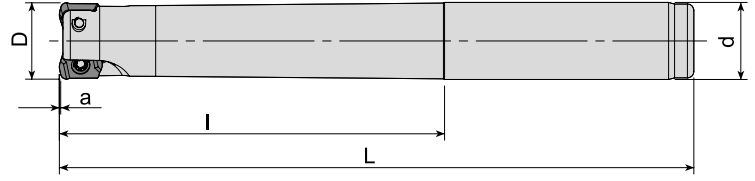

Takım Kodu Ordering Code Код для заказа	Stok Stock Наличие	Takım Ölçüleri (mm) Dimension (mm) Размеры (мм)						Kesici Uç Insert Пластина	Yedek Parçaları / Spare Parts / Запасные части		
		D	Z	d	L	l	a		Sıkma Vidası Screw Зажимной винт	Tork Anahtar Torx Key Торх Ключ	
AHFM-Y00602-D10-C09-L120-Z02-F	●	10	2	9	120	15	0.3	Y0HW 0602..	3006-M1.8X4	80-T06	
AHFM-Y00602-D10-C10-L080-Z02-F	●	10	2	10	80	20	0.3				
AHFM-Y00602-D10-C10-L120-Z02-F	●	10	2	10	120	60	0.3				
AHFM-Y00602-D10-C10-L120-Z02-H-F	●	10	2	10	120	60	0.3				
AHFM-Y00602-D10-C10-L120-Z02-H	●	10	2	10	120	60	0.3				
AHFM-Y00602-D12-C11-L120-Z02-F	●	12	2	11	120	15	0.3				
AHFM-Y00602-D12-C11-L120-Z02-H-F	●	12	2	11	120	15	0.3				
AHFM-Y00602-D12-C11-L120-Z02-H	●	12	2	11	120	15	0.3				
AHFM-Y00602-D12-C11-L120-Z03-F	●	12	3	11	120	15	0.3				
AHFM-Y00602-D12-C12-L080-Z02-F	●	12	2	12	80	20	0.3				
AHFM-Y00602-D12-C12-L080-Z03-F	●	12	3	12	80	20	0.3				
AHFM-Y00602-D12-C12-L120-Z02-F	●	12	2	12	120	60	0.3				
AHFM-Y00602-D12-C12-L120-Z03-F	●	12	3	12	120	60	0.3				

DJT Ucuna Uygunur. / Compatible with DJT Insert. / Под пластину DJT

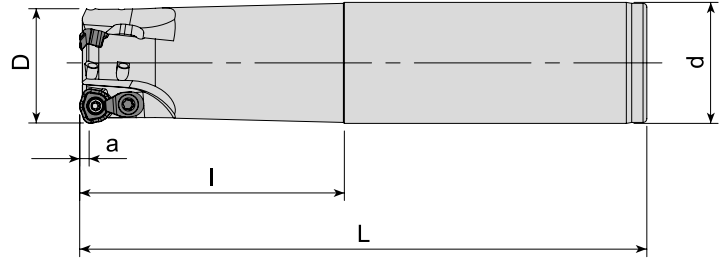

Takım Kodu Ordering Code Код для заказа	Stok Stock Наличие	Takım Ölçüleri (mm) Dimension (mm) Размеры (мм)						Kesici Uç Insert Пластина	Yedek Parçaları / Spare Parts / Запасные части			
		D	Z	d	L	l	a		Sıkma Vidası Screw Зажимной винт	Baskı Parçası Wedge Clamp Прижим	Baskı Vidası Clamp Screw Зажимной винт	Tork Anahtar Torx Key Торх Ключ
AHFM-WD0603-D16-C16-L150-Z02	●	16	2	16	150	70	2	WDMT 0603..	3008-M2.5x6	-	-	80-T08
AHFM-WD0603-D20-C20-L150-Z03	●	20	3	20	150	70	2					
AHFMC-WD0804-D25-C25-L150-Z02	●	25	2	25	150	70	2.5	WDMT 0804..	4010-M3x8	ACK-15	4010-M3x8	80-T10
AHFMC-WD0804-D32-C32-L150-Z03	●	32	3	32	150	70	2.5					
AHFMC-WD1205-D32-C32-L150-Z02	●	32	2	32	150	70	3	WDMT 1205..	1415-M4x11	ACK-05	4015-M4x11	80-T15

R: Sağ / Right / Правый L: Sol/Left/Левый

● Stokta / In Stock / В наличии ○ Stokta Yok / Non Stock Item / Нет в наличии

SMTM Ucuna Uygunur. / Compatible with SMTM Insert. / Под пластину SMTM

Sipariş Örneği/Ordering Example/Образец заказа

1 ad./pcs./шт AHFM-Y00602-D10-C09-L120-Z02-F

Kesme Hesabı : S 321 / Cutting Calculation : P 321 / Расчет режимов резания: стр. 321

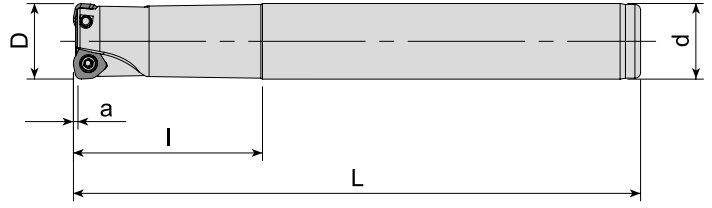

Takım Kodu Ordering Code Код для заказа	Stok Stock Наличие	Takım Ölçüleri (mm) Dimension (mm) Размеры (мм)						Kesici Uç Insert Пластина	Yedek Parçaları / Spare Parts / Запасные части			
		D	Z	d	L	l	a		Sıkma Vidası Screw Зажимной винт	Baskı Parçası Wedge Clamp Прижим	Baskı Vidası Clamp Screw Зажимной винт	Tork Anahtar Torx Key Торх Ключ
AHFM-WD0503D-D20-C20-L150-Z02	●	20	2	20	150	50	1.25	WD.W 0503..	4010-M3x6	-	-	80-T10
AHFM-WD0503D-D21-C20-L150-Z02	●	21	2	20	150	30	1.25					
AHFMC-WD06T3D-D26-C25-L200-Z02	●	26	2	25	200	30	1.5	WD.W 06T3..	3015-M3.5x9	ACK-15	4015-M3.5x11	80-T15
AHFMC-WD06T3D-D33-C32-L200-Z03	●	33	3	32	200	32	1.5					

DJT Ucuna Uygundur. / Compatible with DJT Insert. / Под пластину DJT

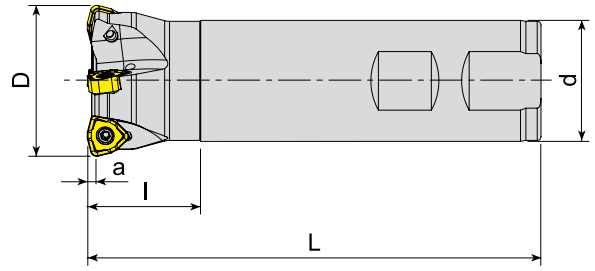

Takım Kodu Ordering Code Код для заказа	Stok Stock Наличие	Takım Ölçüleri (mm) Dimension (mm) Размеры (мм)						Kesici Uç Insert Пластина	Yedek Parçaları / Spare Parts / Запасные части	
		D	Z	d	L	l	a		Sıkma Vidası Screw Зажимной винт	Tork Anahtar Torx Key Торх Ключ
AHFM-WN0603-D16-C16-L110-Z02-H	●	16	2	16	110	30	1	WNMX 0603..	3008-M2.5x6	80-T08
AHFM-WN0603-D16-C16-L150-Z02-H	●	16	2	16	150	70	1			
AHFM-WN0603-D17-C16-L150-Z02-H	●	17	2	16	150	20	1			
AHFM-WN0603-D20-C20-L150-Z02-H	●	20	2	20	150	70	1			
AHFM-WN0603-D20-C20-L200-Z02-H	●	20	2	20	200	100	1			
AHFM-WN0603-D21-C20-L150-Z02-H	●	21	2	20	150	20	1			
AHFM-WN09T3-D25-W25-L120-Z02-H	●	25	2	25	120	40	1.5	WNMX 09T3..	4010-M3x8	80-T10
AHFML-WN09T3-D25-W25-L120-Z02-H	●	25	2	25	120	40	1.5			
AHFM-WN09T3-D25-C25-L200-Z02	●	25	2	25	200	120	1.5			
AHFM-WN09T3-D32-W32-L120-Z03-H	●	32	3	32	120	30	1.5			
AHFM-WN09T3-D32-W32-L200-Z03-H	○	32	3	32	200	100	1.5			
AHFM-WN09T3-D35-W32-L200-Z04-H	●	35	4	32	200	50	1.5			
AHFM-WN09T3-D40-W32-L120-Z04-H	●	40	4	32	120	30	1.5	WNMX 1305..	4015-M4x11	80-T15
AHFM-WN09T3-D40-C32-L200-Z04	●	40	4	32	200	30	1.5			
AHFM-WN1305-D32-C32-L150-Z02-H	○	32	2	32	150	70	2			
AHFM-WN1305-D32-C32-L200-Z02-H	●	32	2	32	200	30	2			

R: Sağ / Right / Правый L: Sol/Left/Левый
● Stokta / In Stock / В наличии ○ Stokta Yok / Non Stock Item / Нет в наличии
KRLY Ucuna Uygundur. / Compatible with KRLY Insert. / Под пластину KRLY

Sipariş Örneği/Ordering Example/Образец заказа
1 ad./pcs./шт AHFM-WD0503D-D20-C20-L150-Z02
Kesme Hesabı : S 321 / Cutting Calculation : P 321 / Расчет режимов резания: стр. 321

➤ **S-SİSTEM HIZLI İLERLEMELİ PARMAK FREZELER**
S-SYSTEM HIGHFEED END MILLS
С-ТИП ВЫСОКОПРОИЗВОДИТЕЛЬНЫЕ КОНЦЕВЫЕ ФРЕЗЫ

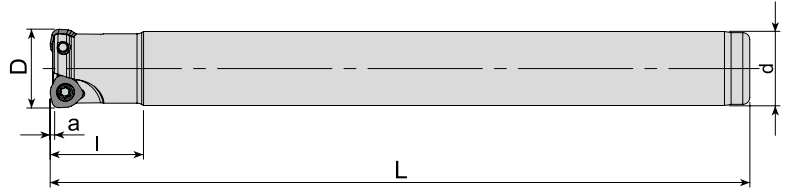

Takım Kodu Ordering Code Код для заказа	Stok Stock Наличие	Takım Ölçüleri (mm) Dimension (mm) Размеры (мм)						Kesici Uç Insert Пластина	Yedek Parçaları / Spare Parts / Запасные части		
		D	Z	d	L	l	a		Sıkma Vidası Screw Зажимной винт	Tork Anahtar Torx Key Торх Ключ	
AHFM-W004T2D-D16-C16-L150-Z02	●	16	2	16	150	20	0.8	WOMW 04T2..		3008-M2.5x6	
AHFM-W004T2D-D17-C16-L150-Z02	●	17	2	16	150	20	0.8				

DJT Ucuna Uygun. / Compatible with DJT Insert. / Под пластину DJT

➤ **S-SİSTEM MODÜLER PARMAK FREZELER**
S-SYSTEM MODULAR END MILLS (SCREW TYPE TOOLS)
С-ТИП СМЕННЫЕ ФРЕЗЕРНЫЕ ГОЛОВКИ (КРЕПЛЕНИЕ ПОД РЕЗЬБУ)

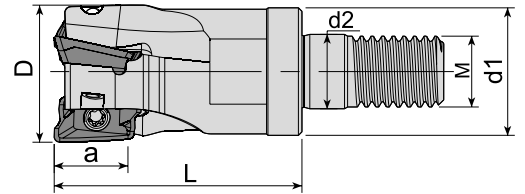

Takım Kodu Ordering Code Код для заказа	Stok Stock Наличие	Takım Ölçüleri (mm) Dimension (mm) Размеры (мм)							Kesici Uç Insert Пластина	Yedek Parçaları / Spare Parts / Запасные части		
		D	Z	d1	M	L	d2	a		Sıkma Vidası Screw Зажимной винт	Tork Anahtar Torx Key Торх Ключ	
AEM90-A01236-D16-M08-L30-Z02	●	16	2	14.8	M08	30	8.5	12	AO.. 1236..			
AEM90-A01236-D20-M10-L35-Z03	●	20	3	18	M10	35	10.5	12				

R: Sağ / Right / Правый L: Sol/Left/Левый

● Stokta / In Stock / В наличии ○ Stokta Yok / Non Stock Item / Нет в наличии

MTSBH Ucuna Uygun. / Compatible with MTSBH Insert. / Под пластину MTSBH

Sipariş Örneği/Ordering Example/Образец заказа

1 ad./pcs./шт AHFM-W004T2D-D16-C16-L150-Z02

Kesme Hesabı : S 321 / Cutting Calculation : P 321 / Расчет режимов резания: стр. 321

Sıkma Tork Değeri : S 320 / Tightening Torque : P 320 / Момент затяжки: стр. 320



www.akkо.com.tr

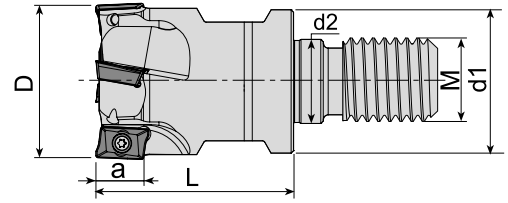

Takım Kodu Ordering Code Код для заказа	Stok Stock Наличие	Takım Ölçüleri (mm) Dimension (mm) Размеры (мм)							Kesici Uç Insert Пластина	Yedek Parçaları / Spare Parts / Залпасные части		
		D	Z	d1	M	L	d2	a		Sıkma Vidası Screw Зажимной винт	Tork Anahtar Torx Key Торх Ключ	
AEM90-AD1505D-D25-M12-L43-Z02-H	●	25	2	21	M12	43	12.5	14.3	ADKT 150508	4015-M4x9 4015-M4x11	80-T15	
AEM90-AD1505D-D32-M16-L43-Z03-H	●	32	3	29	M16	43	17	14.3				

DJT Ucuna Uygun. / Compatiple with DJT Insert. / Под пластину DJT

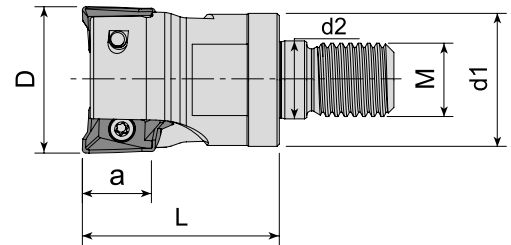

Takım Kodu Ordering Code Код для заказа	Stok Stock Наличие	Takım Ölçüleri (mm) Dimension (mm) Размеры (мм)							Kesici Uç Insert Пластина	Yedek Parçaları / Spare Parts / Залпасные части		
		D	Z	d1	M	L	d2	a		Sıkma Vidası Screw Зажимной винт	Tork Anahtar Torx Key Торх Ключ	
AEM90-AX1235-D16-M08-L30-Z02-H	●	16	2	14.75	M08	30	8.5	10	AX.T 1235..	3008-M3x6	80-T08	
AEM90-AX1235-D20-M10-L30-Z03-H	●	20	3	18	M10	30	10.5	10				
AEM90-AX1235-D25-M12-L35-Z04-H	●	25	4	21	M12	35	12.5	10	AX.T 1705..	4015-M4x9	80-T15	
AEM90-AX1705-D25-M12-L43-Z02-H	●	25	2	21	M12	43	12.5	14				
AEM90-AX1705-D32-M16-L43-Z02-H	●	32	2	29	M16	43	17	14				

R: Sağ / Right / Правый L: Sol/Left/Левый
● Stokta / In Stock / В наличии ○ Stokta Yok / Non Stock Item / Нет в наличии
SMTM Ucuna Uygun. / Compatiple with SMTM Insert. / Под пластину SMTM

Sipariş Örneği/Ordering Example/Образец заказа
1 ad./pcs./шт AEM90-AD1505D-D25-M12-L43-Z02-H
Kesme Hesabı : S 321 / Cutting Calculation : P 321 / Расчет режимов резания: стр. 321
Sıkma Tork Değeri : S 320 / Tightening Torque : P 320 / Момент затяжки: стр. 320

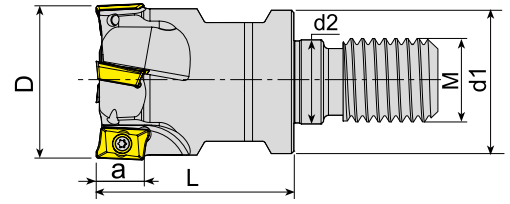

Takım Kodu Ordering Code Код для заказа	Stok Stock Наличие	Takım Ölçüleri (mm) Dimension (mm) Размеры (мм)							Kesici Uç Insert Пластина	Yedek Parçaları / Spare Parts / Залпасные части	
		D	Z	d1	M	L	d2	a		Sıkma Vidası Screw Зажимной винт	Tork Anahtar Torx Key Торх Ключ
AEM90-AP10-D16-M08-L30-Z02-H	●	16	2	14.75	M08	30	8.5	10	AP.. 1003.. ISO UCUNA UYGUNDUR. FOR ISO INSERT. Под пластину ISO	3008-M2.5x6	80-T08
AEM90-AP10-D20-M10-L30-Z03-H	●	20	3	18	M10	30	10.5	10			
AEM90-AP10-D25-M12-L35-Z03-H	●	25	3	21	M12	35	12.5	10			
AEM90-AP10-D32-M16-L35-Z04-H	●	32	4	29	M16	35	17	10			
AEM90-AP10-D40-M16-L43-Z05-H	●	40	5	29	M16	43	17	10			
AEM90-AP10-D42-M16-L43-Z05-H	●	42	5	29	M16	43	17	10			
AEM90-AP10D-D16-M08-L30-Z02-H	●	16	2	14.75	M08	30	8.5	10	AP.. 1003.. DJT UCUNA UYGUNDUR. FOR DJT INSERT. Под пластину DJT	3008-M2.5x6	80-T08
AEM90-AP10D-D20-M10-L30-Z03-H	●	20	3	18	M10	30	10.5	10			
AEM90-AP10D-D25-M12-L35-Z03-H	●	25	3	21	M12	35	12.5	10			
AEM90-AP11-D16-M08-L30-Z02-H	●	16	2	14.75	M08	30	8.5	11	AP.. 11T3.. ZCC UCUNA UYGUNDUR. FOR ZCC INSERT. Под пластину ZCC	4015-M4x9	80-T15
AEM90-AP11-D20-M10-L30-Z03-H	●	20	3	18	M10	30	10.5	11			
AEM90-AP11-D25-M12-L35-Z03-H	●	25	3	21	M12	35	12.5	11			
AEM90-AP11-D32-M16-L35-Z04-H	●	32	4	29	M16	35	17	11			
AEM90-AP11-D40-M16-L43-Z05-H	●	40	5	29	M16	43	17	11	AP.. 1604.. ISO UCUNA UYGUNDUR. FOR ISO INSERT. Под пластину ISO	4015-M4x9	80-T15
AEM90-AP16-D25-M12-L43-Z02-H	●	25	2	21	M12	43	12.5	16			
AEM90-AP16-D32-M16-L43-Z03-H	●	32	3	29	M16	43	17	16			
AEM90-AP16-D40-M16-L43-Z04-H	●	40	4	29	M16	43	17	16			
AEM90-AP16-D42-M16-L43-Z04-H	●	42	4	29	M16	43	17	16			
AEM90-AP16D-D25-M12-L43-Z02-H	●	25	2	21	M12	43	12.5	16			
AEM90-AP16D-D32-M16-L43-Z03-H	●	32	3	29	M16	43	17	16	AP.. 1604.. DJT UCUNA UYGUNDUR. FOR DJT INSERT. Под пластину DJT	4015-M4x9	80-T15
AEM90-AP16D-D40-M16-L43-Z04-H	●	40	4	29	M16	43	17	16			
AEM90-AP16D-D42-M16-L43-Z04-H	●	42	4	29	M16	43	17	16			
AEM90-AP16L-D25-M12-L43-Z02-H	●	25	2	21	M12	43	12.5	16	AP.. 1604.. LMN UCUNA UYGUNDUR. FOR LMN INSERT. Под пластину LMN	4015-M4x9	80-T15
AEM90-AP16L-D32-M16-L43-Z03-H	●	32	3	29	M16	43	17	16			
AEM90-AP16L-D40-M16-L43-Z04-H	●	40	4	29	M16	43	17	16			

R: Sağ / Right / Правый L: Sol/Left/Левый
● Stokta / In Stock / В наличии ○ Stokta Yok / Non Stock Item / Нет в наличии

Sipariş Örneği/Ordering Example/Образец заказа
1 ad./pcs./шт AEM90-AP10-D16-M08-L30-Z02-H

Kesme Hesabı : S 321 / Cutting Calculation : P 321 / Расчет режимов резания: стр. 321
Sıkma Tork Değeri : S 320 / Tightening Torque : P 320 / Момент затяжки: стр. 320

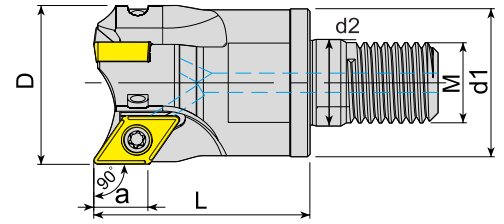

Takım Kodu Ordering Code Код для заказа	Stok Stock Наличие	Takım Ölçüleri (mm) Dimension (mm) Размеры (мм)							Kesici Uç Insert Пластина	Yedek Parçaları / Spare Parts / Запасные части		
		D	Z	d1	M	L	d2	a		Sıkma Vidası Screw Зажимной винт	Tork Anahtar Torx Key Торх Ключ	
AEM90-DC07-D20-M10-L30-Z02-H	●	20	2	18	M10	30	10.5	7	DC.T 0702.			
AEM90-DC07-D25-M12-L35-Z03-H	●	25	3	21	M12	35	12.5	7				
AEM90-DC07-D32-M16-L43-Z04-H	●	32	4	29	M16	43	17	7				
AEM90-DC07-D40-M16-L43-Z05-H	●	40	5	29	M16	43	17	7				
AEM90-DC11-D32-M16-L43-Z03-H-F	●	32	3	29	M16	43	17	11	DC.T 11T3..			
AEM90-DC11-D40-M16-L43-Z03-H-F	●	40	3	29	M16	43	17	11				

F: Çap toleransı +, - 0.02 mm içerisinde anlamına gelmektedir. / F: Diameter tolerance is between +, - 0.02 mm. / F: Допуск на диаметр +, - 0.02 мм.
ISO Ucuna Uygundur. / Compatible with ISO Insert. / Под пластину ISO

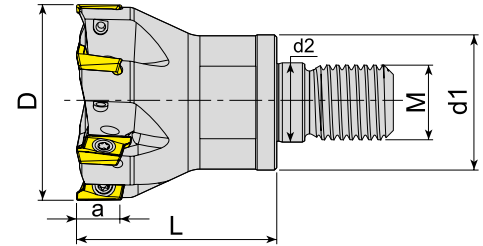

Takım Kodu Ordering Code Код для заказа	Stok Stock Наличие	Takım Ölçüleri (mm) Dimension (mm) Размеры (мм)							Kesici Uç Insert Пластина	Yedek Parçaları / Spare Parts / Запасные части		
		D	Z	d1	M	L	d2	a		Sıkma Vidası Screw Зажимной винт	Tork Anahtar Torx Key Торх Ключ	
AEM90-RT10-D16-M08-L20-Z02-H	●	16	2	14.75	M08	20	8.5	10	RT 1003..			
AEM90-RT10-D20-M10-L25-Z03-H	●	20	3	18	M10	25	10.5	10				
AEM90-RT10-D25-M12-L30-Z04-H	●	25	4	21	M12	30	12.5	10				
AEM90-RT10-D32-M16-L43-Z05-H	●	32	5	29	M16	43	17	10				
AEM90-RT10-D42-M16-L43-Z06-H	●	42	6	29	M16	43	17	10				

R: Sağ / Right / Правый L: Sol/Left/Левый
● Stokta / In Stock / В наличии ○ Stokta Yok / Non Stock Item / Нет в наличии
SFTY Ucuna Uygundur. / Compatible with SFTY Insert. / Под пластину SFTY

Sipariş Örneği/Ordering Example/Образец заказа
1 ad./pcs./шт AEM90-DC07-D20-M10-L30-Z02-H
Kesme Hesabı : S 321 / Cutting Calculation : P 321 / Расчет режимов резания: стр. 321
Sıkma Tork Değeri : S 320 / Tightening Torque : P 320 / Момент затяжки: стр. 320

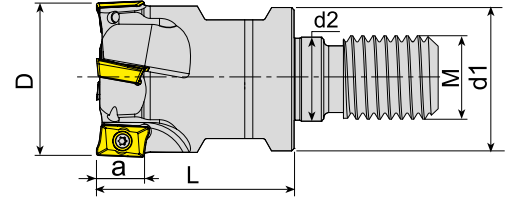

Takım Kodu Ordering Code Код для заказа	Stok Stock Наличие	Takım Ölçüleri (mm) Dimension (mm) Размеры (мм)							Kesici Uç Insert Пластина	Yedek Parçaları / Spare Parts / Запасные части		
		D	Z	d1	M	L	d2	a		Sıkma Vidası Screw Зажимной винт	Tork Anahtar Torx Key Торх Ключ	
AEM90-R390.11-D16-M08-L30-Z02-H	●	16	2	14.75	M08	30	8.5	10	R390-11T3..		80-T08	
AEM90-R390.11-D20-M10-L30-Z03-H	●	20	3	18	M10	30	10.5	10				
AEM90-R390.11-D25-M12-L35-Z03-H	●	25	3	21	M12	35	12.5	10				
AEM90-R390.11-D32-M16-L43-Z04-H	●	32	4	29	M16	43	17	10				

SNDVK Uçuna Uygundur. / Compatiple with SNDVK Insert. / Под пластину SNDVK

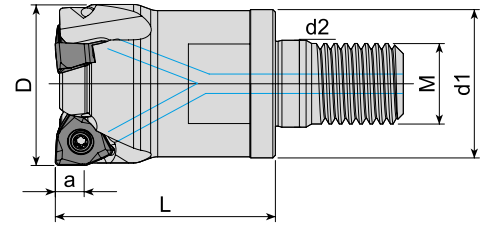

Takım Kodu Ordering Code Код для заказа	Stok Stock Наличие	Takım Ölçüleri (mm) Dimension (mm) Размеры (мм)							Kesici Uç Insert Пластина	Yedek Parçaları / Spare Parts / Запасные части		
		D	Z	d1	M	L	d2	a		Sıkma Vidası Screw Зажимной винт	Tork Anahtar Torx Key Торх Ключ	
AEM90-WN0604Z-D25-M12-L35-Z02-H	●	25	2	21	M12	35	12.5	5.7	WNHU 0604..		80-T08	
AEM90-WN0604Z-D32-M16-L43-Z03-H	●	32	3	29	M16	43	17	5.7				
AEM90-WN0604Z-D40-M16-L43-Z04-H	●	40	4	29	M16	43	17	5.7				

R: Sağ / Right / Правый L: Sol/Left/Левый
● Stokta / In Stock / В наличии ○ Stokta Yok / Non Stock Item / Нет в наличии
ZCC Uçuna Uygundur. / Compatiple with ZCC Insert. / Под пластину ZCC

Sipariş Örneği/Ordering Example/Образец заказа
1 ad./pcs./шт AEM90-R390.11-D16-M08-L30-Z02-H

Kesme Hesabı : S 321 / Cutting Calculation : P 321 / Расчет режимов резания: стр. 321
Sıkma Tork Değeri : S 320 / Tightening Torque : P 320 / Момент затяжки: стр. 320

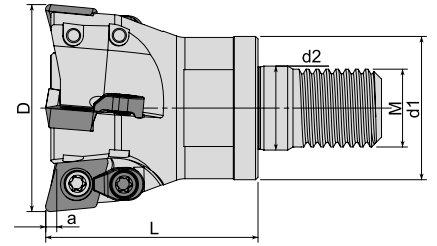

Takım Kodu Ordering Code Код для заказа	Stok Stock Наличие	Takım Ölçüleri (mm) Dimension (mm) Размеры (мм)							Kesici Uç Insert Пластина	Yedek Parçaları / Spare Parts / Запасные части				
		D	Z	d1	M	L	d2	a		Sıkma Vidası Screw Зажимной винт	Baskı Parçası Wedge Clamp Прижим	Baskı Vidası Clamp Screw Зажимной винт	Tork Anahtar Torx Key Торх Ключ	
AEM95-XD0206-D16-M08-L23-Z02-H	●	16	2	14.75	M08	23	8.5	1	XDHW 0206..					
AEM95-XD0206-D16-M08-L23-Z02-H-F	●	16	2	14.75	M08	23	8.5	1						
AEM95-XD0206-D20-M10-L30-Z03-H	●	20	3	18	M10	30	10.5	1						
AEM95-XD0206-D20-M10-L30-Z03-H-F	●	20	3	18	M10	30	10.5	1						
AEM95-XD0206-D25-M12-L35-Z03-H	●	25	3	21	M12	35	12.5	1						
AEM95-XD0206-D25-M12-L35-Z03-H-F	●	25	3	21	M12	35	12.5	1						
AEM95C-XD0310-D35-M16-L43-Z03-H	●	35	3	29	M16	43	17	1.5	XDHW 0310..					
AEM95C-XD0310-D35-M16-L43-Z03-H-F	●	35	3	29	M16	43	17	1.5						
AEM95C-XD0310-D42-M16-L43-Z04-H	●	42	4	29	M16	43	17	1.5						
AEM95C-XD0310-D42-M16-L43-Z04-H-F	●	42	4	29	M16	43	17	1.5						

F: Çap toleransı +, - 0.02 mm içerisinde anlamına gelmektedir. / F: Diameter tolerance is between +, - 0.02 mm. / F: Допуск на диаметр +, - 0.02 mm.
DJT Ucuna Uygundur. / Compatiple with DJT Insert. / Под пластину DJT

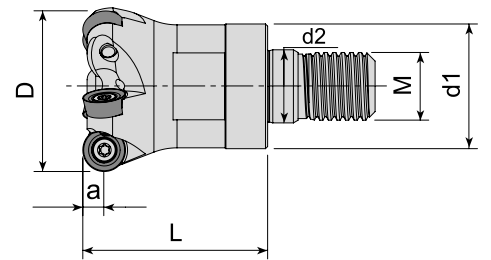

Takım Kodu Ordering Code Код для заказа	Stok Stock Наличие	Takım Ölçüleri (mm) Dimension (mm) Размеры (мм)							Kesici Uç Insert Пластина	Yedek Parçaları / Spare Parts / Запасные части		
		D	Z	d1	M	L	d2	a		Sıkma Vidası Screw Зажимной винт	Tork Anahtar Torx Key Торх Ключ	
AEMR-RC10T3-D25-M12-L35-Z03-H	●	25	3	21	M12	35	12.5	5	RC.. 10T3..			
AEMR-RC10T3-D32-M16-L43-Z04-H	●	32	4	29	M16	43	17	5				
AEMR-RC10T3-D40-M16-L43-Z05-H	●	40	5	29	M16	43	17	5				

R: Sağ / Right / Правый L: Sol/Left/Левый
● Stokta / In Stock / В наличии ○ Stokta Yok / Non Stock Item / Нет в наличии
ZCC Ucuna Uygundur. / Compatiple with ZCC Insert. / Под пластину ZCC

Sipariş Örneği/Ordering Example/Образец заказа
1 ad./pcs./шт AEM95-XD0206-D16-M08-L23-Z02-H
Kesme Hesabı : S 321 / Cutting Calculation : P 321 / Расчет режимов резания: стр. 321
Sıkma Tork Değeri : S 320 / Tightening Torque : P 320 / Момент затяжки: стр. 320

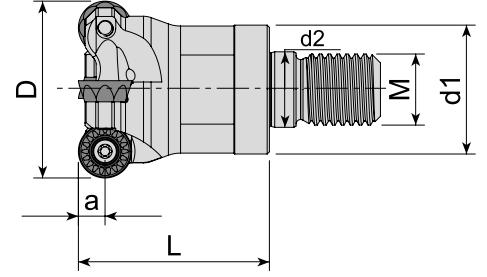

Takım Kodu Ordering Code Код для заказа	Stok Stock Наличие	Takım Ölçüleri (mm) Dimension (mm) Размеры (мм)							Kesici Uç Insert Пластина	Yedek Parçaları / Spare Parts / Запасные части		
		D	Z	d1	M	L	d2	a		Sıkma Vidası Screw Зажимной винт	Tork Anahtar Torx Key Торх Ключ	
AEMR-RP08T2M-D20-M10-L30-Z02-H	●	20	2	18	M10	30	10.5	4				
AEMR-RP10T3M-D25-M12-L35-Z02-H	●	25	2	21	M12	35	12.5	5				
AEMR-RP10T3M-D32-M16-L43-Z03-H	●	32	3	29	M16	43	17	5				
AEMR-RP1204M-D32-M16-L43-Z03-H	●	32	3	29	M16	43	17	6				
AEMR-RP1204M-D40-M16-L43-Z04-H	●	40	4	29	M16	43	17	6				

MTSBSH Ucuna Uygundur. / Compatible with MTSBSH Insert. / Под пластину MTSBSH

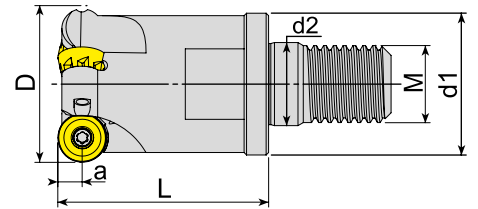

Takım Kodu Ordering Code Код для заказа	Stok Stock Наличие	Takım Ölçüleri (mm) Dimension (mm) Размеры (мм)							Kesici Uç Insert Пластина	Yedek Parçaları / Spare Parts / Запасные части		
		D	Z	d1	M	L	d2	a		Sıkma Vidası Screw Зажимной винт	Tork Anahtar Torx Key Торх Ключ	
AEMR-RP10T3-D25-M12-L35-Z02-H	●	25	2	21	12	35	12.5	5				
AEMR-RP10T3-D32-M16-L43-Z03-H	●	32	3	29	16	43	17	5				
AEMR-RP1204-D32-M16-L43-Z03-H	●	32	3	29	16	43	17	6				

R: Sağ / Right / Правый L: Sol/Left/Левый

● Stokta / In Stock / В наличии ○ Stokta Yok / Non Stock Item / Нет в наличии

CRTZT Ucuna Uygundur. / Compatible with CRTZT Insert. / Под пластину CRTZT



www.akkо.com.tr

Sipariş Örneği/Ordering Example/Образец заказа

1 ad./pcs./шт AEMR-RP08T2M-D20-M10-L30-Z02-H

Kesme Hesabı : S 321 / Cutting Calculation : P 321 / Расчет режимов резания: стр. 321

Sıkma Tork Değeri : S 320 / Tightening Torque : P 320 / Момент затяжки: стр. 320

new

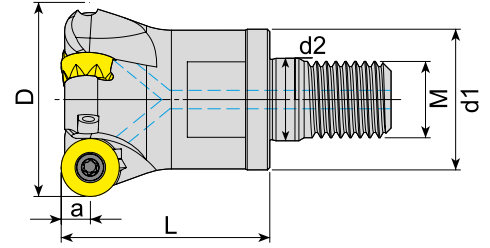

Takım Kodu Ordering Code Код для заказа	Stok Stock Наличие	Takım Ölçüleri (mm) Dimension (mm) Размеры (мм)							Kesici Uç Insert Пластина	Yedek Parçaları / Spare Parts / Запасные части		
		D	Z	d1	M	L	d2	a		Sıkma Vidası Screw Зажимной винт	Tork Anahtar Torx Key Торх Ключ	
AEMR-RY10-D32-M16-L43-Z04-H	●	32	4	29	M16	43	17	5	RYMX 1004..	4015-M3.5x9	80-T15	
AEMR-RY10-D40-M16-L43-Z05-H	●	40	5	29	M16	43	17	5				
AEMR-RY12-D32-M16-L43-Z03-H	●	32	3	29	M16	43	17	6	RYMX 1205..	4015-M4x9	80-T15	
AEMR-RY12-D40-M16-L43-Z03-H	●	40	3	29	M16	43	17	6				

TGTC Ucuna Uyundur. / Compatible with TGTC Insert. / Под пластину TGTC

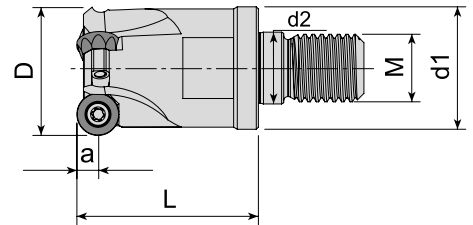

Takım Kodu Ordering Code Код для заказа	Stok Stock Наличие	Takım Ölçüleri (mm) Dimension (mm) Размеры (мм)							Kesici Uç Insert Пластина	Yedek Parçaları / Spare Parts / Запасные части		
		D	Z	d1	M	L	d2	a		Sıkma Vidası Screw Зажимной винт	Tork Anahtar Torx Key Торх Ключ	
AEMR-QP10T3-D25-M12-L35-Z02-H	●	25	2	21	M12	35	12.5	5	QP.. 10T3..	4015-M3.5x9	80-T15	
AEMR-QP10T3-D32-M16-L43-Z03-H	●	32	3	29	M16	43	17	5				

R: Sağ / Right / Правый L: Sol/Left/Левый

● Stokta / In Stock / В наличии ○ Stokta Yok / Non Stock Item / Нет в наличии

SMTM Ucuna Uyundur. / Compatible with SMTM Insert. / Под пластину SMTM

Sipariş Örneği/Ordering Example/Образец заказа

1 ad./pcs./шт AEMR-RY10-D32-M16-L43-Z04-H

Kesme Hesabı : S 321 / Cutting Calculation : P 321 / Расчет режимов резания: стр. 321

Sıkma Tork Değeri : S 320 / Tightening Torque : P 320 / Момент затяжки: стр. 320

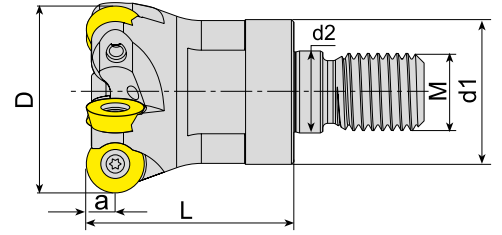

Takım Kodu Ordering Code Код для заказа	Stok Stock Наличие	Takım Ölçüleri (mm) Dimension (mm) Размеры (мм)							Kesici Uç Insert Пластина	Yedek Parçaları / Spare Parts / Запасные части	
		D	Z	d1	M	L	d2	a		Sıkma Vidası Screw Зажимной винт	Tork Anahtar Torx Key Торх Ключ
AEMR-RD0702-D15-M08-L23-Z02-H	●	15	2	13	M08	23	8.5	3.5	RD.. 0702	3008-M2.5x6	80-T08
AEMR-RD0702-D16-M08-L23-Z02-H	●	16	2	13	M08	23	8.5	3.5			
AEMR-RD0702-D20-M10-L30-Z04-H	●	20	4	18	M10	30	10.5	3.5			
AEMR-RD0702-D25-M12-L35-Z05-H	●	25	5	21	M12	35	12.5	3.5			
AEMR-RD0702-D30-M16-L42-Z05-H	●	30	5	29	M16	42	17	3.5			
AEMR-RD0702-D32-M16-L43-Z05-H	●	32	5	29	M16	43	17	3.5			
AEMR-RD0702-D35-M16-L42-Z06-H	●	35	6	29	M16	42	17	3.5			
AEMR-RD0702-D42-M16-L43-Z05-H	●	42	5	29	M16	43	17	3.5			
AEMR-RD0702-D42-M16-L43-Z07-H	●	42	7	29	M16	43	17	3.5			
AEMR-RD08T2-D16-M08-L23-Z02-H	●	16	2	13	M08	23	8.5	4	RD.. 08T2	3008-M2.5x6	80-T15
AEMR-RD08T2-D20-M10-L30-Z03-H	●	20	3	18	M10	30	10.5	4			
AEMR-RD08T2-D25-M12-L35-Z04-H	●	25	4	21	M12	35	12.5	4			
AEMR-RD0802-D16-M08-L23-Z02-H	●	16	2	13	M08	23	8.5	4	RD.. 0802	3008-M3x6	
AEMR-RD0803-D16-M08-L23-Z02-H	●	16	2	13	M08	23	8.5	4	RD.. 0803	3008-M3x8	
AEMR-RD0803-D20-M10-L30-Z03-H	●	20	3	18	M10	30	10.5	4			
AEMR-RD0803-D25-M12-L35-Z04-H	●	25	4	21	M12	35	12.5	4			
AEMR-RD1003-D20-M10-L30-Z02-H	●	20	2	18	M10	30	10.5	5	RD.. 1003	4015-M3.5x9	
AEMR-RD1003-D25-M12-L35-Z02-H	●	25	2	21	M12	35	12.5	5			
AEMR-RD1003-D25-M12-L35-Z03-H	●	25	3	21	M12	35	12.5	5			
AEMR-RD1003-D30-M16-L43-Z04-H	●	30	4	29	M16	43	17	5			
AEMR-RD1003-D32-M16-L43-Z04-H	●	32	4	29	M16	43	17	5			
AEMR-RD1003-D35-M16-L43-Z04-H	●	35	4	29	M16	43	17	5			
AEMR-RD1003-D40-M16-L43-Z05-H	●	40	5	29	M16	43	17	5			
AEMR-RD1003-D42-M16-L43-Z05-H	●	42	5	29	M16	43	17	5			
AEMR-RD1004-D25-M12-L35-Z03-H	●	25	3	21	M12	35	12.5	5	RD.. 1004	4515-M4x8	
AEMR-RD1004-D32-M16-L43-Z04-H	●	32	4	29	M16	43	17	5			
AEMR-RD12T3-D24-M12-L35-Z02-H	●	24	2	21	M12	35	12.5	6	RD.. 12T3	4015-M3.5x9	
AEMR-RD12T3-D25-M12-L35-Z02-H	●	25	2	21	M12	35	12.5	6			
AEMR-RD12T3-D32-M16-L43-Z03-H	●	32	3	29	M16	43	17	6			
AEMR-RD12T3-D35-M16-L43-Z03-H	●	35	3	29	M16	43	17	6			
AEMR-RD12T3-D35-M16-L43-Z04-H	●	35	4	29	M16	43	17	6			
AEMR-RD12T3-D40-M16-L43-Z04-H	●	40	4	29	M16	43	17	6			
AEMR-RD12T3-D42-M16-L43-Z05-H	●	42	5	29	M16	43	17	6			
AEMR-RD1204-D32-M16-L43-Z03-H	●	32	3	29	M16	43	17	6			
AEMR-RD1204-D42-M16-L43-Z04-H	●	42	4	29	M16	43	17	6	RD.. 1204		
AEMR-RD1604-D32-M16-L43-Z02-H	●	32	2	29	M16	43	17	8	RD.. 1604	4015-M4.5x11	
AEMR-RD1604-D40-M16-L43-Z02-H	●	40	2	29	M16	43	17	8			
AEMR-RD1604-D42-M16-L43-Z03-H	●	42	3	29	M16	43	17	8			

R: Sağ / Right / Правый L: Sol/Left/Левый
● Stokta / In Stock / В наличии ○ Stokta Yok / Non Stock Item / Нет в наличии
ISO Uçuna Uygundur. / Compatible with ISO Insert. / Под пластину ISO



www.akkо.com.tr

Sipariş Örneği/Ordering Example/Образец заказа

1 ad./pcs./шт AEMR-RD0702-D15-M08-L23-Z02-H

Kesme Hesabı : S 321 / Cutting Calculation : P 321 / Расчет режимов резания: стр. 321

Sıkma Tork Değeri : S 320 / Tightening Torque : P 320 / Момент затяжки: стр. 320

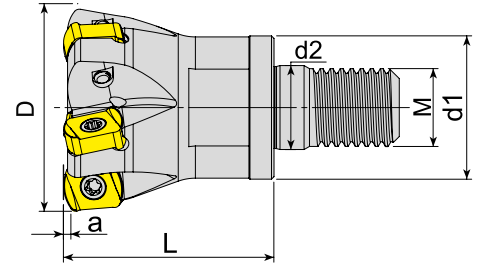

Takım Kodu Ordering Code Код для заказа	Stok Stock Наличие	Takım Ölçüleri (mm) Dimension (mm) Размеры (мм)							Kesici Uç Insert Пластина	Yedek Parçaları / Spare Parts / Запасные части		
		D	Z	d1	M	L	d2	a		Sıkma Vidası Screw Зажимной винт	Tork Anahtar Torx Key Торх Ключ	
AHFM-BL0603-D32-M16-L40-Z05-H	●	32	5	29	M16	40	17	1			3008-M2.5x6	80-T08
AHFM-BL0904-D32-M16-L40-Z04-H	●	32	4	29	M16	40	17	1.5			3010-M3.5x9	80-T10
AHFM-BL0904-D42-M16-L43-Z05-H	●	42	5	29	M16	43	17	1.5				

TGTC Ucuna Uygunudur. / Compatiple with TGTC Insert. / Под пластину TGTC

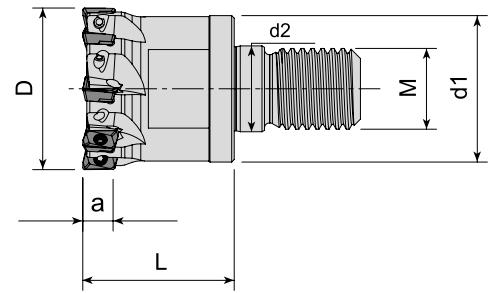

Takım Kodu Ordering Code Код для заказа	Stok Stock Наличие	Takım Ölçüleri (mm) Dimension (mm) Размеры (мм)							Kesici Uç Insert Пластина	Yedek Parçaları / Spare Parts / Запасные части		
		D	Z	d1	M	L	d2	a		Sıkma Vidası Screw Зажимной винт	Tork Anahtar Torx Key Торх Ключ	
AHFM-ED0702-D12-M06-L20-Z03	●	12	3	10	M06	20	6.5	6			3006-M1.8x4	80-T06
AHFM-ED0702-D16-M08-L25-Z04-H	●	16	4	14.75	M08	25	8.5	6				
AHFM-ED0702-D20-M10-L30-Z05-H	●	20	5	18	M10	30	10.5	6				
AHFM-ED0702-D25-M12-L30-Z06-H	●	25	6	21	M12	30	12.5	6				
AHFM-ED0702-D32-M16-L30-Z08-H	●	32	8	29	M16	30	17	6				

R: Sağ / Right / Правый L: Sol/Left/Левый
● Stokta / In Stock / В наличии ○ Stokta Yok / Non Stock Item / Нет в наличии
HTCH Ucuna Uygunudur. / Compatiple with HTCH Insert. / Под пластину HTCH



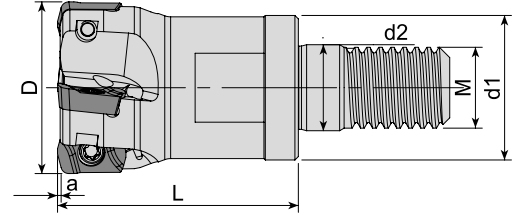



Sipariş Örneği/Ordering Example/Образец заказа
1 ad./pcs./шт AHFM-BL0603-D32-M16-L40-Z05-H
Kesme Hesabı : S 321 / Cutting Calculation : P 321 / Расчет режимов резания: стр. 321
Sıkma Tork Değeri : S 320 / Tightening Torque : P 320 / Момент затяжки: стр. 320

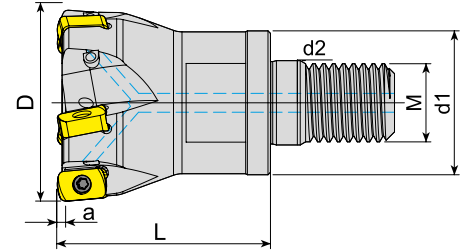

Takım Kodu Ordering Code Код для заказа	Stok Stock Наличие	Takım Ölçüleri (mm) Dimension (mm) Размеры (мм)							Kesici Uç Insert Пластина	Yedek Parçaları / Spare Parts / Запасные части		
		D	Z	d1	M	L	d2	a		Sıkma Vidası Screw Зажимной винт	Tork Anahtar Torx Key Торх Ключ	
AHFM-EP1003-D16-M08-L23-Z02-H	●	16	2	14.75	M08	23	8.5	1	 EP.. 1003.. ZPMT 1003.. YPHW 1003..	 3008-M2.5x5	 80-T08	
AHFM-EP1003-D20-M10-L30-Z04-H	●	20	4	18	M10	30	10.5	1				3008-M2.5x5
AHFM-EP1003-D25-M12-L35-Z04-H	●	25	4	21	M12	35	12.5	1		 3008-M2.5x6		
AHFM-EP1003-D32-M16-L43-Z05-H	●	32	5	29	M16	43	17	1				
AHFM-EP1003-D35-M16-L43-Z05-H	●	35	5	29	M16	43	17	1				
AHFM-EP1003-D42-M16-L43-Z06-H	●	42	6	29	M16	43	17	1				

DJT Ucuna Uygundur. / Compatible with DJT Insert. / Под пластину DJT



Takım Kodu Ordering Code Код для заказа	Stok Stock Наличие	Takım Ölçüleri (mm) Dimension (mm) Размеры (мм)							Kesici Uç Insert Пластина	Yedek Parçaları / Spare Parts / Запасные части			
		D	Z	d1	M	L	d2	a		Sıkma Vidası Screw Зажимной винт	Baskı Parçası Wedge Clamp Прижим	Baskı Vidası Clamp Screw Зажимной винт	Tork Anahtar Torx Key Торх Ключ
AHFM-EN1004-D16-M08-L23-Z02-H	●	16	2	14.75	M08	23	8.5	1	 ENMU 1004..	 3008-M2.5x5	 -	 -	 80-T08
AHFM-EN1004-D20-M10-L30-Z03-H	●	20	3	18	M10	30	10.5	1					
AHFM-EN1004-D25-M12-L35-Z03-H	●	25	3	21	M12	35	12.5	1		 3008-M2.5x6			
AHFM-EN1004-D25-M12-L35-Z04-H	●	25	4	21	M12	35	12.5	1					
AHFM-EN1004-D32-M16-L43-Z05-H	●	32	5	29	M16	43	17	1					
AHFM-EN1004-D35-M16-L43-Z05-H	●	35	5	29	M16	43	17	1					
AHFM-EN1004-D40-M16-L43-Z05-H	●	40	5	29	M16	43	17	1					
AHFM-EN1004-D42-M16-L43-Z05-H	●	42	5	29	M16	43	17	1					

R: Sağ / Right / Правый L: Sol/Left/Левый
● Stokta / In Stock / В наличии ○ Stokta Yok / Non Stock Item / Нет в наличии
DJT Ucuna Uygundur. / Compatible with DJT Insert. / Под пластину DJT

Sipariş Örneği/Ordering Example/Образец заказа
1 ad./pcs./шт AHFM-EP1003-D16-M08-L23-Z02-H
Kesme Hesabı : S 321 / Cutting Calculation : P 321 / Расчет режимов резания: стр. 321
Sıkma Tork Değeri : S 320 / Tightening Torque : P 320 / Момент затяжки: стр. 320

new

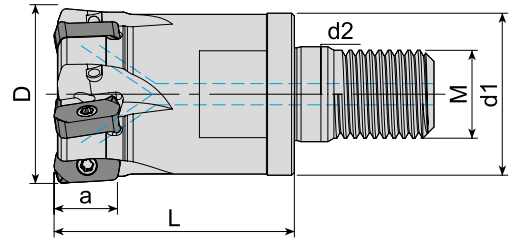

Takım Kodu Ordering Code Код для заказа	Stok Stock Наличие	Takım Ölçüleri (mm) Dimension (mm) Размеры (мм)						Kesici Uç Insert Пластина	Yedek Parçaları / Spare Parts / Запасные части				
		D	Z	d1	M	L	d2		a	Sıkma Vidası Screw Зажимной винт	Baskı Parçası Wedge Clamp Прижим	Baskı Vidası Clamp Screw Зажимной винт	Tork Anahtar Torx Key Торх Ключ
AHFM-LN120-D25-M12-L35-Z04-H	●	25	4	21	M12	35	12.5	12					
AHFM-LN120-D32-M16-L43-Z05-H	●	32	5	29	M16	43	17	12	LNMX 1235..	3008-M2.5x6	-	-	80-T08
AHFM-LN120-D42-M16-L43-Z06-H	●	42	6	29	M16	43	17	12					

B.OKE Ucuna Uygundur. / Compatible with B.OKE Insert. / Под пластину B.OKE

new

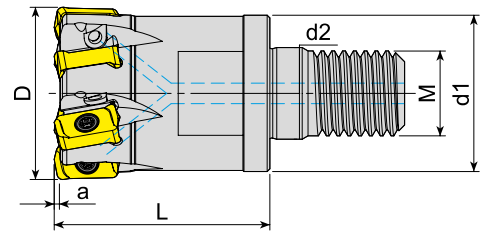

Takım Kodu Ordering Code Код для заказа	Stok Stock Наличие	Takım Ölçüleri (mm) Dimension (mm) Размеры (мм)						Kesici Uç Insert Пластина	Yedek Parçaları / Spare Parts / Запасные части				
		D	Z	d1	M	L	d2		a	Sıkma Vidası Screw Зажимной винт	Baskı Parçası Wedge Clamp Прижим	Baskı Vidası Clamp Screw Зажимной винт	Tork Anahtar Torx Key Торх Ключ
AHFM-L003-D20-M10-L30-Z04-H-F	●	20	4	18	M10	30	10.5	1	LOGU 0303..	1108-M3x6.8	-	-	80-T08
AHFM-L003-D25-M12-L35-Z04-H-F	●	25	4	21	M12	35	12.5	1					
AHFM-L003-D25-M12-L35-Z04-H	●	25	4	21	M12	35	12.5	1					
AHFM-L003-D32-M16-L40-Z05-H-F	●	32	5	29	M16	40	17	1					
AHFM-L003-D32-M16-L40-Z05-H	●	32	5	29	M16	40	17	1					
AHFM-L003-D32-M16-L40-Z06-H-F	●	32	6	29	M16	40	17	1					
AHFM-L003-D32-M16-L40-Z06-H	●	32	6	29	M16	40	17	1					
AHFM-L003-D42-M16-L40-Z05-H	●	42	5	29	M16	40	17	1					
AHFM-L003-D42-M16-L40-Z06-H	●	42	6	29	M16	40	17	1					

R: Sağ / Right / Правый L: Sol/Left/Левый

● Stokta / In Stock / В наличии ○ Stokta Yok / Non Stock Item / Нет в наличии

KYCR Ucuna Uygundur. / Compatible with KYCR Insert. / Под пластину KYCR

Sipariş Örneği/Ordering Example/Образец заказа

1 ad./pcs./шт AHFM-LN120-D25-M12-L35-Z04-H

Kesme Hesabı : S 321 / Cutting Calculation : P 321 / Расчет режимов резания: стр. 321

Sıkma Tork Değeri : S 320 / Tightening Torque : P 320 / Момент затяжки: стр. 320

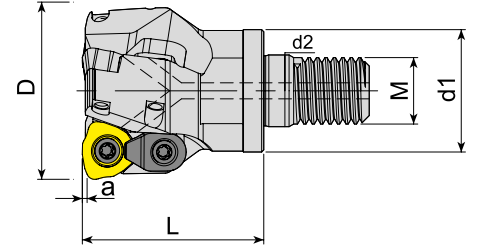

Takım Kodu Ordering Code Код для заказа	Stok Stock Наличие	Takım Ölçüleri (mm) Dimension (mm) Размеры (мм)							Kesici Uç Insert Пластина	Yedek Parçaları / Spare Parts / Запасные части			
		D	Z	d1	M	L	d2	a		Sikma Vidası Screw Зажимной винт	Baskı Parçası Wedge Clamp Прижим	Baskı Vidası Clamp Screw Зажимной винт	Tork Anahtar Torx Key Торх Ключ
AHFMC-JD1204-D32-M16-L43-Z02-H	●	32	2	29	M16	43	17	1.5	JDMW 1204..				
AHFMC-JD1204-D42-M16-L43-Z03-H	●	42	3	29	M16	43	17	1.5					

MTSBSH Ucuna Uygunudur. / Compatible with MTSBSH Insert. / Под пластину MTSBSH

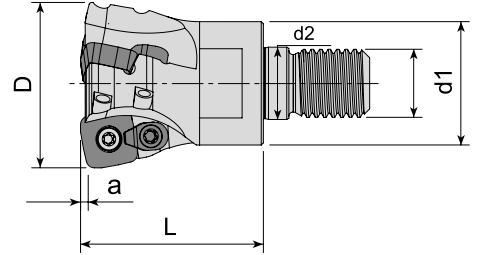

Takım Kodu Ordering Code Код для заказа	Stok Stock Наличие	Takım Ölçüleri (mm) Dimension (mm) Размеры (мм)							Kesici Uç Insert Пластина	Yedek Parçaları / Spare Parts / Запасные части			
		D	Z	d1	M	L	d2	a		Sikma Vidası Screw Зажимной винт	Baskı Parçası Wedge Clamp Прижим	Baskı Vidası Clamp Screw Зажимной винт	Tork Anahtar Torx Key Торх Ключ
AHFMC-SD09T3-D25-M12-L30-Z02-H	●	25	2	22	M12	30	12.5	1.4	SD.. 09T3..				
AHFMC-SD09T3-D32-M16-L43-Z03-H	●	32	3	29	M16	43	17	1.4					
AHFMC-SD1204-D32-M16-L43-Z02-H	●	32	2	29	M16	43	17	1.8	SD.. 1204..				
AHFMC-SD1204-D40-M16-L43-Z03-H	●	40	3	29	M16	43	17	1.8					

R: Sağ / Right / Правый L: Sol/Left/Левый
● Stokta / In Stock / В наличии ○ Stokta Yok / Non Stock Item / Нет в наличии
ZCC Ucuna Uygunudur. / Compatible with ZCC Insert. / Под пластину ZCC

Sipariş Örneği/Ordering Example/Образец заказа
1 ad./pcs./шт AHFMC-JD1204-D32-M16-L43-Z02-H
Kesme Hesabı : S 321 / Cutting Calculation : P 321 / Расчет режимов резания: стр. 321
Sikma Tork Değeri : S 320 / Tightening Torque : P 320 / Момент затяжки: стр. 320

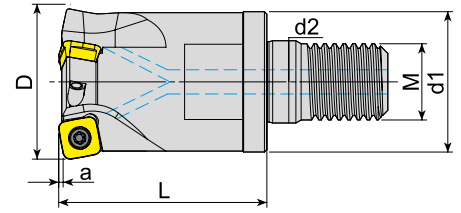

Takım Kodu Ordering Code Код для заказа	Stok Stock Наличие	Takım Ölçüleri (mm) Dimension (mm) Размеры (мм)						Kesici Uç Insert Пластина	Yedek Parçaları / Spare Parts / Запасные части				
		D	Z	d1	M	L	d2		a	Sıkma Vidası Screw Зажимной винт	Baskı Parçası Wedge Clamp Прижим	Baskı Vidası Clamp Screw Зажимной винт	Tork Anahtar Torx Key Торх Ключ
AHFM-SO0803-D20-M10-L30-Z02-H	●	20	2	18	M10	30	10.5	1	SOMW 0803..	4010-M3X8	-	-	80-T10
AHFM-SO0803-D25-M12-L35-Z03-H	●	25	3	22	M12	35	12.5	1					
AHFM-SO0803-D32-M16-L43-Z03-H	●	32	3	29	M16	43	17	1					
AHFM-SO0803-D32-M16-L43-Z04-H	●	32	4	29	M16	43	17	1					
AHFM-SO0803-D40-M16-L43-Z04-H	●	40	4	29	M16	43	17	1					

KPTK Ucuna Uygundur. / Compatiple with KPTK Insert. / Под пластину KPTK

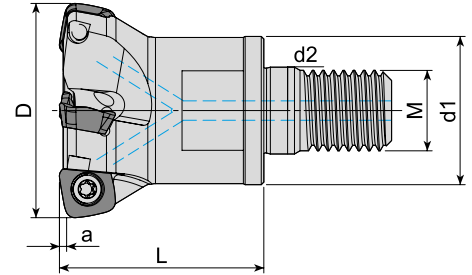

Takım Kodu Ordering Code Код для заказа	Stok Stock Наличие	Takım Ölçüleri (mm) Dimension (mm) Размеры (мм)						Kesici Uç Insert Пластина	Yedek Parçaları / Spare Parts / Запасные части				
		D	Z	d1	M	L	d2		a	Sıkma Vidası Screw Зажимной винт	Baskı Parçası Wedge Clamp Прижим	Baskı Vidası Clamp Screw Зажимной винт	Tork Anahtar Torx Key Торх Ключ
AHFM-SO1004-D32-M16-L40-Z03-H	●	32	3	29	M16	40	17	1.5	SOMT 1004..	4015-M4x9	-	-	80-T15
AHFM-SO1004-D40-M16-L40-Z04-H	●	40	4	29	M16	40	17	1.5					
AHFM-SO1004-D42-M16-L40-Z04-H	●	42	4	29	M16	40	17	1.5					

R: Sağ / Right / Правый L: Sol/Left/Левый

● Stokta / In Stock / В наличии ○ Stokta Yok / Non Stock Item / Нет в наличии

KYCR Ucuna Uygundur. / Compatiple with KYCR Insert. / Под пластину KYCR

Sipariş Örneği/Ordering Example/Образец заказа

1 ad./pcs./шт AHFM-SO0803-D20-M10-L30-Z02-H

Kesme Hesabı : S 321 / Cutting Calculation : P 321 / Расчет режимов резания: стр. 321

Sıkma Tork Değeri : S 320 / Tightening Torque : P 320 / Момент затяжки: стр. 320

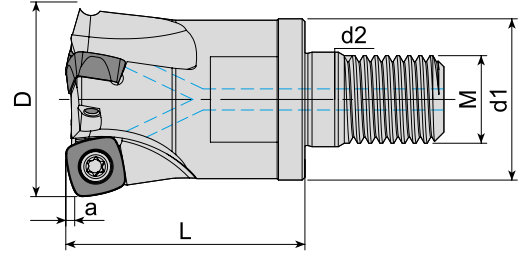

Takım Kodu Ordering Code Код для заказа	Stok Stock Наличие	Takım Ölçüleri (mm) Dimension (mm) Размеры (мм)						Kesici Uç Insert Пластина	Yedek Parçaları / Spare Parts / Запасные части				
		D	Z	d1	M	L	d2		a	Sikma Vidası Screw Зажимной винт	Baskı Parçası Wedge Clamp Прижим	Baskı Vidası Clamp Screw Зажимной винт	Tork Anahtar Torx Key Торх Ключ
AHFM-SP1004-D32-M16-L43-Z03-H	●	32	3	29	M16	43	17	1.5	SPNW 1004..	3015-M3.5x9	-	-	80-T15
AHFM-SP1004-D35-M16-L43-Z03-H	●	35	3	29	M16	43	17	1.5					
AHFM-SP1004-D42-M16-L43-Z04-H	●	42	4	29	M16	43	17	1.5					

DJT Ucuna Uygundur. / Compatible with DJT Insert. / Под пластину DJT

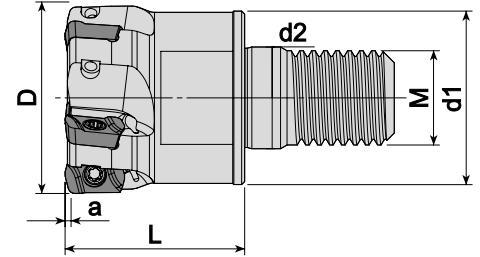

Takım Kodu Ordering Code Код для заказа	Stok Stock Наличие	Takım Ölçüleri (mm) Dimension (mm) Размеры (мм)						Kesici Uç Insert Пластина	Yedek Parçaları / Spare Parts / Запасные части								
		D	Z	d1	M	L	d2		a	Sikma Vidası Screw Зажимной винт	Baskı Parçası Wedge Clamp Прижим	Baskı Vidası Clamp Screw Зажимной винт	Tork Anahtar Torx Key Торх Ключ				
AHFM-YP1003-D16-M08-L23-Z02-F	●	16	2	14.75	M08	23	8.5	1	YPHW 1003..	3008-M2.5x5	-	-	80-T08				
AHFM-YP1003-D16-M08-L23-Z02-H-F	●	16	2	14.75	M08	23	8.5	1									
AHFM-YP1003-D17-M08-L23-Z02-H-F	●	17	2	14.75	M08	23	8.5	1									
AHFM-YP1003-D20-M10-L30-Z03-H-F	●	20	3	18	M10	30	10.5	1									
AHFM-YP1003-D20-M10-L30-Z04-F	●	20	4	18	M10	30	10.5	1									
AHFM-YP1003-D21-M10-L30-Z03-H-F	●	21	3	18	M10	30	10.5	1									
AHFM-YP1003-D25-M12-L35-Z04-F	●	25	4	21	M12	35	12.5	1									
AHFM-YP1003-D25-M12-L35-Z04-H-F	●	25	4	21	M12	35	12.5	1									
AHFM-YP1003-D26-M12-L35-Z04-H-F	●	26	4	21	M12	35	12.5	1									
AHFM-YP1003-D32-M16-L30-Z05-F	●	32	5	29	M16	30	17	1									
AHFM-YP1003-D32-M16-L43-Z05-H-F	●	32	5	29	M16	43	17	1									
AHFM-YP1003-D40-M16-L43-Z06-H-F	●	40	6	29	M16	43	17	1									
AHFM-YP1003-D42-M16-L43-Z06-H-F	●	42	6	29	M16	43	17	1									
														3008-M2.5x6			

R: Sağ / Right / Правый L: Sol/Left/Левый

● Stokta / In Stock / В наличии ○ Stokta Yok / Non Stock Item / Нет в наличии

DJT Ucuna Uygundur. / Compatible with DJT Insert. / Под пластину DJT

Sipariş Örneği/Ordering Example/Образец заказа

1 ad./pcs./шт AHFM-SP1004-D32-M16-L43-Z03-H

Kesme Hesabı : S 321 / Cutting Calculation : P 321 / Расчет режимов резания: стр. 321

Sikma Tork Değeri : S 320 / Tightening Torque : P 320 / Момент затяжки: стр. 320



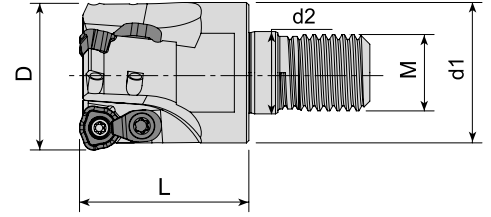

Takım Kodu Ordering Code Код для заказа	Stok Stock Наличие	Takım Ölçüleri (mm) Dimension (mm) Размеры (мм)						Kesici Uç Insert Пластина	Yedek Parçaları / Spare Parts / Запасные части				
		D	Z	d1	M	L	d2		a	Sıkma Vidası Screw Зажимной винт	Baskı Parçası Wedge Clamp Прижим	Baskı Vidası Clamp Screw Зажимной винт	Tork Anahtar Torx Key Торх Ключ
AHFMC-WD0804-D25-M12-L35-Z02-H	●	25	2	21	M12	35	12.5	-					
AHFMC-WD0804-D32-M16-L35-Z03-H	●	32	3	29	M16	35	17	-	WDMT 0804..	4010-M3x8	ACK-15	4010-M3x8	80-T10

SMTM Ucuna Uygundur. / Compatible with SMTM Insert. / Под пластину SMTM

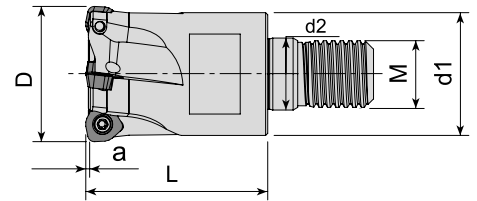

Takım Kodu Ordering Code Код для заказа	Stok Stock Наличие	Takım Ölçüleri (mm) Dimension (mm) Размеры (мм)						Kesici Uç Insert Пластина	Yedek Parçaları / Spare Parts / Запасные части								
		D	Z	d1	M	L	d2		a	Sıkma Vidası Screw Зажимной винт	Baskı Parçası Wedge Clamp Прижим	Baskı Vidası Clamp Screw Зажимной винт	Tork Anahtar Torx Key Торх Ключ				
AHFM-WD0503D-D20-M10-L30-Z02-H	●	20	2	18	M10	30	10.5	1.25		4010-M3x6							
AHFM-WD0503D-D25-M12-L35-Z03-H	●	25	3	21	M12	35	12.5	1.25		WDMT 0503..				4010-M3x8	-	-	80-T10
AHFM-WD0503D-D32-M16-L43-Z04-H	●	32	4	29	M16	43	17	1.25									
AHFM-WD0503D-D40-M16-L43-Z05-H	●	40	5	29	M16	43	17	1.25									
AHFMC-WD06T3D-D35-M16-L43-Z03-H	●	35	3	29	M16	43	17	1.5	WDHW 06T3..	3015-M3.5x9	ACK-15	4015-M3.5x11	80-T15				
AHFMC-WD0805D-D32-M16-L43-Z02-H	●	32	2	29	M16	43	17	2	WDHW 0805..	4020-M4.5x10	ACK-19	4020-M4.5x12					

R: Sağ / Right / Правый L: Sol/Left/Левый

● Stokta / In Stock / В наличии ○ Stokta Yok / Non Stock Item / Нет в наличии

DJT Ucuna Uygundur. / Compatible with DJT Insert. / Под пластину DJT

Sipariş Örneği/Ordering Example/Образец заказа

1 ad./pcs./шт AHFMC-WD0804-D25-M12-L35-Z02-H

Kesme Hesabı : S 321 / Cutting Calculation : P 321 / Расчет режимов резания: стр. 321

Sıkma Tork Değeri : S 320 / Tightening Torque : P 320 / Момент затяжки: стр. 320

➤ S-SİSTEM HIZLI İLERLEMELİ MODÜLER PARMAK FREZELER
S-SYSTEM MODULAR (SCREW TYPE) HIGHFEED END MILLS
S-ТИП ВЫСОКОПРОИЗВОДИТЕЛЬНЫЕ СМЕННЫЕ ФРЕЗЕРНЫЕ ГОЛОВКИ

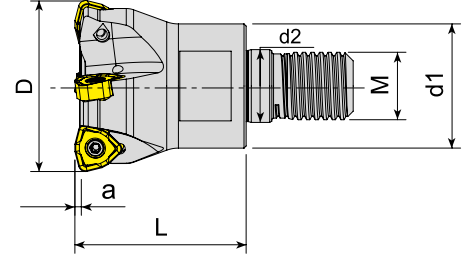

Takım Kodu Ordering Code Код для заказа	Stok Stock Наличие	Takım Ölçüleri (mm) Dimension (mm) Размеры (мм)							Kesici Uç Insert Пластина	Yedek Parçaları / Spare Parts / Залпасные части		
		D	Z	d1	M	L	d2	a		Sikma Vidası Screw Зажимной винт	Tork Anahtar Torx Key Торх Ключ	
AHFM-WN09T3-D32-M16-L40-Z03-H	●	32	3	29	M16	40	17	1.5	WNMX 09T3..	4010-M3x8	80-T10	
AHFM-WN09T3-D40-M16-L40-Z04-H	●	40	4	29	M16	40	17	1.5				

KRLY Ucuna Uygunur. / Compatiple with KRLY Insert. / Под пластину KRLY

➤ KÜRE UÇLU PARMAK FREZELER
BALL NÖSE END MILLS
СФЕРИЧЕСКИЕ КОНЦЕВЫЕ ФРЕЗЫ

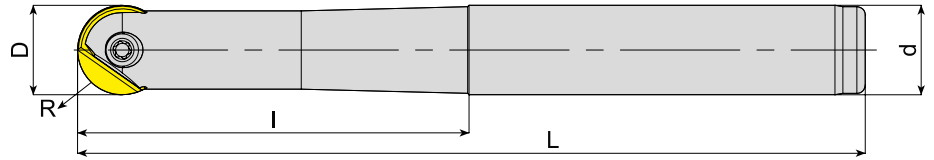

Takım Kodu Ordering Code Код для заказа	Stok Stock Наличие	Takım Ölçüleri (mm) Dimension (mm) Размеры (мм)					Kesici Uç Insert Пластина	Yedek Parçaları / Spare Parts / Залпасные части		
		D	R	d	L	l		Sikma Vidası Screw Зажимной винт	Tork Anahtar Torx Key Торх Ключ	
APMR-BNM12-D12-C12-L130	●	12	6	12	130	32	BNM 120-S	1210-M3.5x9.6	80-T10	
APMR-BNM16-D16-C16-L175	●	16	8	16	175	70				BNM 160-S

R: Sağ / Right / Правый L: Sol/Left/Левый

● Stokta / In Stock / В наличии ○ Stokta Yok / Non Stock Item / Нет в наличии
DJT Ucuna Uygunur. / Compatiple with DJT Insert. / Под пластину DJT

Sipariş Örneği/Ordering Example/Образец заказа

1 ad./pcs./шт AHFM-WN09T3-D32-M16-L40-Z03-H

Kesme Hesabı : S 321 / Cutting Calculation : P 321 / Расчет режимов резания: стр. 321



www.akkо.com.tr

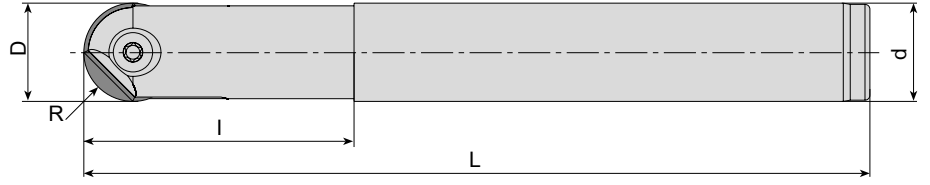

Takım Kodu Ordering Code Код для заказа	Stok Stock Наличие	Takım Ölçüleri (mm) Dimension (mm) Размеры (мм)					Kesici Uç Insert Пластина	Yedek Parçaları / Spare Parts / Запасные части		
		D	R	d	L	I		Sıkma Vidası Screw Зажимной винт	Tork Anahtar Torx Key Торх Ключ	
APMR-R012-D12-C12-L120	●	12	6	12	120	35				
APMR-R012-D12-C16-L160	●	12	6	16	160	50				
APMR-R016-D16-C16-L160	●	16	8	16	160	45				
APMR-R016-D16-C16-L200	●	16	8	16	200	45	ROHX 1604	1220-M5x0.5x12	80-T20	
APMR-R016-D16-C20-L200	●	16	8	20	200	65				
APMR-R020-D20-C20-L160	●	20	10	20	160	55	ROHX 2005	1220-M5x0.5x15	80-T20	
APMR-R020-D20-C20-L200	●	20	10	20	200	55				
APMR-R020-D20-C25-L220	●	20	10	25	220	80				

ZCC Ucuna Uygun. / Compatible with ZCC Insert. / Под пластину ZCC

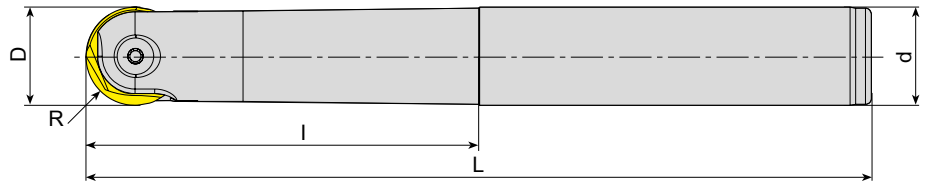

Takım Kodu Ordering Code Код для заказа	Stok Stock Наличие	Takım Ölçüleri (mm) Dimension (mm) Размеры (мм)					Kesici Uç Insert Пластина	Yedek Parçaları / Spare Parts / Запасные части		
		D	R	d	L	I		Sıkma Vidası Screw Зажимной винт	Tork Anahtar Torx Key Торх Ключ	
APMR-P3208-D08-C10-L110	●	8	4	10	110	25				
APMR-P3210-D10-C10-L130	●	10	5	10	130	30				
APMR-P3210-D10-C12-L130	●	10	5	12	130	30	P3210	1215-M4x0.5x9	80-T15	
APMR-P3212-D12-C12-L130	●	12	6	12	130	32				
APMR-P3216-D16-C16-L175	●	16	8	16	175	60				
APMR-P3220-D20-C20-L200	●	20	10	20	200	100	P3220	1220-M5x0.5x15	80-T20	
APMR-P3225-D25-C25-L200	●	25	12.5	25	200	100				
APMR-P3232-D32-C32-L200	●	32	16	32	200	100	P3232	1204-M8x0.75x26	AAL-05-4	

R: Sağ / Right / Правый L: Sol/Left/Левый

● Stokta / In Stock / В наличии ○ Stokta Yok / Non Stock Item / Нет в наличии

WLTR Ucuna Uygun. / Compatible with WLTR Insert. / Под пластину WLTR

Sipariş Örneği/Ordering Example/Образец заказа

1 ad./pcs./шт APMR-R012-D12-C12-L120

Kesme Hesabı : S 321 / Cutting Calculation : P 321 / Расчет режимов резания: стр. 321

➤ **KÜRE UÇLU PARMAK FREZELER**
BALL NOSE END MILLS
СФЕРИЧЕСКИЕ КОНЦЕВЫЕ ФРЕЗЫ

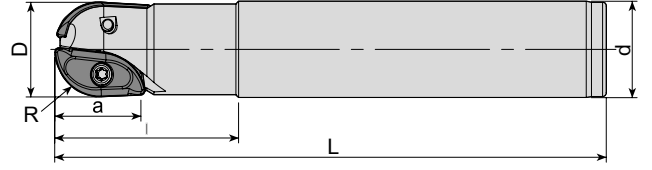

Takım Kodu Ordering Code Код для заказа	Stok Stock Наличие	Takım Ölçüleri (mm) Dimension (mm) Размеры (мм)					Kesici Uç Insert Пластина	Yedek Parçaları / Spare Parts / Запасные части		
		D	R	d	L	l		Sıkma Vidası Screw Зажимной винт	Tork Anahtar Torx Key Торх Ключ	
APMR-XP16-D16-C16-L150	●	16	8	16	150	40				
APMR-XP20-D20-C20-L150	●	20	10	20	150	50				
APMR-XP25-D25-C25-L150	●	25	12.5	25	150	50				

ZCC Ucuna Uygundur. / Compatible with ZCC Insert. / Под пластину ZCC

➤ **KÜRE UÇLU MODÜLER PARMAK FREZELER**
BALL NOSE MODULAR (SCREW TYPE) END MILLS
С-ТИП СМЕННЫЕ СФЕРИЧЕСКИЕ ФРЕЗЕРНЫЕ ГОЛОВКИ (КРЕПЛЕНИЕ ПОД РЕЗЬБУ)

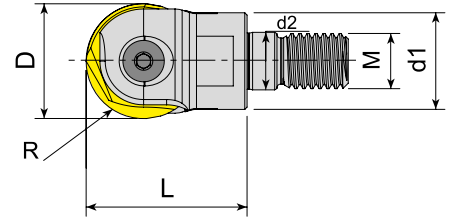

Takım Kodu Ordering Code Код для заказа	Stok Stock Наличие	Takım Ölçüleri (mm) Dimension (mm) Размеры (мм)						Kesici Uç Insert Пластина	Yedek Parçaları / Spare Parts / Запасные части		
		D	R	d1	M	L	d2		Sıkma Vidası Screw Зажимной винт	Tork Anahtar Torx Key Торх Ключ	
APMR-P3216-D16-M08-L25	●	16	8	14	M08	25	8.5				
APMR-P3220-D20-M10-L30	●	20	10	18	M10	30	10.5				
APMR-P3225-D25-M12-L35	●	25	12.5	21	M12	35	12.5				
APMR-P3232-D32-M16-L43	●	32	16	30	M16	43	17				

R: Sağ / Right / Правый L: Sol/Left/Левый

● Stokta / In Stock / В наличии ○ Stokta Yok / Non Stock Item / Нет в наличии

WLTR Ucuna Uygundur. / Compatible with WLTR Insert. / Под пластину WLTR

Sipariş Örneği/Ordering Example/Образец заказа

1 ad./pcs./шт APMR-P3216-D16-M08-L25

Kesme Hesabı : S 321 / Cutting Calculation : P 321 / Расчет режимов резания: стр. 321

Sıkma Tork Değeri : S 320 / Tightening Torque : P 320 / Момент затяжки: стр. 320

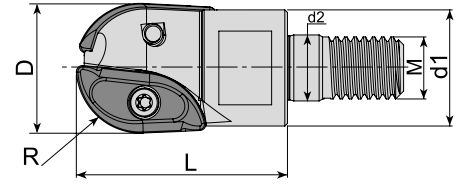

Takım Kodu Ordering Code Код для заказа	Stok Stock Наличие	Takım Ölçüleri (mm) Dimension (mm) Размеры (мм)						Kesici Uç Insert Пластина	Yedek Parçaları / Spare Parts / Запасные части		
		D	R	d1	M	L	d2		Sıkma Vidası Screw Зажимной винт	Tork Anahtar Torx Key Торх Ключ	
APMR-SWB225-D25-M12-L35	●	25	12.5	23.5	M12	35	12.5				
APMR-SWB230-D30-M16-L43	●	30	15	28	M16	43	17		1020-M5x11	80-T20	
APMR-SWB232-D32-M16-L43	●	32	16	30	M16	43	17				

DJT Ucuna Uygunudur. / Compatible with DJT Insert. / Под пластину DJT

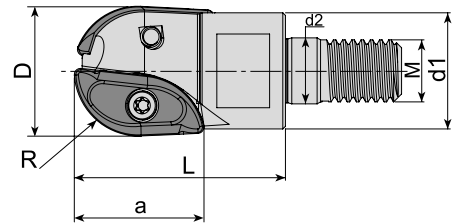

Takım Kodu Ordering Code Код для заказа	Stok Stock Наличие	Takım Ölçüleri (mm) Dimension (mm) Размеры (мм)							Kesici Uç Insert Пластина	Yedek Parçaları / Spare Parts / Запасные части		
		D	R	d1	M	L	a	d2		Sıkma Vidası Screw Зажимной винт	Tork Anahtar Torx Key Торх Ключ	
APMR-XP16-D16-M08-L25	●	16	8	14.75	M08	25	16	8.5				
APMR-XP20-D20-M10-L30	●	20	10	18	M10	30	20	10.5				
APMR-XP25-D25-M12-L40	●	25	12.5	22	M12	40	25	12.5				

R: Sağ / Right / Правый L: Sol/Left/Левый
● Stokta / In Stock / В наличии ○ Stokta Yok / Non Stock Item / Нет в наличии
ZCC Ucuna Uygunudur. / Compatible with ZCC Insert. / Под пластину ZCC

Sipariş Örneği/Ordering Example/Образец заказа
1 ad./pcs./шт APMR-SWB225-D25-M12-L35
Kesme Hesabı : S 321 / Cutting Calculation : P 321 / Расчет режимов резания: стр. 321
Sıkma Tork Değeri : S 320 / Tightening Torque : P 320 / Момент затяжки: стр. 320

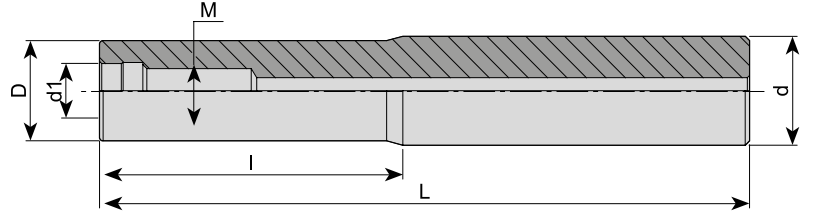

Takım Kodu
Ordering Code
Код для заказа

Stok
Stock
Наличие

Takım Ölçüleri (mm)
Dimension (mm)
Размеры (мм)

Takım Kodu Ordering Code Код для заказа	Stok Stock Наличие	d	M	d1	D	L	l
AVTT-D13-C16-M08-L100-H	●	16	M08	8.5	13	100	40
AVTT-D15-C16-M08-L130-H	●	16	M08	8.5	15	130	70
AVTT-D18-C20-M10-L130-H	●	20	M10	10.5	18	130	70
AVTT-D18-C20-M10-L160-H	●	20	M10	10.5	18	160	80
AVTT-D23-C25-M12-L150-H	●	25	M12	12.5	23	150	70
AVTT-D23-C25-M12-L200-H	●	25	M12	12.5	23	200	100
AVTT-D23-C25-M12-L250-H	●	25	M12	12.5	23	250	150
AVTT-D30-C32-M16-L150-H	●	32	M16	17	30	150	70
AVTT-D30-C32-M16-L200-H	●	32	M16	17	30	200	100
AVTT-D30-C32-M16-L250-H	●	32	M16	17	30	250	150
AVTT-D30-C32-M16-L300-H	●	32	M16	17	30	300	200

R: Sağ / Right / Правый L: Sol/Left/Левый

● Stokta / In Stock / В наличии ○ Stokta Yok / Non Stock Item / Нет в наличии

Sipariş Örneği/Ordering Example/Образец заказа
1 ad./pcs./шт AVTT-D13-C16-M08-L100-H



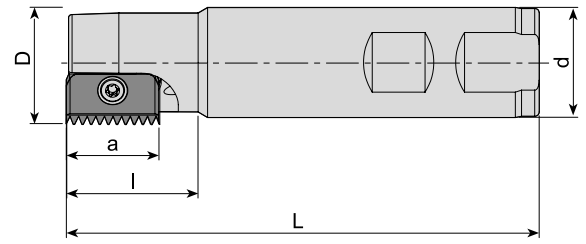

Takım Kodu Ordering Code Код для заказа	Stok Stock Наличие	Takım Ölçüleri (mm) Dimension (mm) Размеры (мм)						Kesici Uç Insert Пластина	Yedek Parçaları / Spare Parts / Запасные части		
		D	Z	d	L	l	a		Sıkma Vidası Screw Зажимной винт	Tork Anahtar Torx Key Торх Ключ	
ATM-C14-D14-W20-L100-Z01-H	●	14	1	20	100	25	14	C14	3008-M2.5x6	80-T08	
ATM-C21-D18-W20-L100-Z01-H	●	18	1	20	100	30	21		4015-M4x9		
ATM-C21-D21-W25-L125-Z01-H	●	21	1	25	125	40	21	C21	4015-M4x11	80-T15	
ATM-C21-D25-W20-L125-Z01-H	●	25	1	20	125	30	21				
ATM-C21-D28-W25-L90-Z01-H	●	28	1	25	90	30	21				
ATM-C21-D38-W32-L90-Z03-H	●	38	3	32	90	30	21				
ATM-C21-D38-W32-L120-Z03-H	●	38	3	32	120	30	21				
ATM-C21-D43-W32-L90-Z03-H	●	43	3	32	90	30	21	C30	1020-M5x14	80-T20	
ATM-C30-D29-W25-L150-Z01-H	●	29	1	25	150	50	30				

CPT Ucuna Uygun. / Compatible with CPT Insert. / Под пластину CPT

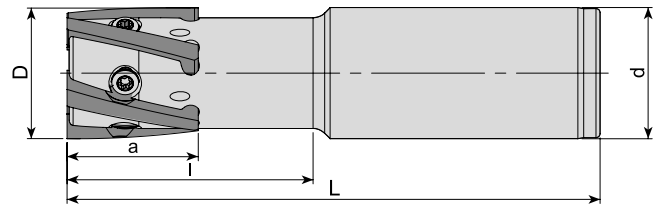

Takım Kodu Ordering Code Код для заказа	Stok Stock Наличие	Takım Ölçüleri (mm) Dimension (mm) Размеры (мм)						Kesici Uç Insert Пластина	Yedek Parçaları / Spare Parts / Запасные части		
		D	Z	d	L	l	a		Sıkma Vidası Screw Зажимной винт	Tork Anahtar Torx Key Торх Ключ	
ATM-H23-D23-C25-L100-Z02-H	●	23	2	25	100	30	27	H23	1015-M4x8	80-T15	
ATM-H32-D32-C32-L130-Z05-H	●	32	5	32	130	35	32	H32	1720-U8-32x10	80-T20	

R: Sağ / Right / Правый L: Sol/Left/Левый

● Stokta / In Stock / В наличии ○ Stokta Yok / Non Stock Item / Нет в наличии



CPT Ucuna Uygun. / Compatible with CPT Insert. / Под пластину CPT

Sipariş Örneği/Ordering Example/Образец заказа

1 ad./pcs./шт ATM-C14-D14-W20-L100-Z01-H

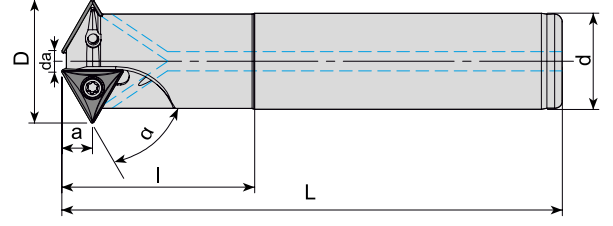
Kesme Hesabı : S 321 / Cutting Calculation : P 321 / Расчет режимов резания : стр. 321



Takım Kodu Ordering Code Код для заказа	Stok Stock Наличие	Takım Ölçüleri (mm) Dimension (mm) Размеры (мм)								Kesici Uç Insert Пластина	Yedek Parçaları / Spare Parts / Запасные части		
		α	D	d	da	L	l	Z	a		Sıkma Vidası Screw Зажимной винт	Tork Anahtar Torx Key Торх Ключ	
ATM60-TB0601-D13-C10-L150-Z02-H	●	60	13	10	2.5	150	40	2	3.3				
ATM60-TC0902-D20.5-C16-L150-Z02-H	●	60	20.5	16	5.2	150	40	2	4.7	TBGT 060102	3006-M2x4	80-T06	
ATM60-TC1102-D26-C20-L150-Z03-H	●	60	26	20	8.3	150	50	3	5.4	TC.T 090202	3007-M2.2x5	80-T07	
ATM60-TC16T3-D32-C25-L150-Z02-H	●	60	32	25	6.4	150	50	2	8	TC.T 110202	3008-M2.5x6	80-T08	
ATM60-TC16T3-D40-C32-L250-Z03-H	●	60	40	32	13.7	250	50	3	8	TC.T 16T304	4015-M3.5x9	80-T15	

R: Sağ / Right / Правый L: Sol/Left/ Левый
● Stokta / In Stock / В наличии ○ Stokta Yok / Non Stock Item / Нет в наличии
ISO Uçuna Uygundur. / Compatible with ISO Insert. / Под пластину ISO

Sipariş Örneği/Ordering Example/ Образец заказа
1 ad./pcs./шт ATM60-TB0601-D13-C10-L150-Z02-H
Kesme Hesabı : S 321 / Cutting Calculation : P 321 / Расчет режимов резания: стр. 321



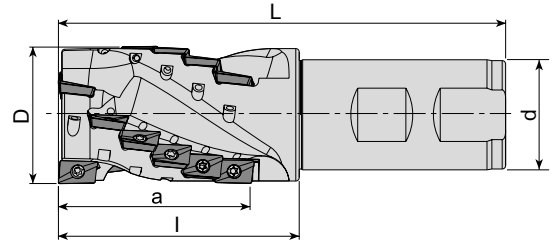
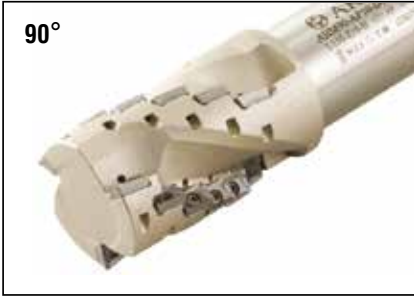

Takım Kodu
Ordering Code
Код для заказа

Takım Kodu Ordering Code Код для заказа	Stok Stock Наличие	Takım Ölçüleri (mm) Dimension (mm) Размеры (мм)							Kesici Uç Insert Пластина	Yedek Parçaları / Spare Parts / Запасные части	
		Z		D	d	a	l	L		Sıkma Vidası Screw Зажимной винт	Tork Anahtar Torx Key Торх Ключ
		Toplam Total Общее	Etkili Effective Эффективное								
AHM90-AP10-D20-W20-L087-Z0204	●	4	2	20	20	28	37	87	AP.. 1003..	3008-M2.5x6	80-T08
AHM90-AP10-D20-W20-L087-Z0206	●	6	2	20	20	28	37	87			
AHM90-AP10-D25-W25-L105-Z0208-H	●	8	2	25	25	37	50	105			
AHM90-AP10-D32-W32-L115-Z0315-H	●	15	3	32	32	46	55	115			
AHM90-AP10-D40-W32-L130-Z0318-H	●	18	3	40	32	55	70	130			

R: Sağ / Right / Правый L: Sol/Left/Левый
● Stokta / In Stock / В наличии ○ Stokta Yok / Non Stock Item / Нет в наличии
ISO Uçuna Uygunudur. / Compatible with ISO Insert. / Под пластину ISO

Sipariş Örneği/Ordering Example/Образец заказа
1 ad./pcs./шт AHM90-AP10-D20-W20-L087-Z0204
Kesme Hesabı : S 321 / Cutting Calculation : P 321 / Расчет режимов резания: стр. 321



42°

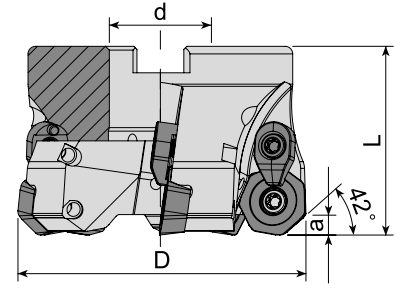

Takım Kodu Ordering Code Код для заказа	Stok Stock Наличие	Takım Ölçüleri (mm) Dimension (mm) Размеры (мм)					Kesici Uç Insert Пластина	Yedek Parçaları / Spare Parts / Запасные части					
		D	Z	d	L	a		Sıkma Vidası Screw Зажимной винт	Baskı Parçası Wedge Clamp Прижим	Baskı Vidası Clamp Screw Зажимной винт	Tork Anahtar Torx Key Торх Ключ	Montaj Vidası Mounting Screw Монтажный винт	
AFM42C-XD0806-D063-A27-Z04-H	●	63	4	27	50	12	XDMW 0806..	4020-M4.5x12	ACK-24	4020-M4.5x12	80-T20	2510-M12x35	
AFM42C-XD0806-D080-A27-Z05-H	●	80	5	27	50	12							
AFM42C-XD0806-D100-A32-Z06-H	●	100	6	32	63	12							2514-M16x35
AFM42C-XD0806-D125-B40-Z07	●	125	7	40	63	12							-
AFM42C-XD0806-D160-C40-Z08	●	160	8	40	63	12							-
AFM42C-XD0806-D200-C60-Z09	●	200	9	60	63	12							-

DJT Ucuna Uygundur. / Compatible with DJT Insert. / Под пластину DJT

43°

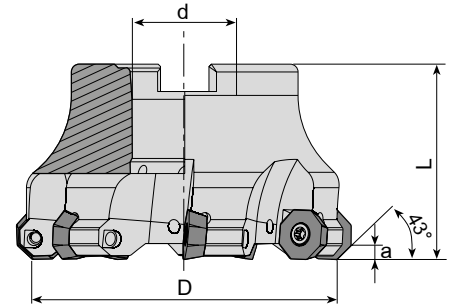

Takım Kodu Ordering Code Код для заказа	Stok Stock Наличие	Takım Ölçüleri (mm) Dimension (mm) Размеры (мм)					Kesici Uç Insert Пластина	Yedek Parçaları / Spare Parts / Запасные части			
		D	Z	d	L	a		Sıkma Vidası Screw Зажимной винт	Tork Anahtar Torx Key Торх Ключ	Montaj Vidası Mounting Screw Монтажный винт	
AFM43-OD0504-D040-A16-Z04-H	●	40	4	16	40	3.5	OD.. 0504..	4015-M3.5x11	80-T15	2506-M8x30	
AFM43-OD0504-D050-A22-Z05-H	●	50	5	22	40	3.5					
AFM43-OD0504-D063-A22-Z06-H	●	63	6	22	40	3.5					2407-M10x30
AFM43-OD0504-D080-A27-Z07-H	●	80	7	27	50	3.5					2510-M12x35
AFM43-OD0504-D100-A32-Z08-H	●	100	8	32	50	3.5					2514-M16x35

R: Sağ / Right / Правый L: Sol/Left/Левый
● Stokta / In Stock / В наличии ○ Stokta Yok / Non Stock Item / Нет в наличии
WLTR Ucuna Uygundur. / Compatible with WLTR Insert. / Под пластину WLTR

Sipariş Örneği/Ordering Example/Образец заказа
1 ad./pcs./шт AFM42C-XD0806-D063-A27-Z04-H

Kesme Hesabı : S 321 / Cutting Calculation : P 321 / Расчет режимов резания: стр. 321

Montaj Ölçüleri : S 318 / Mounting Reference : P 318 / Инструкция по установке фрез: стр. 318

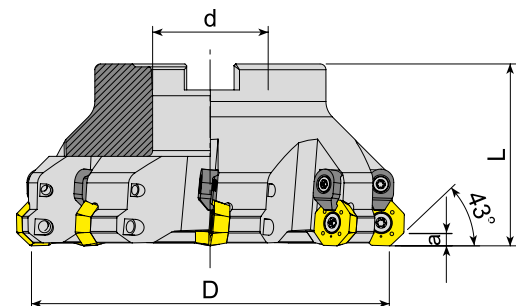

Takım Kodu Ordering Code Код для заказа	Stok Stock Наличие	Takım Ölçüleri (mm) Dimension (mm) Размеры (мм)					Kesici Uç Insert Пластина	Yedek Parçaları / Spare Parts / Запасные части							
		D	Z	d	L	a		Sıkma Vidası Screw Зажимной винт	Baskı Parçası Wedge Clamp Прижим	Baskı Vidası Clamp Screw Зажимной винт	Tork Anahtar Torx Key Торх Ключ	Montaj Vidası Mounting Screw Монтажный винт			
AFM43C-OD0605-D080-A27-Z06-H	●	80	6	27	50	4	OD.. 0605..		ACK-05	4015-M4x11		2510-M12x35			
AFM43C-OD0605-D100-A32-Z07-H	●	100	7	32	50	4						1020-M5x11	4015-M4x11	80-T20	2514-M16x35
AFM43C-OD0605-D125-B40-Z08	●	125	8	40	63	4									-

WLTR-LMN Ucuna Uygundur. / Compatible with WLTR-LMN Insert. / Под пластину WLTR-LMN

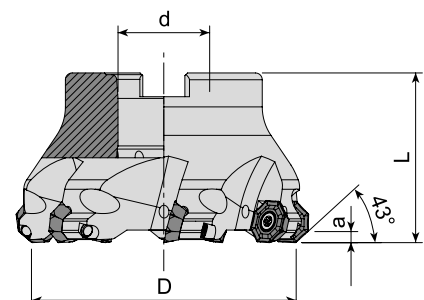

Takım Kodu Ordering Code Код для заказа	Stok Stock Наличие	Takım Ölçüleri (mm) Dimension (mm) Размеры (мм)					Kesici Uç Insert Пластина	Yedek Parçaları / Spare Parts / Запасные части						
		D	Z	d	L	a		Sıkma Vidası Screw Зажимной винт	Tork Anahtar Torx Key Торх Ключ	Montaj Vidası Mounting Screw Монтажный винт				
AFM43-OF05T3-D050-A22-Z05-H	●	50	5	22	40	3	OF.. 05T3..		80-T15		2407-M10x30			
AFM43-OF05T3-D063-A22-Z06-H	●	63	6	22	40	3					4015-M4x9	4015-M4x11	80-T15	2510-M12x35
AFM43-OF05T3-D080-A27-Z07-H	●	80	7	27	50	3								-
AFM43-OF05T3-D125-B40-Z09	●	125	9	40	63	3								-

R: Sağ / Right / Правый L: Sol/Left/Левый

● Stokta / In Stock / В наличии ○ Stokta Yok / Non Stock Item / Нет в наличии
ISO Ucuna Uygundur. / Compatible with ISO Insert. / Под пластину ISO

Sipariş Örneği/Ordering Example/Образец заказа

1 ad./pcs./шт AFM43C-OD0605-D080-A27-Z06-H

Kesme Hesabı : S 321 / Cutting Calculation : P 321 / Расчет режимов резания: стр. 321

Montaj Ölçüleri : S 318 / Mounting Reference : P 318 / Инструкция по установке фрез: стр. 318

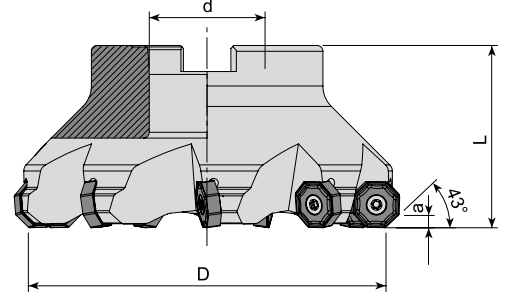

Takım Kodu Ordering Code Код для заказа	Stok Stock Наличие	Takım Ölçüleri (mm) Dimension (mm) Размеры (мм)					Kesici Uç Insert Пластина	Yedek Parçaları / Spare Parts / Запасные части			
		D	Z	d	L	a		Sıkma Vidası Screw Зажимной винт	Tork Anahtar Torx Key Торх Ключ	Montaj Vidası Mounting Screw Монтажный винт	
AFM43-ON0604-D050-A22-Z05-H	●	50	5	22	40	4	ON.. 0604..				2407-M10x30
AFM43-ON0604-D063-A22-Z06-H	●	63	6	22	40	4					
AFM43-ON0604-D080-A27-Z07-H	●	80	7	27	50	4					
AFM43-ON0604-D100-A32-Z08-H	●	100	8	32	50	4					
AFM43-ON0604-D125-B40-Z09	●	125	9	40	63	4					

ZCC Ucuna Uygundur. / Compatible with ZCC Insert. / Под пластину ZCC

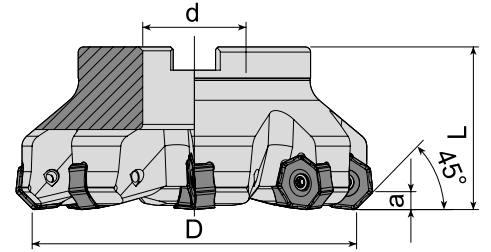

Takım Kodu Ordering Code Код для заказа	Stok Stock Наличие	Takım Ölçüleri (mm) Dimension (mm) Размеры (мм)					Kesici Uç Insert Пластина	Yedek Parçaları / Spare Parts / Запасные части			
		D	Z	d	L	a		Sıkma Vidası Screw Зажимной винт	Tork Anahtar Torx Key Торх Ключ	Montaj Vidası Mounting Screw Монтажный винт	
AFM44-ON0606-D063-A22-Z06-H	●	63	6	22	40	3.8	ONHX 0606..				2407-M10x30
AFM44-ON0606-D080-A27-Z08-H	●	80	8	27	50	3.8					
AFM44-ON0606-D100-A32-Z10-H	●	100	10	32	50	3.8					

R: Sağ / Right / Правый L: Sol/Left/Левый
● Stokta / In Stock / В наличии ○ Stokta Yok / Non Stock Item / Нет в наличии
KRLY Ucuna Uygundur. / Compatible with KRLY Insert. / Под пластину KRLY

Sipariş Örneği/Ordering Example/Образец заказа
1 ad./pcs./шт AFM43-ON0604-D050-A22-Z05-H
Kesme Hesabı : S 321 / Cutting Calculation : P 321 / Расчет режимов резания: стр. 321
Montaj Ölçüleri : S 318 / Mounting Reference : P 318 / Инструкция по установке фрез: стр. 318

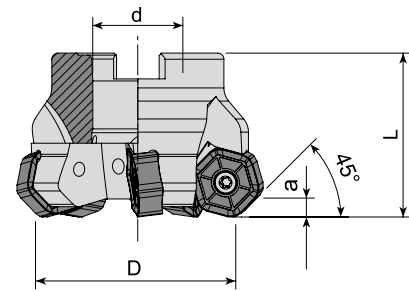

Takım Kodu Ordering Code Код для заказа	Stok Stock Наличие	Takım Ölçüleri (mm) Dimension (mm) Размеры (мм)					Kesici Uç Insert Пластина	Yedek Parçaları / Spare Parts / Запасные части		
		D	Z	d	L	a		Sıkma Vidası Screw Зажимной винт	Tork Anahtar Torx Key Торх Ключ	Montaj Vidası Mounting Screw Монтажный винт
AFM45-HN0905-D050-A22-Z05-H	●	50	5	22	40	4.5	HN.. 0905..	4015-M4x11	80-T15	2407-M10x30
AFM45-HN0905-D063-A22-Z06-H	●	63	6	22	40	4.5				
AFM45-HN0905-D080-A27-Z07-H	●	80	7	27	50	4.5				
AFM45-HN0905-D125-B40-Z10	●	125	10	40	63	4.5				
AFM45-HN0905-D160-C40-Z12	●	160	12	40	63	4.5				
AFM45L-HN0905-D160-C40-Z12	●	160	12	40	63	4.5				
AFM45-HN0905-D200-C60-Z16	●	200	16	60	63	4.5				
AFM45L-HN0905-D200-C60-Z16	●	200	16	60	63	4.5				

WDA Ucuna Uygundur. / Compatible with WDA Insert. / Под пластину WDA

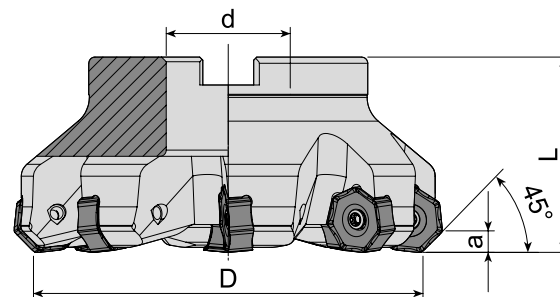

Takım Kodu Ordering Code Код для заказа	Stok Stock Наличие	Takım Ölçüleri (mm) Dimension (mm) Размеры (мм)					Kesici Uç Insert Пластина	Yedek Parçaları / Spare Parts / Запасные части		
		D	Z	d	L	a		Sıkma Vidası Screw Зажимной винт	Tork Anahtar Torx Key Торх Ключ	Montaj Vidası Mounting Screw Монтажный винт
AFM45-NN2007-D100-A32-Z07-H	●	100	7	32	50	6	NNMU 2007..	1020-M5x14	80-T20	2514-M16x35
AFM45-NN2007-D125-B40-Z08	●	125	8	40	63	6				
AFM45-NN2007-D160-C40-Z10	●	160	10	40	63	6				

R: Sağ / Right / Правый L: Sol/Left/Левый

● Stokta / In Stock / В наличии ○ Stokta Yok / Non Stock Item / Нет в наличии

MTSBSH Ucuna Uygundur. / Compatible with MTSBSH Insert. / Под пластину MTSBSH

Sipariş Örneği/Ordering Example/Образец заказа

1 ad./pcs./шт AFM45-HN0905-D063-A22-Z06-H

Kesme Hesabı : S 321 / Cutting Calculation : P 321 / Расчет режимов резания: стр. 321

Montaj Ölçüleri : S 318 / Mounting Reference : P 318 / Инструкция по установке фрез: стр. 318

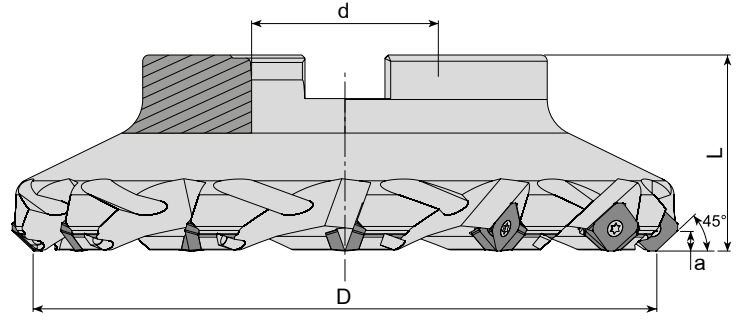

Takım Kodu Ordering Code Код для заказа	Stok Stock Наличие	Takım Ölçüleri (mm) Dimension (mm) Размеры (мм)					Kesici Uç Insert Пластина	Yedek Parçaları / Spare Parts / Запасные части			
		D	Z	d	L	a		Sıkma Vidası Screw Зажимной винт	Tork Anahtar Torx Key Торх Ключ	Montaj Vidası Mounting Screw Монтажный винт	
AFM45-SE12-D050-A22-Z04-H	●	50	4	22	40	6	SE.. 12T3.. R245-12T3..	4015-M3.5x11	80-T15	2407-M10x30	
AFM45L-SE12-D050-A22-Z04-H	●	50	4	22	40	6					
AFM45-SE12-D063-A22-Z05-H	●	63	5	22	40	6					
AFM45L-SE12-D063-A22-Z05-H	●	63	5	22	40	6					
AFM45-SE12-D080-A27-Z06-H	●	80	6	27	50	6					
AFM45L-SE12-D080-A27-Z06-H	●	80	6	27	50	6					
AFM45-SE12-D100-A32-Z07-H	●	100	7	32	50	6					
AFM45-SE12-D125-B40-Z08	●	125	8	40	63	6					
AFM45-SE12-D160-C40-Z10	●	160	10	40	63	6					
AFM45L-SE12-D160-C40-Z10	●	160	10	40	63	6					
AFM45-SE12-D200-C60-Z12	●	200	12	60	63	6	-	-	-		

ZCC-SNDVK Ucuna Uygunudur. / Compatible with ZCC-SNDVK Insert. / Под пластину ZCC-SNDVK

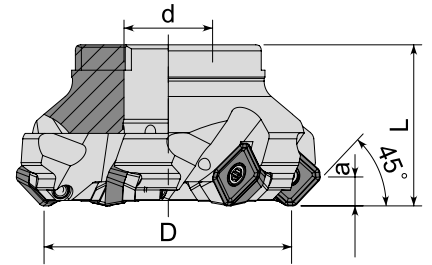

Takım Kodu Ordering Code Код для заказа	Stok Stock Наличие	Takım Ölçüleri (mm) Dimension (mm) Размеры (мм)					Kesici Uç Insert Пластина	Yedek Parçaları / Spare Parts / Запасные части										
		D	Z	d	L	a		Altık Screw Опорная пластина	Altık Vidası Wedge Clamp Винт опорной пластины	Sıkma Vidası Screw Зажимной винт	Tork Anahtar Torx Key Торх Ключ	Montaj Vidası Mounting Screw Монтажный винт						
AFM45-SE13-D050-A22-Z04-H	●	50	4	22	40	6	SEMT 13T3..	AASE-3-0001	AAV-16-M3.5x8	4015-M3.5x12	80-T15	2407-M10x30						
AFM45-SE13-D063-A22-Z05-H	●	63	5	22	40	6												
AFM45-SE13-D080-A27-Z06-H	●	80	6	27	50	6												
AFM45S-SE13-D050-A22-Z05-H	●	50	5	22	40	6												
AFM45S-SE13-D063-A22-Z06-H	●	63	6	22	40	6												
AFM45S-SE13-D080-A27-Z08-H	●	80	8	27	50	6												
AFM45S-SE13-D100-A32-Z10-H	●	100	10	32	50	6												
AFM45S-SE13-D125-B40-Z12	●	125	12	40	63	6												
-	-	-	-	-	-	-							-	-	-	-	-	-

R: Sağ / Right / Правый L: Sol/Left/Левый

● Stokta / In Stock / В наличии ○ Stokta Yok / Non Stock Item / Нет в наличии

SMTM-DJT Ucuna Uygunudur. / Compatible with SMTM-DJT Insert. / Под пластину SMTM-DJT

Sipariş Örneği/Ordering Example/Образец заказа

1 ad./pcs./шт AFM45-SE12-D050-A22-Z04-H

Kesme Hesabı : S 321 / Cutting Calculation : P 321 / Расчет режимов резания: стр. 321

Montaj Ölçüleri : S 318 / Mounting Reference : P 318 / Инструкция по установке фрез: стр. 318

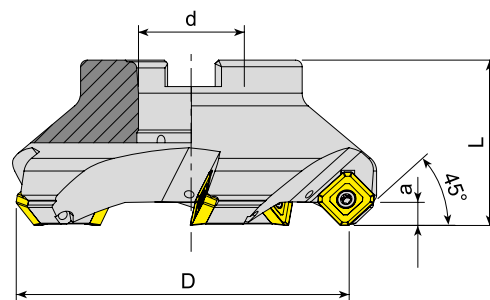

Takım Kodu Ordering Code Код для заказа	Stok Stock Наличие	Takım Ölçüleri (mm) Dimension (mm) Размеры (мм)					Kesici Uç Insert Пластина	Yedek Parçaları / Spare Parts / Запасные части			
		D	Z	d	L	a		Sikma Vidası Screw Зажимной винт	Tork Anahtar Torx Key Торх Ключ	Montaj Vidası Mounting Screw Монтажный винт	
AFM45-SE14M4-D063-A22-Z04-H	●	63	4	22	40	7	SE.. 14M4..	4015-M3.5x11	80-T15	2407-M10x30 2510-M12x35 2514-M16x35	
AFM45-SE14M4-D080-A27-Z05-H	●	80	5	27	50	7					
AFM45-SE14M4-D100-A32-Z05-H	●	100	5	32	50	7					
AFM45-SE14M4-D125-B40-Z06	●	125	6	40	63	7					
AFM45-SE14M4-D160-C40-Z07	●	160	7	40	63	7					

KRLY Ucuna Uygundur. / Compatible with KRLY Insert. / Под пластину KRLY

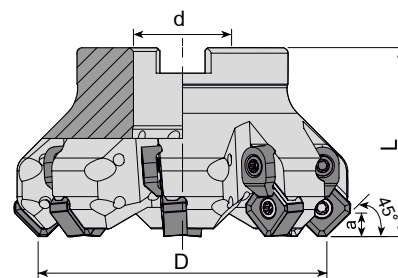

Takım Kodu Ordering Code Код для заказа	Stok Stock Наличие	Takım Ölçüleri (mm) Dimension (mm) Размеры (мм)					Kesici Uç Insert Пластина	Yedek Parçaları / Spare Parts / Запасные части				
		D	Z	d	L	a		Sikma Vidası Screw Зажимной винт	Baskı Parçası Wedge Clamp Прижим	Baskı Vidası Clamp Screw Зажимной винт	Tork Anahtar Torx Key Торх Ключ	Montaj Vidası Mounting Screw Монтажный винт
AFM45C-SN12..-D050-A22-Z04-H	●	50	4	22	42	6	SN.. 12..	1015-M4x11	ACK-05	4015-M4x11	80-T15	2407-M10X30 2510-M12x35 2514-M16x35
AFM45C-SN12..-D050-A22-Z05-H	●	50	5	22	42	6						
AFM45C-SN12..-D063-A22-Z06-H	●	63	6	22	42	6						
AFM45C-SN12..-D063-A22-Z07-H	●	63	7	22	42	6						
AFM45CL-SN12..-D063-A22-Z07-H	●	63	7	22	42	6						
AFM45C-SN12..-D080-A27-Z07-H	●	80	7	27	52	6						
AFM45C-SN12..-D080-A27-Z08-H	●	80	8	27	52	6						
AFM45CL-SN12..-D080-A27-Z08-H	●	80	8	27	52	6						
AFM45C-SN12..-D100-A32-Z08-H	●	100	8	32	52	6						
AFM45C-SN12..-D100-A32-Z10-H	●	100	10	32	52	6						
AFM45CL-SN12..-D100-A32-Z10-H	●	100	10	32	52	6						
AFM45C-SN12..-D125-B40-Z11	●	125	11	40	65	6						
AFM45CL-SN12..-D125-B40-Z11	●	125	11	40	65	6						
AFM45C-SN12..-D160-C40-Z12	●	160	12	40	65	6						
AFM45C-SN12..-D200-C60-Z14	●	200	14	60	65	6						
AFM45CL-SN12..-D200-C60-Z14	●	200	14	60	65	6						

R: Sağ / Right / Правый L: Sol/Left/Левый

● Stokta / In Stock / В наличии ○ Stokta Yok / Non Stock Item / Нет в наличии

WLTR-LMN-ACHTK Ucuna Uygundur. / Compatible with WLTR-LMN-ACHTK Insert. / Под пластину WLTR-LMN-ACHTK

Montaj Ölçüleri : S 318 / Mounting Reference : P 318 / Инструкция по установке фрез: стр. 318

Sipariş Örneği/Ordering Example/Образец заказа

1 ad./pcs./шт AFM45-SE14M4-D063-A22-Z04-H

Kesme Hesabı : S 321 / Cutting Calculation : P 321 / Расчет режимов резания: стр. 321

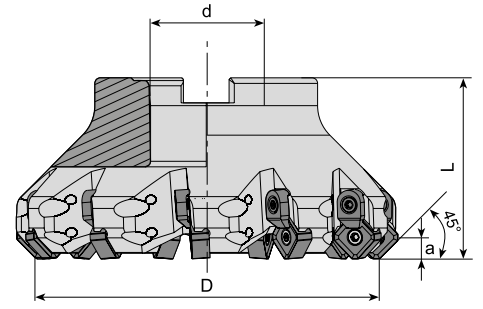

Takım Kodu Ordering Code Код для заказа	Stok Stock Наличие	Takım Ölçüleri (mm) Dimension (mm) Размеры (мм)					Kesici Uç Insert Пластина	Yedek Parçaları / Spare Parts / Запасные части					
		D	Z	d	L	a		Sıkma Vidası Screw Зажимной винт	Baskı Parçası Wedge Clamp Прижим	Baskı Vidası Clamp Screw Зажимной винт	Tork Anahtar Torx Key Торх Ключ	Montaj Vidası Mounting Screw Монтажный винт	
AFM45C-SN1206-D050-A22-Z04-H	●	50	4	22	42	6	SN.. 1206..						
AFM45CL-SN1206-D050-A22-Z05-H	●	50	5	22	42	6							
AFM45C-SN1206-D050-A22-Z05-H	●	50	5	22	42	6							
AFM45C-SN1206-D063-A22-Z06-H	●	63	6	22	42	6							2407-M10x30
AFM45C-SN1206-D063-A22-Z07-H	●	63	7	22	42	6							
AFM45CL-SN1206-D063-A22-Z07-H	●	63	7	22	42	6							
AFM45C-SN1206-D080-A27-Z07-H	●	80	7	27	52	6							
AFM45C-SN1206-D080-A27-Z08-H	●	80	8	27	52	6							2510-M12x35
AFM45CL-SN1206-D080-A27-Z08-H	●	80	8	27	52	6							
AFM45C-SN1206-D100-A32-Z08-H	●	100	8	32	52	6							
AFM45C-SN1206-D100-A32-Z10-H	●	100	10	32	52	6							2514-M16x35
AFM45CL-SN1206-D100-A32-Z10-H	●	100	10	32	52	6							
AFM45C-SN1206-D125-B40-Z11	●	125	11	40	65	6							
AFM45CL-SN1206-D125-B40-Z11	●	125	11	40	65	6							
AFM45C-SN1206-D160-C40-Z12	●	160	12	40	65	6							
AFM45C-SN1206-D200-C60-Z14	●	200	14	60	65	6							
AFM45CL-SN1206-D200-C60-Z14	●	200	14	60	65	6							

KRLY-PLBT-BHLR Ucuna Uygundur. / Compatible with KRLY-PLBT-BHLR Insert. / Под пластину KRLY-PLBT-BHLR

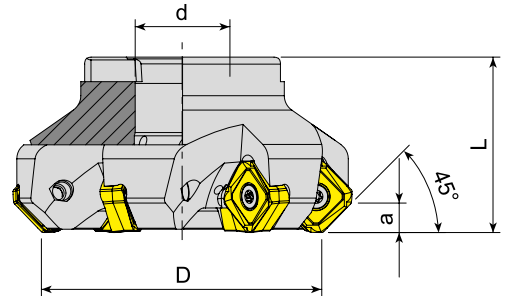

Takım Kodu Ordering Code Код для заказа	Stok Stock Наличие	Takım Ölçüleri (mm) Dimension (mm) Размеры (мм)					Kesici Uç Insert Пластина	Yedek Parçaları / Spare Parts / Запасные части							
		D	Z	d	L	a		Sıkma Vidası Screw Зажимной винт	Tork Anahtar Torx Key Торх Ключ	Montaj Vidası Mounting Screw Монтажный винт					
AFM45-SA1706-D080-A27-Z06-H	●	80	6	27	50	8.4	SAKU 1706..								
AFM45-SA1706-D100-A32-Z07-H	●	100	7	32	50	8.4							1020-M5x14	80-T20	2510-M12x35
AFM45-SA1706-D125-B40-Z09	●	125	9	40	63	8.4									2514-M16x35

R: Sağ / Right / Правый L: Sol/Left/Левый

● Stokta / In Stock / В наличии ○ Stokta Yok / Non Stock Item / Нет в наличии

CRTZT Ucuna Uygundur. / Compatible with CRTZT Insert. / Под пластину CRTZT

Sipariş Örneği/Ordering Example/Образец заказа

1 ad./pcs./шт AFM45C-SN1206-D050-A22-Z04-H

Kesme Hesabı : S 321 / Cutting Calculation : P 321 / Расчет режимов резания: стр. 312

Montaj Ölçüleri : S 318 / Mounting Reference : P 318 / Инструкция по установке фрез: стр. 318

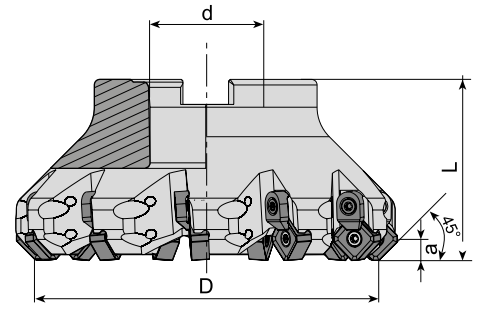

Takım Kodu Ordering Code Код для заказа	Stok Stock Наличие	Takım Ölçüleri (mm) Dimension (mm) Размеры (мм)					Kesici Uç Insert Пластина	Yedek Parçaları / Spare Parts / Запасные части					
		D	Z	d	L	a		Sıkma Vidası Screw Зажимной винт	Baskı Parçası Wedge Clamp Прижим	Baskı Vidası Clamp Screw Зажимной винт	Tork Anahtar Torx Key Торх Ключ	Montaj Vidası Mounting Screw Монтажный винт	
AFM45C-SN12Z-D050-A22-Z05-H	●	50	5	22	42	6	SNEG 1205..						2407-M10X30
AFM45C-SN12Z-D063-A22-Z06-H	●	63	6	22	42	6							2510-M12x35
AFM45C-SN12Z-D080-A27-Z07-H	●	80	7	27	52	6							2514-M16x35
AFM45C-SN12Z-D100-A32-Z09-H	●	100	9	32	52	6							-
AFM45C-SN12Z-D125-B40-Z11	●	125	11	40	65	6							-
AFM45C-SN12Z-D160-C40-Z12	●	160	12	60	65	6							-
AFM45C-SN12Z-D200-C60-Z14	●	200	14	60	65	6							-

ZCC Ucuna Uygundur. / Compatiple with ZCC Insert. / Под пластину ZCC

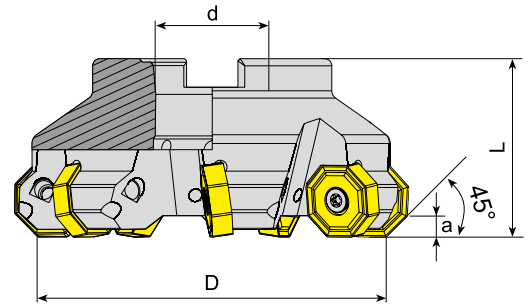

Takım Kodu Ordering Code Код для заказа	Stok Stock Наличие	Takım Ölçüleri (mm) Dimension (mm) Размеры (мм)					Kesici Uç Insert Пластина	Yedek Parçaları / Spare Parts / Запасные части					
		D	Z	d	L	a		Sıkma Vidası Screw Зажимной винт	Tork Anahtar Torx Key Торх Ключ	Montaj Vidası Mounting Screw Монтажный винт			
AFM45-ON0806-D063-A22-Z05-H	●	63	5	22	40	4	ON.. 0806..						2508-M10x30
AFM45-ON0806-D080-A27-Z06-H	●	80	6	27	50	4							2510-M12x35
AFM45-ON0806-D100-A32-Z07-H	●	100	7	32	50	4							2514-M16x35
AFM45-ON0806-D125-B40-Z08	●	125	8	40	63	4							-
AFM45-ON0806-D160-C40-Z10	●	160	10	40	63	4							-
AFM45-ON0806-D200-C60-Z12	●	200	12	60	63	4							-
AFM45-ON0806-D315-D60-Z16	●	315	16	60	63	4							-

R: Sağ / Right / Правый L: Sol/Left/Левый
● Stokta / In Stock / В наличии ○ Stokta Yok / Non Stock Item / Нет в наличии
ISO Ucuna Uygundur. / Compatiple with ISO Insert. / Под пластину ISO

Sipariş Örneği/Ordering Example/Образец заказа
1 ad./pcs./шт AFM45C-SN12Z-D050-A22-Z05-H
Kesme Hesabı : S 321 / Cutting Calculation : P 321 / Расчет режимов резания: стр. 321
Montaj Ölçüleri : S 318 / Mounting Reference : P 318 / Инструкция по установке фрез: стр. 318



45°

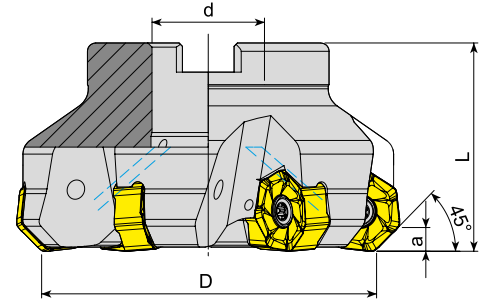

Takım Kodu Ordering Code Код для заказа	Stok Stock Наличие	Takım Ölçüleri (mm) Dimension (mm) Размеры (мм)					Kesici Uç Insert Пластина	Yedek Parçaları / Spare Parts / Запасные части				
		D	Z	d	L	a		Sıkma Vidası Screw Зажимной винт	Baskı Parçası Wedge Clamp Прижим	Baskı Vidası Clamp Screw Зажимной винт	Tork Anahtar Torx Key Торх Ключ	Montaj Vidası Mounting Screw Монтажный винт
AFM45-XN0906-D063-A22-Z06-H	●	63	6	22	50	5	XNMU 0906..	1120-M5x13	-	-	80-T20	2407-M10x30
AFM45-XN0906-D080-A27-Z06-H	●	80	6	27	50	5						2510-M12x35
AFM45-XN0906-D100-A32-Z07-H	●	100	7	32	55	5						2514-M16x35
AFM45-XN0906-D125-B40-Z08	●	125	8	40	63	5						-

TGTC Ucuna Uygundur. / Compatible with TGTC Insert. / Под пластину TGTC



66°

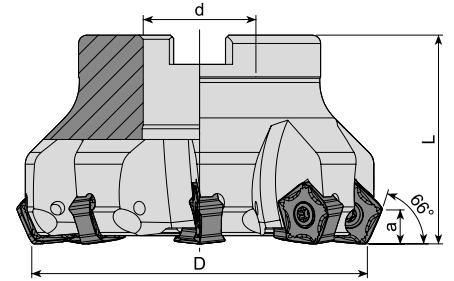

Takım Kodu Ordering Code Код для заказа	Stok Stock Наличие	Takım Ölçüleri (mm) Dimension (mm) Размеры (мм)					Kesici Uç Insert Пластина	Yedek Parçaları / Spare Parts / Запасные части			
		D	Z	d	L	a		Sıkma Vidası Screw Зажимной винт	Tork Anahtar Torx Key Торх Ключ	Montaj Vidası Mounting Screw Монтажный винт	
AFM66-PN0905-D050-A22-Z05	●	50	5	22	40	8	PNMU 0905..	4015-M4x11	80-T15	-	2508-M10x30
AFM66-PN0905-D063-A22-Z06	●	63	6	22	40	8					2510-M12x35
AFM66-PN0905-D080-A27-Z08	●	80	8	27	50	8					2514-M16x35
AFM66-PN0905-D100-A32-Z10	●	100	10	32	50	8					-
AFM66-PN0905-D125-B40-Z12	●	125	12	40	63	8					-

R: Sağ / Right / Правый L: Sol/Left/Левый

● Stokta / In Stock / В наличии ○ Stokta Yok / Non Stock Item / Нет в наличии

KYCR Ucuna Uygundur. / Compatible with KYCR Insert. / Под пластину KYCR

Sipariş Örneği/Ordering Example/Образец заказа

1 ad./pcs./шт AFM45-XN0906-D063-A22-Z06-H

Kesme Hesabı : S 321 / Cutting Calculation : P 321 / Расчет режимов резания: стр. 321

Montaj Ölçüleri : S 318 / Mounting Reference : P 318 / Инструкция по установке фрез: стр. 318

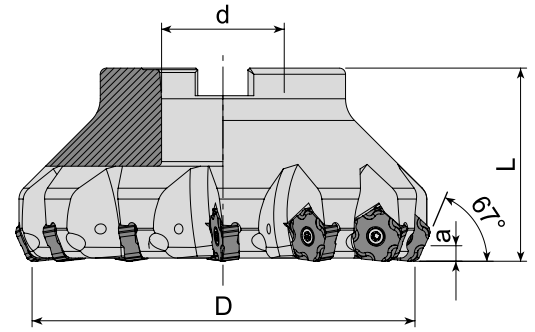

Takım Kodu Ordering Code Код для заказа	Stok Stock Наличие	Takım Ölçüleri (mm) Dimension (mm) Размеры (мм)					Kesici Uç Insert Пластина	Yedek Parçaları / Spare Parts / Запасные части		
		D	Z	d	L	a		Sıkma Vidası Screw Зажимной винт	Tork Anahtar Torx Key Торх Ключ	Montaj Vidası Mounting Screw Монтажный винт
AFM67-PN1105-D050-A22-Z05	●	50	5	22	50	5	PNEG 1105..	4015-M4x11	80-T15	2508-M10x30
AFM67-PN1105-D063-A22-Z06	●	63	6	22	50	5				
AFM67-PN1105-D080-A27-Z08	●	80	8	27	50	5				
AFM67-PN1105-D100-B32-Z10	●	100	10	32	50	5				
AFM67-PN1105-D125-B40-Z12	●	125	12	40	63	5				
AFM67-PN1105-D160-C40-Z14	●	160	14	40	63	5				

ZCC Ucuna Uygundur. / Compatible with ZCC Insert. / Под пластину ZCC

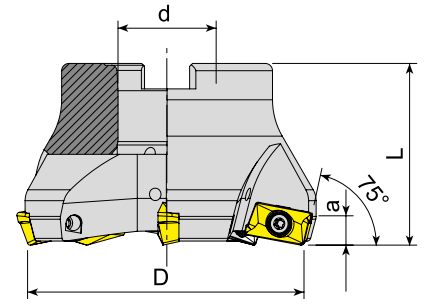

Takım Kodu Ordering Code Код для заказа	Stok Stock Наличие	Takım Ölçüleri (mm) Dimension (mm) Размеры (мм)					Kesici Uç Insert Пластина	Yedek Parçaları / Spare Parts / Запасные части		
		D	Z	d	L	a		Sıkma Vidası Screw Зажимной винт	Tork Anahtar Torx Key Торх Ключ	Montaj Vidası Mounting Screw Монтажный винт
AFM75-AP16-D063-A22-Z04-H	●	63	4	22	40	6	AP.. 1604..	4015-M4x11	80-T15	2508-M10x30
AFM75-AP16-D080-A27-Z05-H	●	80	5	27	50	6				2510-M12x35
AFM75-AP16-D100-A32-Z06-H	●	100	6	32	50	6				2514-M16x35
AFM75-AP16-D125-B40-Z07	●	125	7	40	63	6				-

R: Sağ / Right / Правый L: Sol/Left/Левый

● Stokta / In Stock / В наличии ○ Stokta Yok / Non Stock Item / Нет в наличии

ISO Ucuna Uygundur. / Compatible with ISO Insert. / Под пластину ISO

Sipariş Örneği/Ordering Example/Образец заказа

1 ad./pcs./шт AFM67-PN1105-D050-A22-Z05

Kesme Hesabı : S 321 / Cutting Calculation : P 321 / Расчет режимов резания: стр. 321

Montaj Ölçüleri : S 318 / Mounting Reference : P 318 / Инструкция по установке фрез: стр. 318

75°

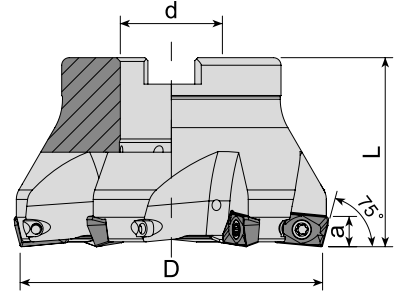

Takım Kodu Ordering Code Код для заказа	Stok Stock Наличие	Takım Ölçüleri (mm) Dimension (mm) Размеры (мм)					Kesici Uç Insert Пластина	Yedek Parçaları / Spare Parts / Запасные части				
		D	Z	d	L	a		Sıkma Vidası Screw Зажимной винт	Tork Anahtar Torx Key Торкс Ключ	Montaj Vidası Mounting Screw Монтажный винт		
AFM75-X012-D050-A22-Z04-H	●	50	4	22	40	-	XOMX 1204..		80-T10			
AFM75-X012-D063-A22-Z05-H	●	63	5	22	40	-					3010-M3.5x9	2508-M10x30
AFM75-X012-D080-A27-Z06-H	●	80	6	27	50	-						

SC Ucuna Uygun. / Compatible with SC Insert. / Под пластину SC



88°

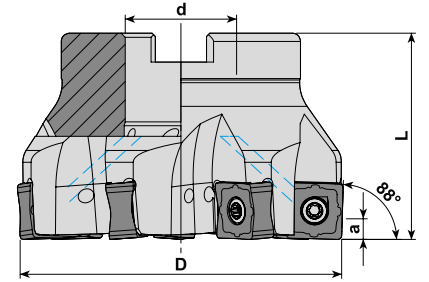

Takım Kodu Ordering Code Код для заказа	Stok Stock Наличие	Takım Ölçüleri (mm) Dimension (mm) Размеры (мм)					Kesici Uç Insert Пластина	Yedek Parçaları / Spare Parts / Запасные части				
		D	Z	d	L	a		Sıkma Vidası Screw Зажимной винт	Tork Anahtar Torx Key Торкс Ключ	Montaj Vidası Mounting Screw Монтажный винт		
AFM88-SN1305-D050-A22-Z04	●	50	4	22	40	5	SNMU 1305..		80-T15	2508-M10x30		
AFM88-SN1305-D050-A22-Z05	●	50	5	22	40	5					4015-M4x11	2510-M12x35
AFM88-SN1305-D063-A22-Z05	●	63	5	22	40	5						
AFM88-SN1305-D063-A22-Z07	●	63	7	22	40	5						
AFM88-SN1305-D080-A27-Z06	●	80	6	27	50	5						
AFM88-SN1305-D080-A27-Z09	●	80	9	27	50	5						
AFM88-SN1305-D100-A32-Z07	●	100	7	32	50	5						
AFM88-SN1305-D100-A32-Z11	●	100	11	32	50	5						
AFM88-SN1305-D125-B40-Z13	●	125	13	40	63	5				-		

R: Sağ / Right / Правый L: Sol/Left/Левый

● Stokta / In Stock / В наличии ○ Stokta Yok / Non Stock Item / Нет в наличии

KYCR Ucuna Uygun. / Compatible with KYCR Insert. / Под пластину KYCR

Sipariş Örneği/Ordering Example/Образец заказа

1 ad./pcs./шт AFM75-X012-D050-A22-Z04-H

Kesme Hesabı : S 321 / Cutting Calculation : P 321 / Расчет режимов резания: стр. 321

Montaj Ölçüleri : S 318 / Mounting Reference : P 318 / Инструкция по установке фрез: стр. 318



88°

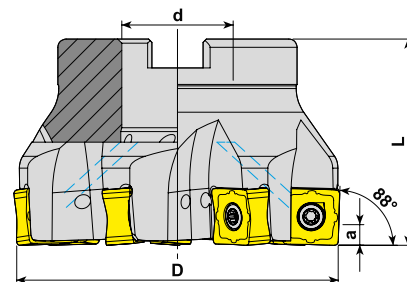

Takım Kodu
Ordering Code
Код для заказа

Stok
Stock
Наличие

Takım Ölçüleri (mm)
Dimension (mm)
Размеры (мм)

Kesici Uç
Insert
Пластина

Yedek Parçaları / Spare Parts / Запасные части

Sıkma Vidası
Screw
Зажимной винт

Tork Anahtar
Torx Key
Торх Ключ

Montaj Vidası
Mounting Screw
Монтажный винт

D Z d L a

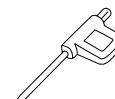

AFM88-SN1306-D050-A22-Z05-H



50

5

22

40

5

AFM88-SN1306-D063-A22-Z06-H



63

6

22

40

5

AFM88-SN1306-D080-A27-Z07-H



80

7

27

50

5

SNGX 1306..

1115-M4x10

80-T15

2508-M10x30

2510-M12x35

TGTC Ucuna Uygunudur. / Compatible with TGTC Insert. / Под пластину TGTC

88°

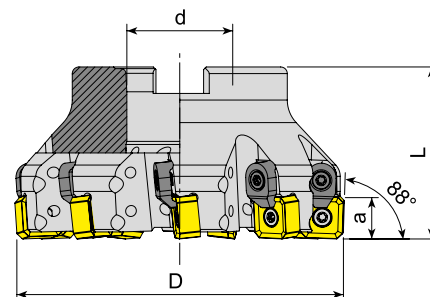

Takım Kodu
Ordering Code
Код для заказа

Stok
Stock
Наличие

Takım Ölçüleri (mm)
Dimension (mm)
Размеры (мм)

Kesici Uç
Insert
Пластина

Sıkma Vidası
Screw
Зажимной винт

Baskı Parçası
Wedge Clamp
Прижим

Baskı Vidası
Clamp Screw
Зажимной винт

Tork Anahtar
Torx Key
Торх Ключ

Montaj Vidası
Mounting Screw
Монтажный винт

D Z d L a



AFM88C-SN1206-D063-A22-Z06-H



63

6

22

40

11.5

AFM88C-SN1206-D080-A27-Z07-H



80

7

27

50

11.5

AFM88C-SN1206-D100-A32-Z09-H



100

9

32

52

11.5

SN.. 1206..

4615-M4x11

ACK-05

4015-M4x11

80-T15

2508-M10x30

2510-M12x35

2514-M16x35

R: Sağ / Right / Правый L: Sol/Left/Левый

● Stokta / In Stock / В наличии ○ Stokta Yok / Non Stock Item / Нет в наличии

ISO Ucuna Uygunudur. / Compatible with ISO Insert. / Под пластину ISO

Sipariş Örneği/Ordering Example/Образец заказа

1 ad./pcs./шт AFM88-SN1306-D050-A22-Z05-H

Kesme Hesabı : S 321 / Cutting Calculation : P 321 / Расчет режимов резания: стр. 321

Montaj Ölçüleri : S 318 / Mounting Reference : P 318 / Инструкция по установке фрез: стр. 318

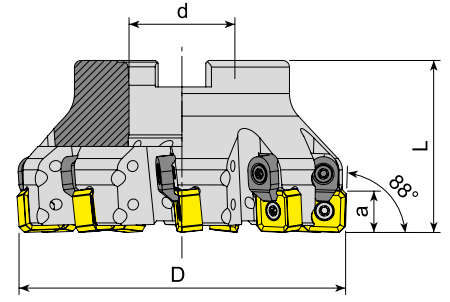

Takım Kodu Ordering Code Код для заказа	Stok Stock Наличие	Takım Ölçüleri (mm) Dimension (mm) Размеры (мм)					Kesici Uç Insert Пластина	Yedek Parçaları / Spare Parts / Запасные части				
		D	Z	d	L	a		Sıkma Vidası Screw Зажимной винт	Baskı Parçası Wedge Clamp Прижим	Baskı Vidası Clamp Screw Зажимной винт	Tork Anahtar Torx Key Торх Ключ	Montaj Vidası Mounting Screw Монтажный винт
AFM88C-SN12..-D063-A22-Z06-H	●	63	6	22	40	11.5	SN.. 12..	1015-M4x11	ACK-05	4015-M4x11	80-T15	2508-M10x30
AFM88C-SN12..-D080-A27-Z07-H	●	80	7	27	50	11.5						2510-M12x35
AFM88C-SN12..-D100-A32-Z09-H	●	100	9	32	52	11.5						2514-M16x35

ISO Ucuna Uygundur. / Compatible with ISO Insert. / Под пластину ISO

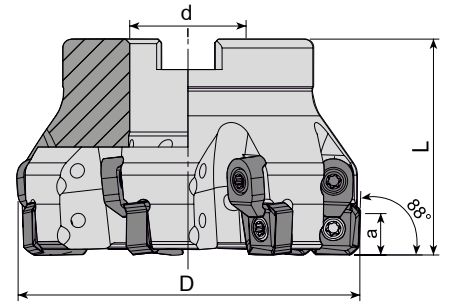

Takım Kodu Ordering Code Код для заказа	Stok Stock Наличие	Takım Ölçüleri (mm) Dimension (mm) Размеры (мм)					Kesici Uç Insert Пластина	Yedek Parçaları / Spare Parts / Запасные части				
		D	Z	d	L	a		Sıkma Vidası Screw Зажимной винт	Baskı Parçası Wedge Clamp Прижим	Baskı Vidası Clamp Screw Зажимной винт	Tork Anahtar Torx Key Торх Ключ	Montaj Vidası Mounting Screw Монтажный винт
AFM88C-SN12Z-D063-A22-Z06-H	●	63	6	22	40	11.5	SNEG 1205..	4015-M4x11	ACK-05	4015-M4x11	80-T15	2508-M10x30
AFM88C-SN12Z-D080-A27-Z07-H	●	80	7	27	50	11.5						2510-M12x35

R: Sağ / Right / Правый L: Sol/Left/ Левый
● Stokta / In Stock / В наличии ○ Stokta Yok / Non Stock Item / Нет в наличии
ZCC Ucuna Uygundur. / Compatible with ZCC Insert. / Под пластину ZCC





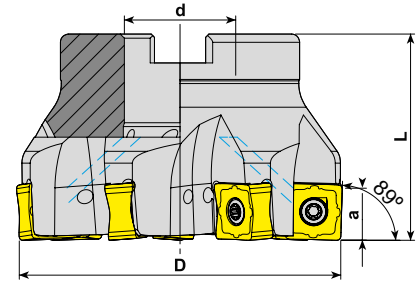

Sipariş Örneği/Ordering Example/Образец заказа
1 ad./pcs./шт AFM88C-SN12..-D063-A22-Z06-H
Kesme Hesabı : S 321 / Cutting Calculation : P 321 / Расчет режимов резания: стр. 321
Montaj Ölçüleri : S 318 / Mounting Reference : P 318 / Инструкция по установке фрез: стр. 318



89°

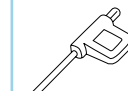

Yedek Parçaları / Spare Parts / Запасные части



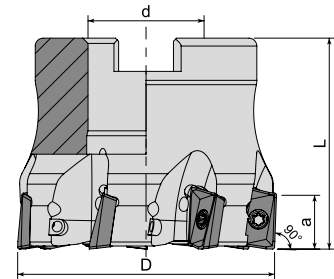

Takım Kodu Ordering Code Код для заказа	Stok Stock Наличие	Takım Ölçüleri (mm) Dimension (mm) Размеры (мм)					Kesici Uç Insert Пластина	Sıkma Vidası Screw Зажимной винт	Baskı Parçası Wedge Clamp Прижим	Baskı Vidası Clamp Screw Зажимной винт	Tork Anahtar Torx Key Торх Ключ	Montaj Vidası Mounting Screw Монтажный винт
		D	Z	d	L	a						
AFM89-SN1305I-D040-A16-Z04-H	●	40	4	16	40	10	 SNMU 1305..  1015 M4x11  -  -  80-T15  2306-M8x37					
AFM89-SN1305I-D050-A22-Z05-H	●	50	5	22	40	10						
AFM89-SN1305I-D063-A22-Z06-H	●	63	6	22	40	10						
AFM89-SN1305I-D063-A22-Z07-H	●	63	7	22	40	10						
AFM89-SN1305I-D080-A27-Z08-H	●	80	8	27	50	10						
AFM89-SN1305I-D100-A32-Z10-H	●	100	10	32	50	10						

ISCR Ucuna Uygundur. / Compatible with ISCR Insert. / Под пластину ISCR

90°



Yedek Parçaları / Spare Parts / Запасные части

Takım Kodu Ordering Code Код для заказа	Stok Stock Наличие	Takım Ölçüleri (mm) Dimension (mm) Размеры (мм)					Kesici Uç Insert Пластина	Sıkma Vidası Screw Зажимной винт	Tork Anahtar Torx Key Торх Ключ	Montaj Vidası Mounting Screw Монтажный винт
		D	Z	d	L	a				
AFM90-AD10T3-D040-A16-Z06-H	●	40	6	16	40	10	 ADMT 10T3..  3008-M2.5x6  80-T08  2506-M8x30			
AFM90-AD10T3-D050-A22-Z07-H	●	50	7	22	40	10				

R: Sağ / Right / Правый L: Sol/Left/Левый

● Stokta / In Stock / В наличии ○ Stokta Yok / Non Stock Item / Нет в наличии

WLTR Ucuna Uygundur. / Compatible with WLTR Insert. / Под пластину WLTR

Sipariş Örneği/Ordering Example/Образец заказа

1 ad./pcs./шт AFM89-SN1305I-D040-A16-Z04-H

Kesme Hesabı : S 321 / Cutting Calculation : P 321 / Расчет режимов резания: стр. 321

Montaj Ölçüleri : S 318 / Mounting Reference : P 318 / Инструкция по установке фрез: стр. 318

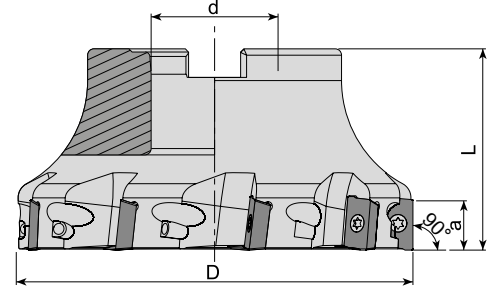

Takım Kodu Ordering Code Код для заказа	Stok Stock Наличие	Takım Ölçüleri (mm) Dimension (mm) Размеры (мм)					Kesici Uç Insert Пластина	Yedek Parçaları / Spare Parts / Запасные части			
		D	Z	d	L	a		Sıkma Vidası Screw Зажимной винт	Tork Anahtar Torx Key Торх Ключ	Montaj Vidası Mounting Screw Монтажный винт	
AFM90-AD1505-D040-A16-Z04-H	●	40	4	16	40	15	AD.. 1505..	4015-M4x11	80-T15	2506-M8x30	
AFM90-AD1505-D050-A22-Z05-H	●	50	5	22	40	15				2508-M10x30	
AFM90-AD1505-D063-A22-Z06-H	●	63	6	22	40	15				2510-M12x35	
AFM90-AD1505-D080-A27-Z07-H	●	80	7	27	50	15				2514-M16x35	
AFM90-AD1505-D100-A32-Z08-H	●	100	8	32	50	15				-	
AFM90-AD1505-D125-B40-Z09	●	125	9	40	63	15				-	

ISO Ucuna Uygundur. / Compatible with ISO Insert. / Под пластину ISO

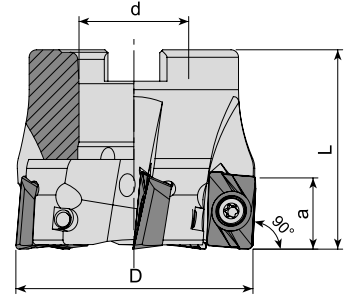

Takım Kodu Ordering Code Код для заказа	Stok Stock Наличие	Takım Ölçüleri (mm) Dimension (mm) Размеры (мм)					Kesici Uç Insert Пластина	Yedek Parçaları / Spare Parts / Запасные части			
		D	Z	d	L	a		Sıkma Vidası Screw Зажимной винт	Tork Anahtar Torx Key Торх Ключ	Montaj Vidası Mounting Screw Монтажный винт	
AFM90-AD1505D-D050-A22-Z05-H	●	50	5	22	40	14.3	ADKT 150508	4015-M4x11	80-T15	2508-M10x30	
AFM90-AD1505D-D063-A27-Z06-H	●	63	6	27	50	14.3				2510-M12x35	
AFM90-AD1505D-D080-A27-Z08-H	●	80	8	27	50	14.3				2514-M16x35	
AFM90-AD1505D-D100-A32-Z08-H	●	100	8	32	50	14.3				-	
AFM90-AD1505D-D125-B40-Z09	●	125	9	40	63	14.3				-	

R: Sağ / Right / Правый L: Sol/Left/Левый
● Stokta / In Stock / В наличии ○ Stokta Yok / Non Stock Item / Нет в наличии
DJT Ucuna Uygundur. / Compatible with DJT Insert. / Под пластину DJT

Sipariş Örneği/Ordering Example/Образец заказа
1 ad./pcs./шт AFM90-AD1505-D040-A16-Z04-H

Kesme Hesabı : S 321 / Cutting Calculation : P 321 / Расчет режимов резания: стр. 321
Montaj Ölçüleri : S 318 / Mounting Reference : P 318 / Инструкция по установке фрез: стр. 318

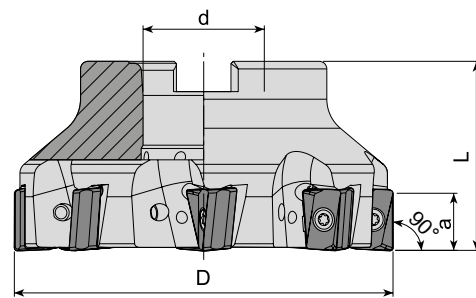

Takım Kodu Ordering Code Код для заказа	Stok Stock Наличие	Takım Ölçüleri (mm) Dimension (mm) Размеры (мм)					Kesici Uç Insert Пластина	Yedek Parçaları / Spare Parts / Запасные части		
		D	Z	d	L	a		Sıkma Vidası Screw Зажимной винт	Tork Anahtar Torx Key Торх Ключ	Montaj Vidası Mounting Screw Монтажный винт
AFM90-AN11-D040-A16-Z04-H	●	40	4	16	40	11	ANGX 1105..	4010-M3x8	80-T10	2506-M8x30
AFM90-AN1506-D050-A22-Z04-H	●	50	4	22	40	14.5	ANGX 1506..	4015-M4x12	80-T15	2508-M10x30
AFM90-AN1506-D063-A22-Z05-H	●	63	5	22	40	14.5				2510-M12x35
AFM90-AN1506-D080-A27-Z06-H	●	80	6	27	50	14.5				2514-M16x35
AFM90-AN1506-D100-A32-Z08-H	●	100	8	32	50	14.5				-
AFM90-AN1506-D125-B40-Z09	●	125	9	40	63	14.5				-
AFM90-AN1506-D160-C40-Z10	●	160	10	40	63	14.5	-	-	-	

ZCC Ucuna Uygundur. / Compatible with ZCC Insert. / Под пластину ZCC

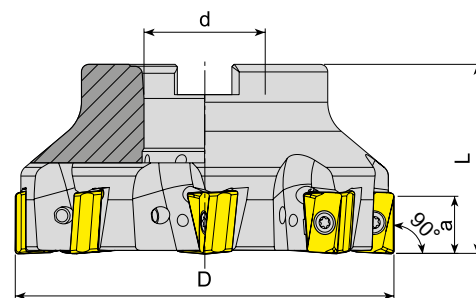

Takım Kodu Ordering Code Код для заказа	Stok Stock Наличие	Takım Ölçüleri (mm) Dimension (mm) Размеры (мм)					Kesici Uç Insert Пластина	Yedek Parçaları / Spare Parts / Запасные части		
		D	Z	d	L	a		Sıkma Vidası Screw Зажимной винт	Tork Anahtar Torx Key Торх Ключ	Montaj Vidası Mounting Screw Монтажный винт
AFM90-AN1607-D050-A22-Z04-H	●	50	4	22	40	15	AN.X 1607..	4015-M4x11	80-T15	2508-M10x30
AFM90-AN1607-D063-A22-Z06-H	●	63	6	22	40	15				2510-M12x35
AFM90-AN1607-D080-A27-Z07-H	●	80	7	27	50	15				2514-M16x35
AFM90-AN1607-D100-A32-Z08-H	●	100	8	32	50	15				-
AFM90-AN1607-D125-B40-Z10	●	125	9	40	63	15				-

R: Sağ / Right / Правый L: Sol/Left/Левый
● Stokta / In Stock / В наличии ○ Stokta Yok / Non Stock Item / Нет в наличии
TGTC Ucuna Uygundur. / Compatible with TGTC Insert. / Под пластину TGTC

Sipariş Örneği/Ordering Example/Образец заказа
1 ad./pcs./шт AFM90-AN11-D040-A16-Z04-H
Kesme Hesabı : S 321 / Cutting Calculation : P 321 / Расчет режимов резания: стр. 321
Montaj Ölçüleri : S 318 / Mounting Reference : P 318 / Инструкция по установке фрез: стр. 318

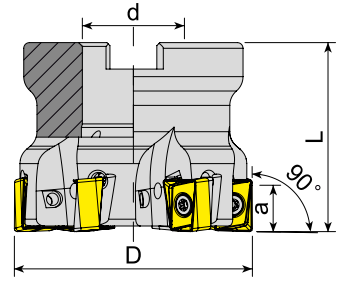

Takım Kodu Ordering Code Код для заказа	Stok Stock Наличие	Takım Ölçüleri (mm) Dimension (mm) Размеры (мм)					Kesici Uç Insert Пластина	Yedek Parçaları / Spare Parts / Запасные части		
		D	Z	d	L	a		Sıkma Vidası Screw Зажимной винт	Tork Anahtar Torx Key Торкс Ключ	Montaj Vidası Mounting Screw Монтажный винт
AFM90-AN12-D040-A16-Z04-H	●	40	4	16	40	12	ANKX 1205..	4015-M4x12	80-T15	2406-M8x30
AFM90-AN12-D050-A22-Z05-H	●	50	5	22	40	12				2508-M10x30
AFM90-AN12-D063-A27-Z06-H	●	63	6	27	50	12				2510-M12x35

ISCR Ucuna Uygun. / Compatible with ISCR Insert. / Под пластину ISCR

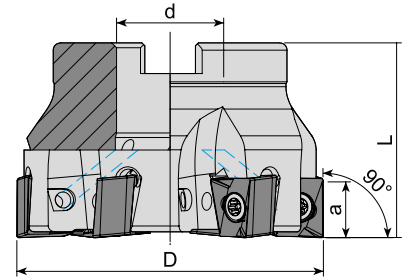

Takım Kodu Ordering Code Код для заказа	Stok Stock Наличие	Takım Ölçüleri (mm) Dimension (mm) Размеры (мм)					Kesici Uç Insert Пластина	Yedek Parçaları / Spare Parts / Запасные части		
		D	Z	d	L	a		Sıkma Vidası Screw Зажимной винт	Tork Anahtar Torx Key Торкс Ключ	Montaj Vidası Mounting Screw Монтажный винт
AFM90-AN1207-D040-A16-Z04-H	●	40	4	16	40	10	ANKX 1207..	4015-M4x11	80-T15	2506-M8x30
AFM90-AN1207-D050-A22-Z05-H	●	50	5	22	40	10				2508-M10x30
AFM90-AN1207-D063-A22-Z06-H	●	63	6	22	40	10				2510-M12x35
AFM90-AN1607X-D050-A22-Z04-H	●	50	4	22	40	15	ANKX 1607..	4015-M4x11	80-T15	2506-M8x30
AFM90-AN1607X-D063-A22-Z06-H	●	63	6	22	40	15				2508-M10x30
AFM90-AN1607X-D080-A27-Z07-H	●	80	7	27	50	15				2510-M12x35

R: Sağ / Right / Правый L: Sol/Left/Левый

● Stokta / In Stock / В наличии ○ Stokta Yok / Non Stock Item / Нет в наличии

XTC-GSC Ucuna Uygun. / Compatible with XTC-GSC Insert. / Под пластину XTC-GSC

Sipariş Örneği/Ordering Example/Образец заказа

1 ad./pcs./шт AFM90-AN12-D040-A16-Z04-H

Kesme Hesabı : S 321 / Cutting Calculation : P 321 / Расчет режимов резания: стр. 321

Montaj Ölçüleri : S 318 / Mounting Reference : P 318 / Инструкция по установке фрез: стр. 318

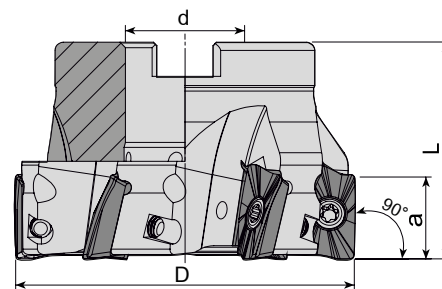

Takım Kodu Ordering Code Код для заказа	Stok Stock Наличие	Takım Ölçüleri (mm) Dimension (mm) Размеры (мм)					Kesici Uç Insert Пластина	Yedek Parçaları / Spare Parts / Запасные части			
		D	Z	d	L	a		Sikma Vidası Screw Зажимной винт	Tork Anahtar Torx Key Торх Ключ	Montaj Vidası Mounting Screw Монтажный винт	
AFM90-AO1236-D050-A22-Z05-H	●	50	5	22	40	12					
AFM90-AO1848-D050-A22-Z05-H	●	50	5	22	40	15		AO.. 1236..	3008-M2.5x6		80-T08
AFM90-AO1848-D063-A22-Z06-H	●	63	6	22	40	15		AO.. 1848..	4015-M4x11		80-T15

MTSBH Ucuna Uygundur. / Compatiple with MTSBH Insert. / Под пластину MTSBH

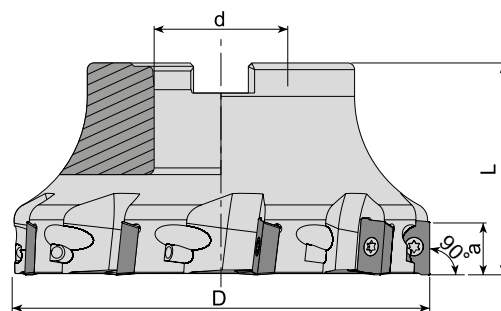

Takım Kodu Ordering Code Код для заказа	Stok Stock Наличие	Takım Ölçüleri (mm) Dimension (mm) Размеры (мм)					Kesici Uç Insert Пластина	Yedek Parçaları / Spare Parts / Запасные части		
		D	Z	d	L	a		Sikma Vidası Screw Зажимной винт	Tork Anahtar Torx Key Торх Ключ	Montaj Vidası Mounting Screw Монтажный винт
AFM90-AP1705-D050-A22-Z05-H	●	50	5	22	40	16				
AFM90-AP1705-D063-A22-Z06-H	●	63	6	22	40	16				
AFM90-AP1705-D080-A27-Z07-H	●	80	7	27	50	16				
AFM90-AP1705-D100-A32-Z08-H	●	100	8	32	50	16				

R: Sağ / Right / Правый L: Sol/Left/Левый
● Stokta / In Stock / В наличии ○ Stokta Yok / Non Stock Item / Нет в наличии
TGTC Ucuna Uygundur. / Compatiple with TGTC Insert. / Под пластину TGTC

Sipariş Örneği/Ordering Example/Образец заказа
1 ad./pcs./шт AFM90-AO1236-D050-A22-Z05-H
Kesme Hesabı : S 321 / Cutting Calculation : P 321 / Расчет режимов резания: стр. 321
Montaj Ölçüleri : S 318 / Mounting Reference : P 318 / Инструкция по установке фрез: стр. 318

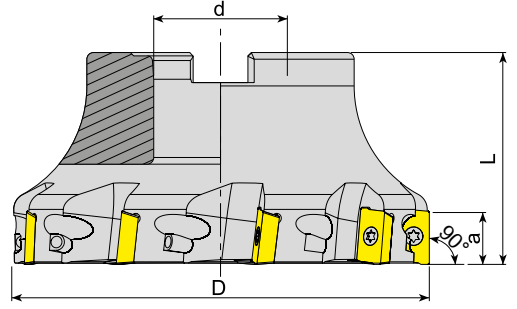

Yedek Parçaları / Spare Parts / Запасные части

Takım Kodu Ordering Code Код для заказа	Stok Stock Наличие	Takım Ölçüleri (mm) Dimension (mm) Размеры (мм)					Kesici Uç Insert Пластина	Yedek Parçaları / Spare Parts / Запасные части			
		D	Z	d	L	a		Sıkma Vidası Screw Зажимной винт	Tork Anahtar Torx Key Торх Ключ	Montaj Vidası Mounting Screw Монтажный винт	
AFM90-AP10-D040-A16-Z05-H	●	40	5	16	40	10	AP.. 1003.. ISO UCUNA UYGUNDUR. FOR ISO INSERT. Под пластину ISO	3008-M2.5x6	80-T08	2506-M8x30	
AFM90-AP10-D050-A22-Z06-H	●	50	6	22	40	10				2508-M10x30	
AFM90-AP10-D063-A22-Z07-H	●	63	7	22	40	10				2510-M12x35	
AFM90-AP10-D080-A27-Z08-H	●	80	8	27	50	10				2514-M16x35	
AFM90-AP10-D100-A32-Z09-H	●	100	9	32	50	10				2506-M8x30	
AFM90-AP16-D040-A16-Z04-H	●	40	4	16	40	16	AP.. 1604.. ISO UCUNA UYGUNDUR. FOR ISO INSERT. Под пластину ISO	4015-M4x11	80-T15	2508-M10x30	
AFM90-AP16-D050-A22-Z05-H	●	50	5	22	40	16				2510-M12x35	
AFM90-AP16-D052-A22-Z05-H	●	52	5	22	40	16				2514-M16x35	
AFM90-AP16-D063-A22-Z06-H	●	63	6	22	40	16				-	
AFM90-AP16-D080-A27-Z07-H	●	80	7	27	50	16				2506-M8x30	
AFM90-AP16-D100-A32-Z08-H	●	100	8	32	50	16				2508-M10x30	
AFM90-AP16-D125-B40-Z09	●	125	9	40	63	16				2510-M12x35	
AFM90-AP16-D160-C40-Z10	●	160	10	40	63	16				2514-M16x35	
AFM90-AP16-D200-C60-Z12	●	200	12	60	63	16				-	
AFM90-AP16DJ-D050-A22-Z05-H	●	50	5	22	40	16				AP.. 1604.. DJT UCUNA UYGUNDUR. FOR DJT INSERT. Под пластину DJT	2508-M10x30
AFM90-AP16DJ-D063-A22-Z06-H	●	63	6	22	40	16				2510-M12x35	
AFM90-AP16DJ-D080-A27-Z07-H	●	80	7	27	50	16				2514-M16x35	
AFM90-AP16L-D050-A22-Z05-H	●	50	5	22	40	16	AP.. 1604.. LMN UCUNA UYGUNDUR. FOR LMN INSERT. Под пластину LMN	2508-M10x30			
AFM90-AP16L-D063-A22-Z06-H	●	63	6	22	40	16	2510-M12x35				
AFM90-AP16L-D080-A27-Z07-H	●	80	7	27	50	16	2514-M16x35				
AFM90-AP16P-D040-A16-Z04-H	●	40	4	16	40	16	AP.. 1604.. PLBT UCUNA UYGUNDUR. FOR PLBT INSERT. Под пластину PLBT	2506-M8x30			
AFM90-AP16P-D050-A22-Z05-H	●	50	5	22	40	16	2508-M10x30				
AFM90-AP16P-D063-A22-Z06-H	●	63	6	22	40	16	2510-M12x35				
AFM90-AP16P-D080-A27-Z07-H	●	80	7	27	50	16	2514-M16x35				
AFM90-AP16P-D100-A32-Z08-H	●	100	8	32	50	16	2506-M8x30				
AFM90-AP16A-D050-A22-Z05-H	●	50	5	22	40	15	AP.. 1604.. ACHTK UCUNA UYGUNDUR. FOR ACHTK INSERT. Под пластину ACHTK	2508-M10x30			
AFM90-AP16A-D063-A22-Z06-H	●	63	6	22	40	15	2510-M12x35				
AFM90-AP16A-D080-A27-Z07-H	●	80	7	27	50	15	2514-M16x35				
AFM90-AP16A-D100-A32-Z08-H	●	100	8	32	50	15	-				
AFM90-AP16A-D125-B40-Z09	●	125	9	40	63	15	-				

R: Sağ / Right / Правый L: Sol/Left/Левый

● Stokta / In Stock / В наличии ○ Stokta Yok / Non Stock Item / Нет в наличии

Sipariş Örneği/Ordering Example/Образец заказа

1 ad./pcs./шт AFM90-AP10-D040-A16-Z05-H

Kesme Hesabı : S 321 / Cutting Calculation : P 321 / Расчет режимов резания: стр. 321

Montaj Ölçüleri : S 318 / Mounting Reference : P 318 / Инструкция по установке фрез: стр. 318

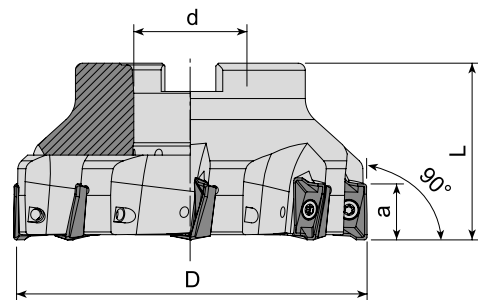

Takım Kodu Ordering Code Код для заказа	Stok Stock Наличие	Takım Ölçüleri (mm) Dimension (mm) Размеры (мм)					Kesici Uç Insert Пластина	Yedek Parçaları / Spare Parts / Запасные части		
		D	Z	d	L	a		Sıkma Vidası Screw Зажимной винт	Tork Anahtar Torx Key Торх Ключ	Montaj Vidası Mounting Screw Монтажный винт
AFM90-AX1235-D040-A16-Z06-H	●	40	6	16	40	10	AX.T 1235..		80-T08	2506-M8x30
AFM90-AX1235-D050-A22-Z07-H	●	50	7	22	40	10				2508-M10x30
AFM90-AX1235-D063-A22-Z08-H	●	63	8	22	40	10				2510-M12x35
AFM90-AX1235-D080-A27-Z10-H	●	80	10	27	50	10				2506-M8x30
AFM90-AX1705-D040-A16-Z04-H	●	40	4	16	40	14	AX.T 1705..	4015-M4x11	80-T15	2508-M10x30
AFM90-AX1705-D050-A22-Z05-H	●	50	5	22	40	14				2510-M12x35
AFM90-AX1705-D063-A22-Z06-H	●	63	6	22	40	14				2514-M16x35
AFM90-AX1705-D080-A27-Z07-H	●	80	7	27	50	14				
AFM90-AX1705-D100-A32-Z08-H	●	100	8	32	50	14				

SMTM Ucuna Uygundur. / Compatible with SMTM Insert. / SMTM Под пластину

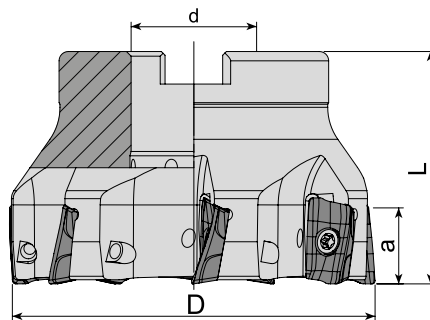

Takım Kodu Ordering Code Код для заказа	Stok Stock Наличие	Takım Ölçüleri (mm) Dimension (mm) Размеры (мм)					Kesici Uç Insert Пластина	Yedek Parçaları / Spare Parts / Запасные части		
		D	Z	d	L	a		Sıkma Vidası Screw Зажимной винт	Tork Anahtar Torx Key Торх Ключ	Montaj Vidası Mounting Screw Монтажный винт
AFM90-BD1704-D050-A22-Z05-H	●	50	5	22	40	15.7	BDMT 1704..	4015-M4x11	80-T15	2508-M10x30
AFM90-BD1704-D063-A22-Z06-H	●	63	6	22	40	15.7				2510-M12x35
AFM90-BD1704-D080-A27-Z07-H	●	80	7	27	50	15.7				

R: Sağ / Right / Правый L: Sol/Left/Левый
● Stokta / In Stock / В наличии ○ Stokta Yok / Non Stock Item / Нет в наличии
KYCR Ucuna Uygundur. / Compatible with KYCR Insert. / Под пластину KYCR

Sipariş Örneği/Ordering Example/Образец заказа
1 ad./pcs./шт AFM90-AX1235-D040-A16-Z06-H
Kesme Hesabı : S 321 / Cutting Calculation : P 321 / Расчет режимов резания: стр. 321
Montaj Ölçüleri : S 318 / Mounting Reference : P 318 / Инструкция по установке фрез: стр. 318



90°

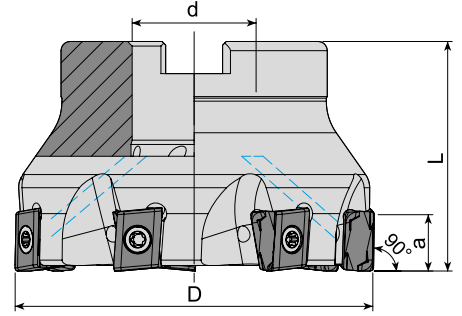

Takım Kodu Ordering Code Код для заказа	Stok Stock Наличие	Takım Ölçüleri (mm) Dimension (mm) Размеры (мм)					Kesici Uç Insert Пластина	Yedek Parçaları / Spare Parts / Запасные части		
		D	Z	d	L	a		Sıkma Vidası Screw Зажимной винт	Tork Anahtar Torx Key Торх Ключ	Montaj Vidası Mounting Screw Монтажный винт
AFM90-LN1506X-D063-A22-Z06	●	63	6	22	40	7	LNMT 1506..	3015-M4x11	80-T15	2508-M10x30
AFM90-LN1506X-D080-A27-Z07	●	80	7	27	50	7				
AFM90-LN1506X-D100-A32-Z08	●	100	8	32	50	7				

XTC-GSC Ucuna Uygun dur. / Compatible with XTC-GSC Insert. / Под пластину XTC-GSC



90°

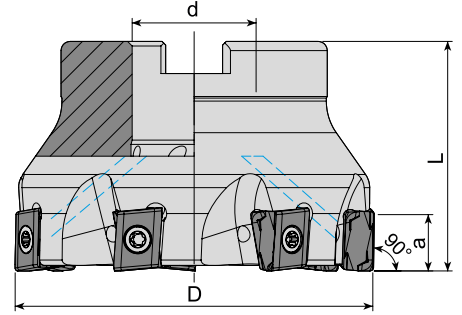

Takım Kodu Ordering Code Код для заказа	Stok Stock Наличие	Takım Ölçüleri (mm) Dimension (mm) Размеры (мм)					Kesici Uç Insert Пластина	Yedek Parçaları / Spare Parts / Запасные части		
		D	Z	d	L	a		Sıkma Vidası Screw Зажимной винт	Tork Anahtar Torx Key Торх Ключ	Montaj Vidası Mounting Screw Монтажный винт
AFM90-LN1306W-D050-A22-Z05-H	●	50	5	22	40	12	LNHU 1306..	4115-M4x12	80-T15	2508-M10x30
AFM90-LN1306W-D063-A22-Z06-H	●	63	6	22	40	12				
AFM90-LN1306W-D080-A27-Z07-H	●	80	7	27	50	12				

R: Sağ / Right / Правый L: Sol/Left/Левый

● Stokta / In Stock / В наличии ○ Stokta Yok / Non Stock Item / Нет в наличии

WLTR Ucuna Uygun dur. / Compatible with WLTR Insert. / Под пластину WLTR

Sipariş Örneği/Ordering Example/Образец заказа

1 ad./pcs./шт AFM90-LN1506X-D063-A22-Z06

Kesme Hesabı : S 321 / Cutting Calculation : P 321 / Расчет режимов резания: стр. 321

Montaj Ölçüleri : S 318 / Mounting Reference : P 318 / Инструкция по установке фрез: стр. 318

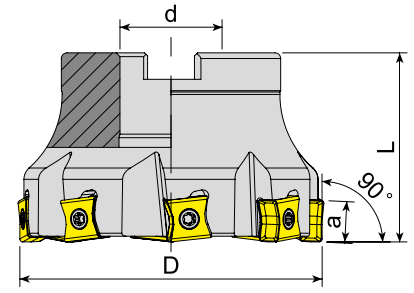

Takım Kodu Ordering Code Код для заказа	Stok Stock Наличие	Takım Ölçüleri (mm) Dimension (mm) Размеры (мм)					Kesici Uç Insert Пластина	Yedek Parçaları / Spare Parts / Запасные части		
		D	Z	d	L	a		Sıkma Vidası Screw Зажимной винт	Tork Anahtar Torx Key Торх Ключ	Montaj Vidası Mounting Screw Монтажный винт
AFM90-LN1106-D050-A22-Z05	●	50	5	22	40	10	LNMT 1106..	4015-M3.5x11	80-T15	2508-M10x30
AFM90-LN1106-D063-A22-Z06	●	63	6	22	40	10				2510-M12x35
AFM90-LN1106-D080-A27-Z08	●	80	8	27	50	10				2514-M16x35
AFM90L-LN1106-D080-A27-Z08	●	80	8	27	50	10				-
AFM90-LN1106-D100-A32-Z09	●	100	9	32	50	10				2506-M8x30
AFM90L-LN1106-D100-A32-Z09	●	100	9	32	50	10				2508-M10x30
AFM90-LN1106-D125-B40-Z10	●	125	10	40	63	10				2510-M12x35
AFM90-LN1306-D040-A16-Z04-H	●	40	4	16	40	12.5	T490 LNMT 1306..	4015-M4x11	80-T15	2514-M16x35
AFM90-LN1306-D050-A22-Z05-H	●	50	5	22	40	12.5				2506-M8x30
AFM90-LN1306-D063-A22-Z06-H	●	63	6	22	40	12.5				2508-M10x30
AFM90-LN1306-D080-A27-Z07-H	●	80	7	27	50	12.5				2510-M12x35
AFM90-LN1306-D100-A32-Z08-H	●	100	8	32	50	12.5				2514-M16x35
AFM90L-LN1506-D040-A16-Z04	○	40	4	16	40	14	LNMT 1506..	4015-M4x11	80-T20	2506-M8x30
AFM90-LN1506-D040-A16-Z04	○	40	4	16	40	14				2508-M10x30
AFM90-LN1506-D050-A22-Z05	○	50	5	22	40	14				2510-M12x35
AFM90-LN1506-D063-A22-Z06	○	63	6	22	40	14				2514-M16x35
AFM90-LN1506-D080-A27-Z07	○	80	7	27	50	14				-
AFM90-LN1607-D050-A22-Z03-H	●	50	3	22	40	16	LNHT 1607..	4420-M5x14	80-T20	2506-M8x30
AFM90-LN1607-D063-A22-Z04-H	○	63	4	22	40	16				2508-M10x30
AFM90-LN1607-D080-A27-Z05-H	●	80	5	27	50	16				2510-M12x35
AFM90-LN1607-D100-A32-Z06-H	●	100	6	32	50	16				2514-M16x35

R: Sağ / Right / Правый L: Sol/Left/Левый
● Stokta / In Stock / В наличии ○ Stokta Yok / Non Stock Item / Нет в наличии
ISCR Ucuna Uygunudur. / Compatiple with ISCR Insert. / Под пластину ISCR

Sipariş Örneği/Ordering Example/Образец заказа
1 ad./pcs./шт AFM90-LN1106-D050-A22-Z05

Kesme Hesabı : S 321 / Cutting Calculation : P 321 / Расчет режимов резания: стр. 321
Montaj Ölçüleri : S 318 / Mounting Reference : P 318 / Инструкция по установке фрез: стр. 318

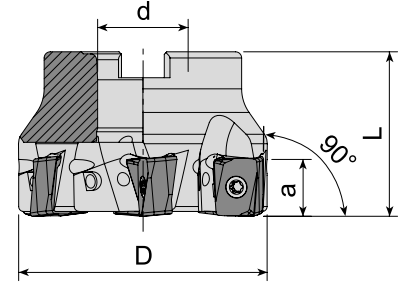

Takım Kodu Ordering Code Код для заказа	Stok Stock Наличие	Takım Ölçüleri (mm) Dimension (mm) Размеры (мм)					Kesici Uç Insert Пластина	Yedek Parçaları / Spare Parts / Запасные части		
		D	Z	d	L	a		Sıkma Vidası Screw Зажимной винт	Tork Anahtar Torx Key Торх Ключ	Montaj Vidası Mounting Screw Монтажный винт
AFM90-LN1307-D050-A22-Z04-H	●	50	4	22	40	13	LNKX 1307..	1315-M4x11	80-T15	2508-M10x30
AFM90-LN1307-D063-A22-Z06-H	●	63	6	22	40	13				2510-M12x35
AFM90-LN1307-D080-A27-Z07-H	●	80	7	27	50	13				2514-M16x35
AFM90-LN1307-D100-A32-Z08-H	●	100	8	32	50	13				-

WLTR Ucuna Uygun. / Compatible with WLTR Insert. / Под пластину WLTR

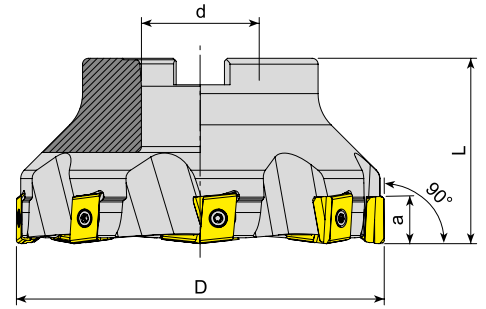

Takım Kodu Ordering Code Код для заказа	Stok Stock Наличие	Takım Ölçüleri (mm) Dimension (mm) Размеры (мм)					Kesici Uç Insert Пластина	Yedek Parçaları / Spare Parts / Запасные части		
		D	Z	d	L	a		Sıkma Vidası Screw Зажимной винт	Tork Anahtar Torx Key Торх Ключ	Montaj Vidası Mounting Screw Монтажный винт
AFM90-LN15Z-D050-A22-Z04	●	50	4	22	40	15	LNKT 1506..	4015-M4x11	80-T15	2508-M10x30
AFM90-LN15Z-D063-A22-Z05	●	63	5	22	40	15				2510-M12x35
AFM90-LN15Z-D080-A27-Z06	●	80	6	27	50	15				2514-M16x35
AFM90-LN15Z-D100-A32-Z07	●	100	7	32	50	15				-
AFM90-LN15Z-D125-B40-Z08	●	125	8	40	63	15				-

R: Sağ / Right / Правый L: Sol/Left/Левый
● Stokta / In Stock / В наличии ○ Stokta Yok / Non Stock Item / Нет в наличии
ZCC Ucuna Uygun. / Compatible with ZCC Insert. / Под пластину ZCC

Sipariş Örneği/Ordering Example/Образец заказа
1 ad./pcs./шт AFM90-LN1506X-D063-A22-Z06

Kesme Hesabı : S 321 / Cutting Calculation : P 321 / Расчет режимов резания: стр. 321
Montaj Ölçüleri : S 318 / Mounting Reference : P 318 / Инструкция по установке фрез: стр. 318

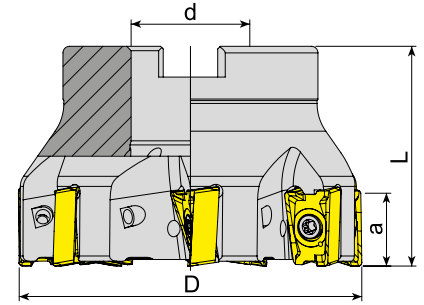

Takım Kodu Ordering Code Код для заказа	Stok Stock Наличие	Takım Ölçüleri (mm) Dimension (mm) Размеры (мм)					Kesici Uç Insert Пластина	Yedek Parçaları / Spare Parts / Запасные части			
		D	Z	d	L	a		Sıkma Vidası Screw Зажимной винт	Tork Anahtar Torx Key Торх Ключ	Montaj Vidası Mounting Screw Монтажный винт	
AFM90-LN15T6-D050-A22-Z05-H	●	50	5	22	40	15.5	LNGU 15T6..	4015-M4x12	80-T15	2508-M10x30	
AFM90-LN15T6-D063-A22-Z06-H	●	63	6	22	40	15.5					
AFM90-LN15T6-D080-A27-Z07-H	●	80	7	27	50	15.5					2510-M12x35

KNMTL Ucuna Uygunudur. / Compatible with KNMTL Insert. / Под пластину KNMTL

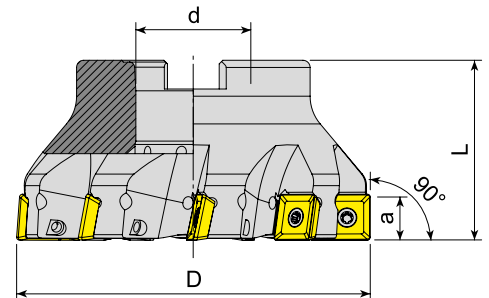

Takım Kodu Ordering Code Код для заказа	Stok Stock Наличие	Takım Ölçüleri (mm) Dimension (mm) Размеры (мм)					Kesici Uç Insert Пластина	Yedek Parçaları / Spare Parts / Запасные части			
		D	Z	d	L	a		Sıkma Vidası Screw Зажимной винт	Tork Anahtar Torx Key Торх Ключ	Montaj Vidası Mounting Screw Монтажный винт	
AFM90-R290.12-D050-A22-Z04-H	●	50	4	22	40	10.7	R290-12T3..	4015-M3.5x11	80-T15	2508-M10x30	
AFM90-R290.12-D063-A22-Z05-H	●	63	5	22	40	10.7					
AFM90-R290.12-D080-A27-Z07-H	●	80	7	27	50	10.7				2510-M12x35	
AFM90-R290.12-D100-A32-Z09-H	●	100	9	32	50	10.7				2514-M16x35	
AFM90-R290.12-D125-B40-Z11	●	125	11	40	63	10.7				-	

R: Sağ / Right / Правый L: Sol/Left/Левый
● Stokta / In Stock / В наличии ○ Stokta Yok / Non Stock Item / Нет в наличии
SNDVK Ucuna Uygunudur. / Compatible with SNDVK Insert. / Под пластину SNDVK

Sipariş Örneği/Ordering Example/Образец заказа
1 ad./pcs./шт AFM90-LN15T6-D050-A22-Z05-H
Kesme Hesabı : S 321 / Cutting Calculation : P 321 / Расчет режимов резания: стр. 321
Montaj Ölçüleri : S 318 / Mounting Reference : P 318 / Инструкция по установке фрез: стр. 318

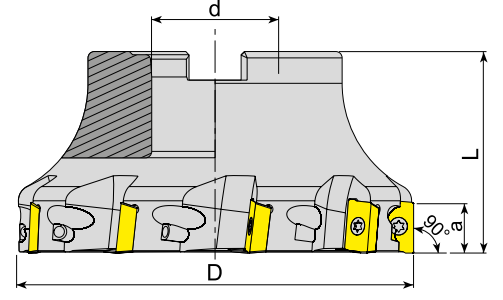

Takım Kodu Ordering Code Код для заказа	Stok Stock Наличие	Takım Ölçüleri (mm) Dimension (mm) Размеры (мм)					Kesici Uç Insert Пластина	Yedek Parçaları / Spare Parts / Запасные части			
		D	Z	d	L	a		Sıkma Vidası Screw Зажимной винт	Tork Anahtar Torx Key Торх Ключ	Montaj Vidası Mounting Screw Монтажный винт	
AFM90-R390.11-D040-A16-Z05-H	●	40	5	16	40	10	R390-11T3..	3008-M2.5x6	80-T08	2506-M8x30	
AFM90-R390.11-D050-A22-Z06-H	●	50	6	22	40	10				2508-M10x30	
AFM90-R390.11-D063-A22-Z07-H	●	63	7	22	40	10				2510-M12x35	
AFM90-R390.11-D080-A27-Z09-H	●	80	9	27	50	10				-	
AFM90-R390.17-D040-A16-Z04-H	●	40	4	16	40	15.4	R390-1704..	4015-M3.5x11	80-T15	2506-M8x30	
AFM90-R390.17-D050-A22-Z05-H	●	50	5	22	40	15.4				2508-M10x30	
AFM90-R390.17-D063-A22-Z06-H	●	63	6	22	40	15.4				2510-M12x35	
AFM90-R390.17-D080-A27-Z07-H	●	80	7	27	50	15.4				2514-M16x35	
AFM90-R390.17-D100-A32-Z08-H	●	100	8	32	50	15.4	R390-1806..	4015-M4x11	80-T15	-	
AFM90-R390.17-D125-B40-Z09	●	125	9	40	63	15.4				2508-M10x30	
AFM90-R390.18-D050-A22-Z04-H	●	50	4	22	40	15.4				2510-M12x35	
AFM90-R390.18-D063-A22-Z05-H	●	63	5	22	40	15.4				2514-M16x35	
AFM90-R390.18-D080-A27-Z06-H	●	80	6	27	50	15.4	R390-1806..	4015-M4x11	80-T15	-	
AFM90-R390.18-D100-A32-Z07-H	●	100	7	32	50	15.4				2508-M10x30	
AFM90-R390.18-D125-B40-Z08	●	125	8	40	63	15.4				2510-M12x35	

SNDVK Ucuna Uygunudur. / Compatible with SNDVK Insert. / Под пластину SNDVK

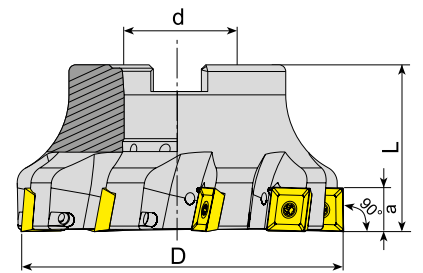

Takım Kodu Ordering Code Код для заказа	Stok Stock Наличие	Takım Ölçüleri (mm) Dimension (mm) Размеры (мм)					Kesici Uç Insert Пластина	Yedek Parçaları / Spare Parts / Запасные части			
		D	Z	d	L	a		Sıkma Vidası Screw Зажимной винт	Tork Anahtar Torx Key Торх Ключ	Montaj Vidası Mounting Screw Монтажный винт	
AFM90-490R14-D050-A22-Z04-H	●	50	4	22	40	10	490R-1404..	4015-M3.5x11	80-T15	2508-M10x30	
AFM90-490R14-D063-A22-Z05-H	●	63	5	22	40	10				2510-M12x35	
AFM90-490R14-D080-A27-Z07-H	●	80	7	27	50	10				-	

R: Sağ / Right / Правый L: Sol/Left/Левый

● Stokta / In Stock / В наличии ○ Stokta Yok / Non Stock Item / Нет в наличии

SNDVK Ucuna Uygunudur. / Compatible with SNDVK Insert. / Под пластину SNDVK



Sipariş Örneği/Ordering Example/Образец заказа

1 ad./pcs./шт AFM90-R390.11-D040-A16-Z05-H

Kesme Hesabı : S 321 / Cutting Calculation : P 321 / Расчет режимов резания: стр. 321

Montaj Ölçüleri : S 318 / Mounting Reference : P 318 / Инструкция по установке фрез: стр. 318

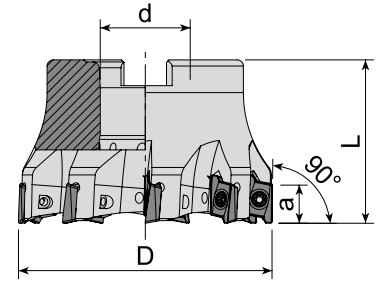

Takım Kodu Ordering Code Код для заказа	Stok Stock Наличие	Takım Ölçüleri (mm) Dimension (mm) Размеры (мм)					Kesici Uç Insert Пластина	Yedek Parçaları / Spare Parts / Запасные части				
		D	Z	d	L	a		Sıkma Vidası Screw Зажимной винт	Tork Anahtar Torx Key Торх Ключ	Montaj Vidası Mounting Screw Монтажный винт		
AFM90-RT10-D040-A16-Z06-H	●	40	6	16	40	10	RT 1003..			2506-M8x30		
AFM90-RT10-D050-A22-Z07-H	●	50	7	22	40	10				3008-M2.5x6	80-T08	2407-M10x30
AFM90-RT10-D063-A22-Z09-H	●	63	9	22	40	10						

SFTY Ucuna Uygundur. / Compatible with SFTY Insert. / Под пластину SFTY

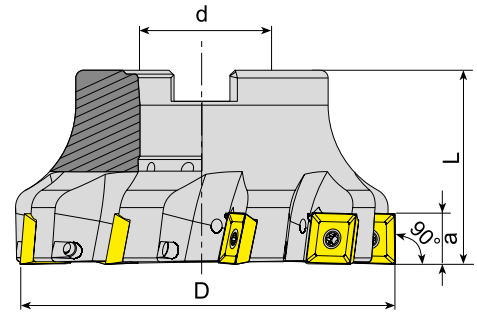

Takım Kodu Ordering Code Код для заказа	Stok Stock Наличие	Takım Ölçüleri (mm) Dimension (mm) Размеры (мм)					Kesici Uç Insert Пластина	Yedek Parçaları / Spare Parts / Запасные части				
		D	Z	d	L	a		Sıkma Vidası Screw Зажимной винт	Tork Anahtar Torx Key Торх Ключ	Montaj Vidası Mounting Screw Монтажный винт		
AFM90-SD09M4-D040-A16-Z04-H	●	40	4	16	40	9	SD.. 09M4..			2406-M8x30		
AFM90-SD09M4-D050-A22-Z05-H	●	50	5	22	40	9				4015-M3.5x11	80-T15	2508-M10x30
AFM90-SD09M4-D063-A22-Z06-H	●	63	6	22	40	9						2510-M12x35
AFM90-SD09M4-D080-A27-Z07-H	●	80	7	27	50	9						2408-M10x30
AFM90-SD1305-D050-A22-Z04-H	●	50	4	22	40	13	SD.. 1305..			2508-M10x30		
AFM90-SD1305-D063-A22-Z05-H	●	63	5	22	40	13				1020-M5x11	80-T20	2510-M12x35
AFM90-SD1305-D080-A27-Z06-H	●	80	6	27	50	13						2514-M16x35
AFM90-SD1305-D100-A32-Z07-H	●	100	7	32	50	13						-
AFM90-SD1305-D125-B40-Z08	●	125	8	40	63	13						
AFM90-SD1305-D160-C40-Z10	●	160	10	40	63	13						

R: Sağ / Right / Правый L: Sol/Left/Левый

● Stokta / In Stock / В наличии ○ Stokta Yok / Non Stock Item / Нет в наличии

KRLY Ucuna Uygundur. / Compatible with KRLY Insert. / Под пластину KRLY

Sipariş Örneği/Ordering Example/Образец заказа

1 ad./pcs./шт AFM90-RT10-D040-A16-Z06-H

Kesme Hesabı : S 321 / Cutting Calculation : P 321 / Расчет режимов резания: стр. 321

Montaj Ölçüleri : S 318 / Mounting Reference : P 318 / Инструкция по установке фрез: стр. 318

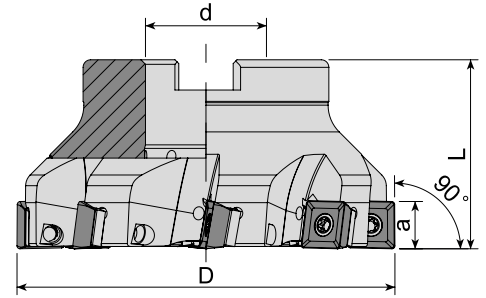

Takım Kodu Ordering Code Код для заказа	Stok Stock Наличие	Takım Ölçüleri (mm) Dimension (mm) Размеры (мм)					Kesici Uç Insert Пластина	Yedek Parçaları / Spare Parts / Запасные части				
		D	Z	d	L	a		Altlık Screw Опорная пластина	Altlık Vidası Wedge Clamp Винт опорной пластины	Sıkma Vidası Screw Зажимной винт	Tork Anahtar Torx Key Торх Ключ	Montaj Vidası Mounting Screw Монтажный винт
AFM90S-SD1204-D050-A22-Z04-H	●	50	4	22	40	11	SDMT 1204..	AASD-3-0001	AAV-08-M3.5x8	4015-M3.5x12	80-T15	2408-M10x30
AFM90S-SD1204-D063-A22-Z05-H	●	63	5	22	40	11						2508-M10x30
AFM90S-SD1204-D080-A27-Z06-H	●	80	6	27	50	11						2510-M12x35
AFM90S-SD1204-D100-A32-Z08-H	●	100	8	32	50	11						2514-M16x35
AFM90S-SD1204-D125-B40-Z10	●	125	10	40	63	11						-
AFM90S-SD1204-D160-C40-Z12	●	160	12	40	63	11						-

DJT Ucuna Uygunudur. / Compatible with DJT Insert. / Под пластину DJT

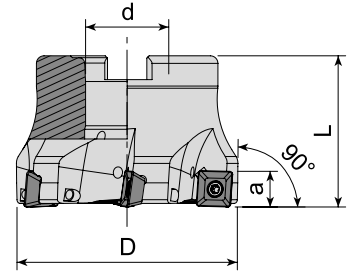

Takım Kodu Ordering Code Код для заказа	Stok Stock Наличие	Takım Ölçüleri (mm) Dimension (mm) Размеры (мм)					Kesici Uç Insert Пластина	Yedek Parçaları / Spare Parts / Запасные части		
		D	Z	d	L	a		Sıkma Vidası Screw Зажимной винт	Tork Anahtar Torx Key Торх Ключ	Montaj Vidası Mounting Screw Монтажный винт
AFM90-SE09-D040-A16-Z04-H	●	40	4	16	40	6.7	SEET 09T3..	3008-M3x8	80-T08	2506-M8x30
AFM90-SE09-D050-A22-Z05-H	●	50	5	22	40	6.7				2508-M10x30
AFM90-SE09-D063-A22-Z06-H	●	63	6	22	40	6.7				-

R: Sağ / Right / Правый L: Sol/Left/Левый
● Stokta / In Stock / В наличии ○ Stokta Yok / Non Stock Item / Нет в наличии
ZCC Ucuna Uygunudur. / Compatible with ZCC Insert. / Под пластину ZCC

Sipariş Örneği/Ordering Example/Образец заказа
1 ad./pcs./шт AFM90S-SD1204-D050-A22-Z04-H
Kesme Hesabı : S 321 / Cutting Calculation : P 321 / Расчет режимов резания: стр. 321
Montaj Ölçüleri : S 318 / Mounting Reference : P 318 / Инструкция по установке фрез: стр. 318

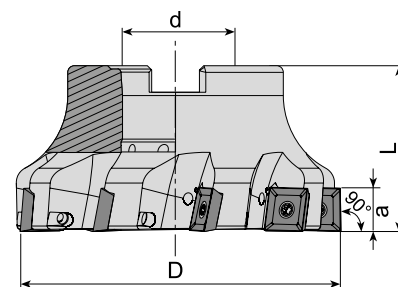

Takım Kodu Ordering Code Код для заказа	Stok Stock Наличие	Takım Ölçüleri (mm) Dimension (mm) Размеры (мм)					Kesici Uç Insert Пластина	Yedek Parçaları / Spare Parts / Запасные части		
		D	Z	d	L	a		Sıkma Vidası Screw Зажимной винт	Tork Anahtar Torx Key Торх Ключ	Montaj Vidası Mounting Screw Монтажный винт
AFM90-SE12-D050-A22-Z04-H	●	50	4	22	40	12	SEET 1203..	4015-M3.5x11	80-T15	2508-M10x30 2510-M12x35 2514-M16x35 -
AFM90-SE12-D063-A22-Z05-H	●	63	5	22	40	12				
AFM90-SE12-D080-A27-Z07-H	●	80	7	27	50	12				
AFM90-SE12-D100-A32-Z09-H	●	100	9	32	50	12				
AFM90-SE12-D125-B40-Z11	●	125	11	40	63	12				

ZCC Ucuna Uygun. / Compatible with ZCC Insert. / Под пластину ZCC

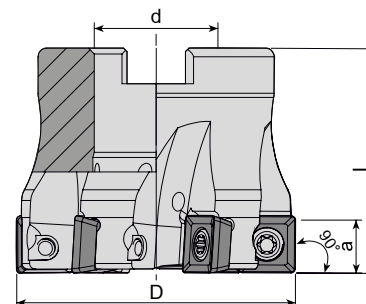

Takım Kodu Ordering Code Код для заказа	Stok Stock Наличие	Takım Ölçüleri (mm) Dimension (mm) Размеры (мм)					Kesici Uç Insert Пластина	Yedek Parçaları / Spare Parts / Запасные части		
		D	Z	d	L	a		Sıkma Vidası Screw Зажимной винт	Tork Anahtar Torx Key Торх Ключ	Montaj Vidası Mounting Screw Монтажный винт
AFM90-SP1004-D040-A16-Z04-H	●	40	4	16	40	9.4	SPMT 1004.. XPMT 1004.. QPMR 1004.. QPMT 1004..	4015-M4x10	80-T15	2506-M8x30 2508-M10x30 2510-M12x35 2514-M16x35
AFM90-SP1004-D050-A22-Z04-H	●	50	4	22	40	9.4				
AFM90-SP1004-D050-A22-Z06-H	●	50	6	22	40	9.4				
AFM90-SP1004-D063-A22-Z05-H	●	63	5	22	40	9.4				
AFM90-SP1004-D080-A27-Z07-H	●	80	7	27	50	9.4				
AFM90-SP1004-D100-A32-Z08-H	●	100	8	32	50	9.4				

R: Sağ / Right / Правый L: Sol/Left/Левый
● Stokta / In Stock / В наличии ○ Stokta Yok / Non Stock Item / Нет в наличии
ISCR Ucuna Uygun. / Compatible with ISCR Insert. / Под пластину ISCR

Sipariş Örneği/Ordering Example/Образец заказа
1 ad./pcs./шт AFM90-SE12-D050-A22-Z04-H
Kesme Hesabı : S 321 / Cutting Calculation : P 321 / Расчет режимов резания: стр. 321
Montaj Ölçüleri : S 318 / Mounting Reference : P 318 / Инструкция по установке фрез: стр. 318

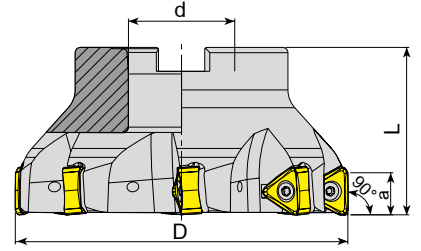

Takım Kodu Ordering Code Код для заказа	Stok Stock Наличие	Takım Ölçüleri (mm) Dimension (mm) Размеры (мм)					Kesici Uç Insert Пластина	Yedek Parçaları / Spare Parts / Запасные части		
		D	Z	d	L	a		Sıkma Vidası Screw Зажимной винт	Tork Anahtar Torx Key Торх Ключ	Montaj Vidası Mounting Screw Монтажный винт
AFM90-TN2207-D063-A22-Z04-H	●	63	4	22	40	15	TN.X 2207..	1120-M4.5x12	80-T20	2508-M10x30
AFM90-TN2207-D080-A27-Z05-H	●	80	5	27	50	15				2510-M12x35
AFM90-TN2207-D100-B32-Z06	●	100	6	32	50	15				-
AFM90-TN2207-D125-B40-Z08	●	125	8	40	63	15				-

TGTC Ucuna Uygunudur. / Compatiple with TGTC Insert. / Под пластину TGTC

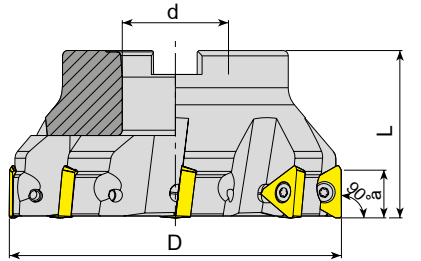

Takım Kodu Ordering Code Код для заказа	Stok Stock Наличие	Takım Ölçüleri (mm) Dimension (mm) Размеры (мм)					Kesici Uç Insert Пластина	Yedek Parçaları / Spare Parts / Запасные части		
		D	Z	d	L	a		Sıkma Vidası Screw Зажимной винт	Tork Anahtar Torx Key Торх Ключ	Montaj Vidası Mounting Screw Монтажный винт
AFM90-TP2205-D063-A22-Z04	●	63	4	22	40	18	TPKT 2205..	1120-M4.5x12	80-T20	2508-M10x30
AFM90-TP2205-D080-A27-Z06	●	80	6	27	50	18				2510-M12x35
AFM90-TP2205-D100-A32-Z07	●	100	7	32	50	18				2514-M16x35
AFM90-TP2205-D125-B40-Z08	●	125	8	40	63	18				-
AFM90-TP2205-D160-C40-Z09	●	160	9	40	63	18				-
AFM90-TP2205-D200-C60-Z12	●	200	12	60	63	18				-

R: Sağ / Right / Правый L: Sol/Left/Левый
● Stokta / In Stock / В наличии ○ Stokta Yok / Non Stock Item / Нет в наличии
TGTC Ucuna Uygunudur. / Compatiple with TGTC Insert. / Под пластину TGTC

Sipariş Örneği/Ordering Example/Образец заказа
1 ad./pcs./шт AFM90-TN2207-D063-A22-Z04-H

Kesme Hesabı : S 321 / Cutting Calculation : P 321 / Расчет режимов резания: стр. 321
Montaj Ölçüleri : S 318 / Mounting Reference : P 318 / Инструкция по установке фрез: стр. 318



90°

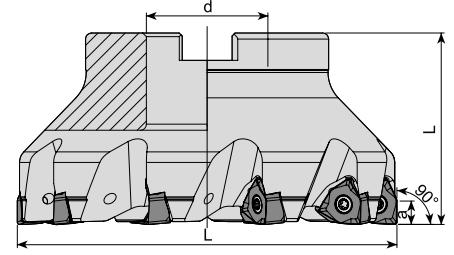

Takım Kodu Ordering Code Код для заказа	Stok Stock Наличие	Takım Ölçüleri (mm) Dimension (mm) Размеры (мм)					Kesici Uç Insert Пластина	Yedek Parçaları / Spare Parts / Запасные части		
		D	Z	d	L	a		Sıkma Vidası Screw Зажимной винт	Tork Anahtar Torx Key Торх Ключ	Montaj Vidası Mounting Screw Монтажный винт
AFM90-WN0604Z-D040-A16-Z04-H	●	40	4	16	16	5.7	WNHU 0604..	3008-M3x8	80-T08	2506-M8x30
AFM90-WN0604Z-D050-A22-Z05-H	●	50	5	22	22	5.7				2508-M10x30
AFM90-WN0604Z-D063-A22-Z06-H	●	63	6	22	22	5.7				2510-M12x35
AFM90-WN0604Z-D080-A27-Z07-H	●	80	7	27	27	5.7				2514-M16x35
AFM90-WN0604Z-D100-A32-Z09-H	●	100	9	32	32	5.7				-
AFM90-WN0806Z-D050-A22-Z04-H	●	50	4	22	22	7.7	WNHU 0806..	4015-M4x11	80-T15	2508-M10x30
AFM90-WN0806Z-D063-A22-Z05-H	●	63	5	22	22	7.7				2510-M12x35
AFM90-WN0806Z-D080-A27-Z06-H	●	80	6	27	27	7.7				2514-M16x35
AFM90-WN0806Z-D100-A32-Z08-H	●	100	8	32	32	7.7				-
AFM90-WN0806Z-D125-B40-Z10	●	125	10	40	40	7.7				-
AFM90-WN0806Z-D160-C40-Z12	●	160	12	40	40	7.7	-	-	-	

ZCC Ucuna Uygundur. / Compatible with ZCC Insert. / Под пластину ZCC

90°

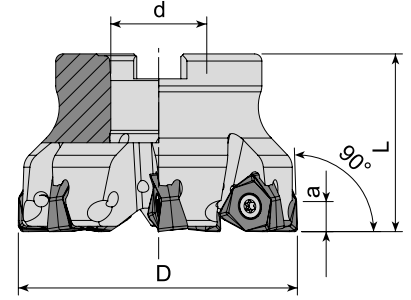

Takım Kodu Ordering Code Код для заказа	Stok Stock Наличие	Takım Ölçüleri (mm) Dimension (mm) Размеры (мм)					Kesici Uç Insert Пластина	Yedek Parçaları / Spare Parts / Запасные части		
		D	Z	d	L	a		Sıkma Vidası Screw Зажимной винт	Tork Anahtar Torx Key Торх Ключ	Montaj Vidası Mounting Screw Монтажный винт
AFM90-WN0806-D050-A16-Z04-H	●	50	4	16	40	8	WNMX 080608	1615-M5x14	80-T15	2506-M8x30
AFM90-WN0806-D063-A22-Z05-H	●	63	5	22	40	8				2508-M10x30
AFM90-WN0806-D080-A27-Z07-H	●	80	7	27	50	8				2510-M12x35

R: Sağ / Right / Правый L: Sol/Left/Левый

● Stokta / In Stock / В наличии ○ Stokta Yok / Non Stock Item / Нет в наличии

KYCR-JD Ucuna Uygundur. / Compatible with KYCR-JD Insert. / Под пластину KYCR-JD

Sipariş Örneği/Ordering Example/Образец заказа

1 ad./pcs./шт AFM90-WN0604Z-D040-A16-Z04-H

Kesme Hesabı : S 321 / Cutting Calculation : P 321 / Расчет режимов резания: стр. 321

Montaj Ölçüleri : S 318 / Mounting Reference : P 318 / Инструкция по установке фрез: стр. 318

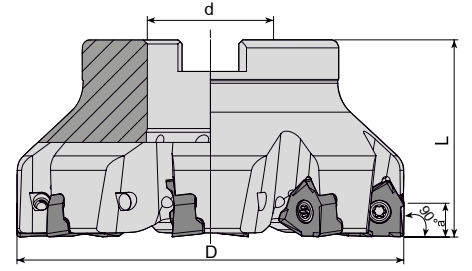

Takım Kodu Ordering Code Код для заказа	Stok Stock Наличие	Takım Ölçüleri (mm) Dimension (mm) Размеры (мм)					Kesici Uç Insert Пластина	Yedek Parçaları / Spare Parts / Запасные части			
		D	Z	d	L	a		Sıkma Vidası Screw Зажимной винт	Tork Anahtar Torx Key Торх Ключ	Montaj Vidası Mounting Screw Монтажный винт	
AFM90-XN0403-D040-A16-Z05-H	●	40	5	16	40	4	XNEX 0403..	4008-M2.5x6	80-T08	2506-M8x30	
AFM90-XN0806-D050-A22-Z04-H	●	50	4	22	40	7.5	XNEX 0806..	4015-M4x11	80-T15	2508-M10x30	
AFM90-XN0806-D063-A22-Z05-H	●	63	5	22	40	7.5				2510-M12x35	
AFM90-XN0806-D080-A27-Z07-H	●	80	7	27	50	7.5				2514-M16x35	
AFM90-XN0806-D100-A32-Z08-H	●	100	8	32	50	7.5					

SC Ucuna Uygundur. / Compatible with SC Insert. / Под пластину SC

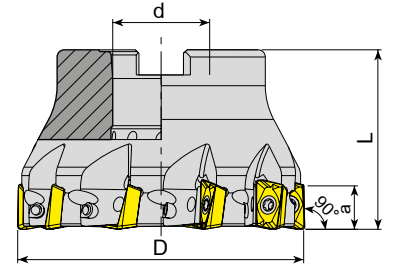

Takım Kodu Ordering Code Код для заказа	Stok Stock Наличие	Takım Ölçüleri (mm) Dimension (mm) Размеры (мм)					Kesici Uç Insert Пластина	Yedek Parçaları / Spare Parts / Запасные части			
		D	Z	d	L	a		Sıkma Vidası Screw Зажимной винт	Tork Anahtar Torx Key Торх Ключ	Montaj Vidası Mounting Screw Монтажный винт	
AFM90-X012-D040-A16-Z05-H	●	40	5	16	40	11	XO.. 1204..	3010-M3.5x9	80-T10	2506-M8x30	
AFM90-X012-D050-A22-Z07-H	●	50	7	22	40	11				2508-M10x30	
AFM90-X012-D063-A22-Z08-H	●	63	8	22	40	11				2510-M12x35	
AFM90-X012-D080-A27-Z10-H	●	80	10	27	50	11				2514-M16x35	
AFM90-X012-D100-A32-Z12-H	●	100	12	32	50	11					

R: Sağ / Right / Правый L: Sol/Left/Левый
● Stokta / In Stock / В наличии ○ Stokta Yok / Non Stock Item / Нет в наличии
SC Ucuna Uygundur. / Compatible with SC Insert. / Под пластину SC

Sipariş Örneği/Ordering Example/Образец заказа
1 ad./pcs./шт AFM90-XN0403-D040-A16-Z05-H

Kesme Hesabı : S 321 / Cutting Calculation : P 321 / Расчет режимов резания: стр. 321
Montaj Ölçüleri : S 318 / Mounting Reference : P 318 / Инструкция по установке фрез: стр. 318

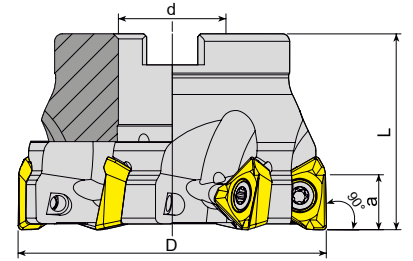

Takım Kodu Ordering Code Код для заказа	Stok Stock Наличие	Takım Ölçüleri (mm) Dimension (mm) Размеры (мм)					Kesici Uç Insert Пластина	Yedek Parçaları / Spare Parts / Запасные части		
		D	Z	d	L	a		Sıkma Vidası Screw Зажимной винт	Tork Anahtar Torx Key Торх Ключ	Montaj Vidası Mounting Screw Монтажный винт
AFM90-3P1004-D040-A16-Z05-H	●	40	5	16	40	7	3PKT 1004..	1108-M2.5x6	80-T08	2506-M8x30
AFM90-3P1004-D050-A22-Z06-H	●	50	6	22	40	7				
AFM90-3P1505-D050-A22-Z04-H	●	50	4	22	40	11	3PKT 1505..	1115-M4x10	80-T15	2508-M10x30
AFM90-3P1505-D050-A22-Z05-H	●	50	5	22	40	11				
AFM90-3P1505-D063-A22-Z04-H	●	63	4	22	40	11				
AFM90-3P1505-D063-A22-Z06-H	●	63	6	22	40	11				
AFM90-3P1505-D080-A27-Z07-H	●	80	7	27	50	11				
AFM90-3P1505-D100-A32-Z08-H	●	100	8	32	50	11				
AFM90-3P1505-D125-B40-Z10	●	125	10	40	63	11				
										2510-M12x35
										2514-M16x35
										-

TGTC Ucuna Uygun. / Compatible with TGTC Insert. / Под пластину TGTC

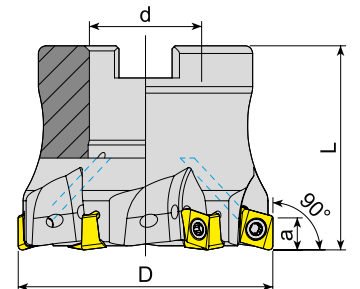

Takım Kodu Ordering Code Код для заказа	Stok Stock Наличие	Takım Ölçüleri (mm) Dimension (mm) Размеры (мм)					Kesici Uç Insert Пластина	Yedek Parçaları / Spare Parts / Запасные части		
		D	Z	d	L	a		Sıkma Vidası Screw Зажимной винт	Tork Anahtar Torx Key Торх Ключ	Montaj Vidası Mounting Screw Монтажный винт
AFM90-4N06-D040-A16-Z05-H	●	40	5	16	40	6	4NKT 0603..	1108-M3x6.8	-	2506-M8x30
AFM90-4N06-D050-A22-Z06-H	●	50	6	22	40	6				2508-M10x30

R: Sağ / Right / Правый L: Sol/Left/Левый

● Stokta / In Stock / В наличии ○ Stokta Yok / Non Stock Item / Нет в наличии

TGTC Ucuna Uygun. / Compatible with TGTC Insert. / Под пластину TGTC

Sipariş Örneği/Ordering Example/Образец заказа

1 ad./pcs./шт AFM90-3P1004-D040-A16-Z05-H

Kesme Hesabı : S 321 / Cutting Calculation : P 321 / Расчет режимов резания: стр. 321

Montaj Ölçüleri : S 318 / Mounting Reference : P 318 / Инструкция по установке фрез: стр. 318

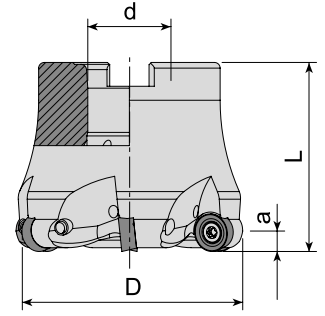

Takım Kodu Ordering Code Код для заказа	Stok Stock Наличие	Takım Ölçüleri (mm) Dimension (mm) Размеры (мм)					Kesici Uç Insert Пластина	Yedek Parçaları / Spare Parts / Запасные части				
		D	Z	d	L	a		Sıkma Vidası Screw Зажимной винт	Tork Anahtar Torx Key Торх Ключ	Montaj Vidası Mounting Screw Монтажный винт		
AFMR-RC10T3-D040-A16-Z04-H	●	40	4	16	40	5	RC.. 10T3..			2406-M8x30		
AFMR-RC10T3-D050-A22-Z05-H	●	50	5	22	50	5				4015-M4x11	80-T15	2508-M10x30
AFMR-RC10T3-D063-A22-Z06-H	●	63	6	22	50	5						

ZCC Ucuna Uygunudur. / Compatible with ZCC Insert. / Под пластину ZCC

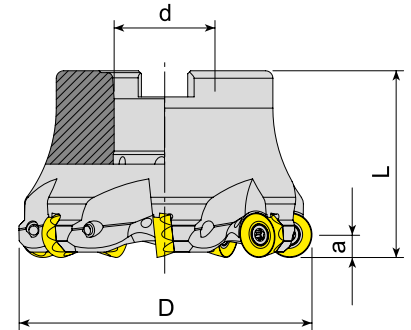

Takım Kodu Ordering Code Код для заказа	Stok Stock Наличие	Takım Ölçüleri (mm) Dimension (mm) Размеры (мм)					Kesici Uç Insert Пластина	Yedek Parçaları / Spare Parts / Запасные части				
		D	Z	d	L	a		Sıkma Vidası Screw Зажимной винт	Tork Anahtar Torx Key Торх Ключ	Montaj Vidası Mounting Screw Монтажный винт		
AFMR-RC1204-D040-A16-Z04-H	●	40	4	16	40	6	RC.. 1204..			2506-M8x30		
AFMR-RC1204-D050-A22-Z05-H	●	50	5	22	50	6				4015-M3.5x11	80-T15	2508-M10x30
AFMR-RC1204-D052-A22-Z05-H	●	52	5	22	50	6						2510-M12x35
AFMR-RC1204-D063-A22-Z06-H	●	63	6	22	50	6						
AFMR-RC1204-D063-A27-Z06-H	●	80	7	27	50	6						
AFMR-RC1204-D080-A27-Z07-H	●	80	7	27	50	6						

R: Sağ / Right / Правый L: Sol/Left/Левый

● Stokta / In Stock / В наличии ○ Stokta Yok / Non Stock Item / Нет в наличии

SNDVK Ucuna Uygunudur. / Compatible with SNDVK Insert. / Под пластину SNDVK

Sipariş Örneği/Ordering Example/Образец заказа

1 ad./pcs./шт AFMR-RC10T3-D040-A16-Z04-H

Kesme Hesabı : S 321 / Cutting Calculation : P 321 / Расчет режимов резания: стр. 321

Montaj Ölçüleri : S 318 / Mounting Reference : P 318 / Инструкция по установке фрез: стр. 318

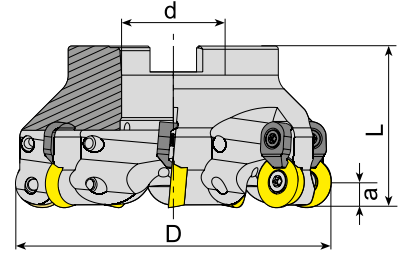

Takım Kodu Ordering Code Код для заказа	Stok Stock Наличие	Takım Ölçüleri (mm) Dimension (mm) Размеры (мм)					Kesici Uç Insert Пластина	Yedek Parçaları / Spare Parts / Запасные части					
		D	Z	d	L	a		Sıkma Vidası Screw Зажимной винт	Baskı Parçası Wedge Clamp Прижим	Baskı Vidası Clamp Screw Зажимной винт	Tork Anahtar Torx Key Торх Ключ	Montaj Vidası Mounting Screw Монтажный винт	
AFMR-RD0702-D050-A22-Z06-H	●	50	6	22	40	3.5	RD.. 0702..	3008-M2.5x6	-	-	80-T08	2407-M10x30	
AFMR-RD0803-D050-A22-Z05-H	●	50	5	22	40	4	RD.. 0803..	3008-M3x8	-	-	80-T08	2407-M10x30	
AFMRC-RD1003-D040-A16-Z04-H	●	40	4	16	40	5	RD.. 1003..					2406-M8x30	
AFMRC-RD1003-D050-A22-Z05-H	●	50	5	22	50	5						2508-M10x30	
AFMRC-RD1003-D052-A22-Z05	●	52	5	22	50	5						2510-M12x35	
AFMRC-RD1003-D063-A22-Z06-H	●	63	6	22	50	5						2514-M16x35	
AFMRC-RD1003-D080-A27-Z07-H	●	80	7	27	50	5						2510-M12x35	
AFMRC-RD1003-D100-A32-Z08-H	●	100	8	32	50	5						2514-M16x35	
AFMRC-RD10T3-D050-A22-Z05-H	●	50	5	22	50	5						RD.. 10T3..	
AFMRC-RD10T3-D063-A22-Z06-H	●	63	6	22	50	5	RD.. 12T3..	4015-M3.5x11	ACK-15	4015-M3.5x11	80-T15	2406-M8x30	
AFMRC-RD12T3-D040-A16-Z04-H	●	40	4	16	40	6						2508-M10x30	
AFMRC-RD12T3-D050-A22-Z05-H	●	50	5	22	50	6						2510-M12x35	
AFMRC-RD12T3-D052-A22-Z05-H	●	52	5	22	50	6						2514-M16x35	
AFMRC-RD12T3-D063-A22-Z06-H	●	63	6	22	50	6						-	
AFMRC-RD12T3-D080-A27-Z07-H	●	80	7	27	50	6						2406-M8x30	
AFMRC-RD12T3-D100-A32-Z08-H	●	100	8	32	50	6						2508-M10x30	
AFMRC-RD12T3-D125-B40-Z09	●	125	9	40	63	6	RD.. 1204..					-	
AFMRC-RD1204-D040-A16-Z04-H	●	40	4	16	40	6						2406-M8x30	
AFMRC-RD1204-D050-A22-Z05-H	●	50	5	22	50	6						2508-M10x30	
AFMRC-RD1204-D052-A22-Z05-H	●	52	5	22	50	6						2510-M12x35	
AFMRC-RD1204-D063-A22-Z06-H	●	63	6	22	50	6						2514-M16x35	
AFMRC-RD1204-D080-A27-Z07-H	●	80	7	27	50	6						-	
AFMRC-RD1204-D100-A32-Z07-H	●	100	7	32	50	6						2408-M10x30	
AFMRC-RD1204-D100-A32-Z08-H	●	100	8	32	50	6	RD.. 1604..	4015-M4.5x11	ACK-05	4015-M4x11		2508-M10x30	
AFMRC-RD1604-D050-A22-Z04-H	●	50	4	22	50	8						2510-M12x35	
AFMRC-RD1604-D052-A22-Z04-H	●	52	4	22	50	8						2514-M16x35	
AFMRC-RD1604-D063-A22-Z05-H	●	63	5	22	50	8						-	
AFMRC-RD1604-D066-A22-Z05-H	●	66	5	22	50	8						2408-M10x30	
AFMRC-RD1604-D066-A27-Z05-H	●	66	5	27	50	8						2508-M10x30	
AFMRC-RD1604-D080-A27-Z06-H	●	80	6	27	50	8						2510-M12x35	
AFMRC-RD1604-D100-A32-Z07-H	●	100	7	32	50	8	2514-M16x35						
AFMRC-RD1604-D125-B40-Z07	●	125	7	40	63	8						-	

R: Sağ / Right / Правый L: Sol/Left/Левый

● Stokta / In Stock / В наличии ○ Stokta Yok / Non Stock Item / Нет в наличии

ISO Uçuna Uygundur. / Compatiple with ISO Insert. / Под пластину ISO

Sipariş Örneği/Ordering Example/Образец заказа

1 ad./pcs./шт AFMR-RD0702-D050-A22-Z06-H

Kesme Hesabı : S 321 / Cutting Calculation : P 321 / Расчет режимов резания: стр. 321

Montaj Ölçüleri : S 318 / Mounting Reference : P 318 / Инструкция по установке фрез: стр. 318

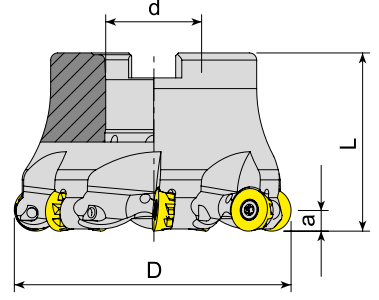

Takım Kodu Ordering Code Код для заказа	Stok Stock Наличие	Takım Ölçüleri (mm) Dimension (mm) Размеры (мм)					Kesici Uç Insert Пластина	Yedek Parçaları / Spare Parts / Запасные части		
		D	Z	d	L	a		Sıkma Vidası Screw Зажимной винт	Tork Anahtar Torx Key Торх Ключ	Montaj Vidası Mounting Screw Монтажный винт
AFMR-RP10T3-D063-A22-Z06-H	●	63	6	22	40	5	RPNX 10T3..	4010-M3x8	80-T10	2508-M10x30
AFMR-RP10T3-D080-A27-Z07-H	●	80	7	27	50	5				2510-M12x35
AFMR-RP1204-D040-A16-Z04-H	●	40	4	16	40	6	RPNX 1204..	4015-M3.5x11	80-T15	2406-M8x30
AFMR-RP1204-D080-A27-Z07-H	●	80	7	27	50	6				2510-M12x35

CRTZT Ucuna Uygundur. / Compatible with CRTZT Insert. / Под пластину CRTZT

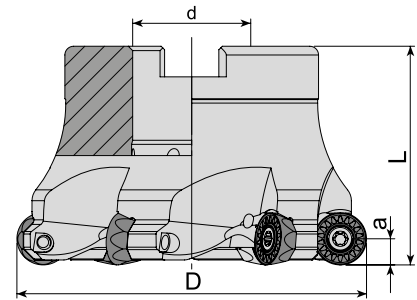

Takım Kodu Ordering Code Код для заказа	Stok Stock Наличие	Takım Ölçüleri (mm) Dimension (mm) Размеры (мм)					Kesici Uç Insert Пластина	Yedek Parçaları / Spare Parts / Запасные части		
		D	Z	d	L	a		Sıkma Vidası Screw Зажимной винт	Tork Anahtar Torx Key Торх Ключ	Montaj Vidası Mounting Screw Монтажный винт
AFMR-RP1204M-D050-A22-Z04-H	●	50	4	22	50	6	RPMT 1204..	4015-M4x11	80-T15	2508-M10x30
AFMR-RP1204M-D052-A22-Z05-H	●	52	5	22	50	6				2510-M12x35
AFMR-RP1204M-D063-A22-Z05-H	●	63	5	22	50	6				
AFMR-RP1204M-D080-A27-Z06-H	●	80	6	27	50	6				

R: Sağ / Right / Правый L: Sol/Left/Левый

● Stokta / In Stock / В наличии ○ Stokta Yok / Non Stock Item / Нет в наличии

MTSBH Ucuna Uygundur. / Compatible with MTSBH Insert. / Под пластину MTSBH

Sipariş Örneği/Ordering Example/Образец заказа

1 ad./pcs./шт AFMR-RP10T3-D063-A22-Z06-H

Kesme Hesabı : S 321 / Cutting Calculation : P 321 / Расчет режимов резания: стр. 321

Montaj Ölçüleri : S 318 / Mounting Reference : P 318 / Инструкция по установке фрез: стр. 318

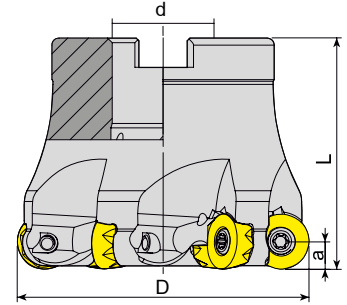

Takım Kodu Ordering Code Код для заказа	Stok Stock Наличие	Takım Ölçüleri (mm) Dimension (mm) Размеры (мм)					Kesici Uç Insert Пластина	Yedek Parçaları / Spare Parts / Запасные части		
		D	Z	d	L	a		Sıkma Vidası Screw Зажимной винт	Tork Anahtar Torx Key Торх Ключ	Montaj Vidası Mounting Screw Монтажный винт
AFMR-RY10-D040-A16-Z04-H	●	40	4	16	40	5	RYMX 1004..	4015-M3.5x11	80-T15	2406-M8x30
AFMR-RY10-D040-A16-Z05-H	●	40	5	16	40	5				2506-M8x30
AFMR-RY10-D050-A22-Z05-H	●	50	5	22	50	5				2508-M10x30
AFMR-RY10-D063-A22-Z06-H	●	63	6	22	50	5				2406-M8x30
AFMR-RY12-D040-A16-Z04-H	●	40	4	16	40	6	RYMX 1205..	4015-M4x11	80-T15	2406-M8x30
AFMR-RY12-D050-A22-Z05-H	●	50	5	22	50	6				2508-M10x30
AFMR-RY12-D052-A22-Z05-H	●	52	5	22	50	6				2510-M12x35
AFMR-RY12-D063-A22-Z06-H	●	63	6	22	50	6				2514-M16x35
AFMR-RY12-D080-A27-Z06-H	●	80	6	27	50	6				
AFMR-RY12-D100-A32-Z07-H	●	100	7	32	50	6				

TGTC Uçuna Uygundur. / Compatible with TGTC Insert. / Под пластину TGTC

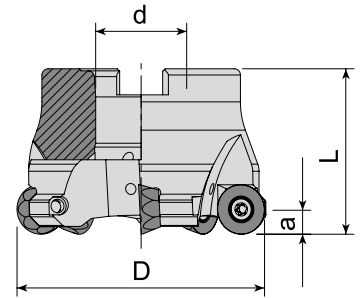

Takım Kodu Ordering Code Код для заказа	Stok Stock Наличие	Takım Ölçüleri (mm) Dimension (mm) Размеры (мм)					Kesici Uç Insert Пластина	Yedek Parçaları / Spare Parts / Запасные части		
		D	Z	d	L	a		Sıkma Vidası Screw Зажимной винт	Tork Anahtar Torx Key Торх Ключ	Montaj Vidası Mounting Screw Монтажный винт
AFMR-QP10T3-D040-A16-Z04-H	●	40	4	16	40	5	QP.. 10T3..	4015-M3.5x11	80-T15	2506-M8x30
AFMR-QP10T3-D050-A22-Z05-H	●	50	5	22	40	5				2407-M10x30
AFMR-QP10T3-D063-A22-Z06-H	●	63	6	22	40	5				
AFMR-QP1204-D050-A22-Z04-H	●	50	4	22	40	6	QP.. 1204..	4015-M4x11	80-T15	
AFMR-QP1204-D063-A22-Z05-H	●	63	5	22	40	6				

R: Sağ / Right / Правый L: Sol/Left/Левый
● Stokta / In Stock / В наличии ○ Stokta Yok / Non Stock Item / Нет в наличии
SMTM Uçuna Uygundur. / Compatible with SMTM Insert. / Под пластину SMTM

Sipariş Örneği/Ordering Example/Образец заказа
1 ad./pcs./шт AFMR-RY10-D040-A16-Z04-H
Kesme Hesabı : S 321 / Cutting Calculation : P 321 / Расчет режимов резания: стр. 321
Montaj Ölçüleri : S 318 / Mounting Reference : P 318 / Инструкция по установке фрез: стр. 318

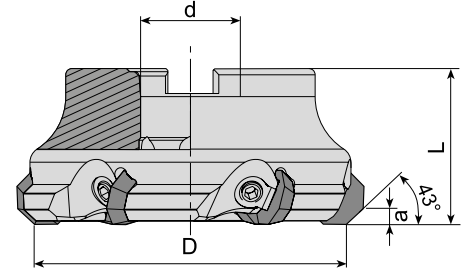

Takım Kodu Ordering Code Код для заказа	Stok Stock Наличие	Takım Ölçüleri (mm) Dimension (mm) Размеры (мм)					Kesici Uç Insert Пластина	Yedek Parçaları / Spare Parts / Запасные части			
		D	Z	d	L	a		Baskı Pabucu Wedge Clamp Прижим	Baskı Vidası Clamp Screw Винт прижима	Anahtar Allen Key Ключ	Montaj Vidası Mounting Screw Монтажный винт
AFM43C-OF07-D063-A22-Z04	●	63	4	22	45	5	OF.. 0704..	ACK-11	AKV-15-M8x1x20	AAL-05-4	2508-M10x30
AFM43C-OF07-D080-A27-Z05	●	80	5	27	50	5					2510-M12x35
AFM43C-OF07-D100-A32-Z06	●	100	6	32	50	5					2514-M16x35
AFM43C-OF07-D125-B40-Z08	●	125	8	40	63	5					-
AFM43C-OF07-D160-C40-Z09	●	160	9	40	63	5					-

ISO Ucuna Uygun. / Compatible with ISO Insert. / Под пластину ISO

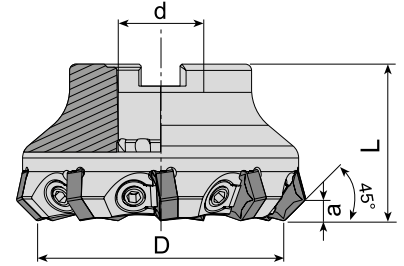

Takım Kodu Ordering Code Код для заказа	Stok Stock Наличие	Takım Ölçüleri (mm) Dimension (mm) Размеры (мм)					Kesici Uç Insert Пластина	Yedek Parçaları / Spare Parts / Запасные части			
		D	Z	d	L	a		Baskı Pabucu Wedge Clamp Прижим	Baskı Vidası Clamp Screw Винт прижима	Anahtar Allen Key Ключ	Montaj Vidası Mounting Screw Монтажный винт
AFM45C-HN0905-D063-A22-Z07	●	63	7	22	40	4.5	HN.. 0905..	ACK-11	AKV-15-M8x1x20	AAL-05-4	2508-M10x30
AFM45C-HN0905-D080-A27-Z09	●	80	9	27	50	4.5					2510-M12x35
AFM45C-HN0905-D100-A32-Z11	●	100	11	32	50	4.5					2514-M16x35
AFM45C-HN0905-D125-B40-Z13	●	125	13	40	63	4.5					-
AFM45CL-HN0905-D125-B40-Z10	●	125	10	40	63	4.5					-
AFM45C-HN0905-D160-C40-Z15	●	160	15	40	63	4.5					-

R: Sağ / Right / Правый L: Sol/Left/ Левый

● Stokta / In Stock / В наличии ○ Stokta Yok / Non Stock Item / Нет в наличии

WDA-KNMTL Ucuna Uygun. / Compatible with WDA-KNMTL Insert. / Под пластину WDA-KNMTL



Sipariş Örneği/Ordering Example/Образец заказа

1 ad./pcs./шт AFM43C-OF07-D063-A22-Z04

Kesme Hesabı : S 321 / Cutting Calculation : P 321 / Расчет режимов резания: стр. 321

Montaj Ölçüleri : S 318 / Mounting Reference : P 318 / Инструкция по установке фрез: стр. 318



45°

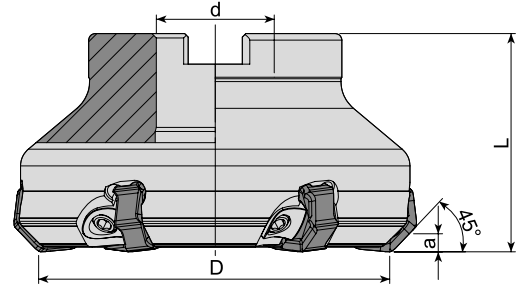

Takım Kodu Ordering Code Код для заказа	Stok Stock Наличие	Takım Ölçüleri (mm) Dimension (mm) Размеры (мм)					Kesici Uç Insert Пластина	Yedek Parçaları / Spare Parts / Запасные части			
		D	Z	d	L	a		Baskı Pabucu Wedge Clamp Прижим	Baskı Vidası Clamp Screw Винт прижима	Anahtar Allen Key Ключ	Montaj Vidası Mounting Screw Монтажный винт
AFM45C-XN0806-D063-A22-Z05	●	63	5	22	50	4.5	XNMU 0806..	ACK-26	AKV-26-M6x0.75x20	AAL-03-03	2508-M10x30
AFM45C-XN0806-D080-A27-Z06	●	80	6	27	50	4.5					2510-M12x35
AFM45C-XN0806-D100-A32-Z08	●	100	8	32	50	4.5					2514-M16x35
AFM45C-XN0806-D125-B40-Z08	●	125	8	40	63	4.5					-
AFM45C-XN0806-D160-C40-Z10	●	160	10	40	63	4.5					-
AFM45C-XN0806-D200-C60-Z12	●	200	12	60	63	4.5					-

DJT Ucuna Uygun. / Compatible with DJT Insert. / Под пластину DJT

75°

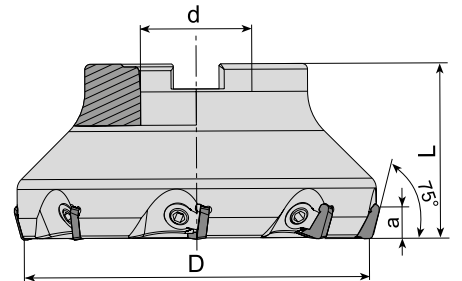

Takım Kodu Ordering Code Код для заказа	Stok Stock Наличие	Takım Ölçüleri (mm) Dimension (mm) Размеры (мм)					Kesici Uç Insert Пластина	Yedek Parçaları / Spare Parts / Запасные части			
		D	Z	d	L	a		Baskı Pabucu Wedge Clamp Прижим	Baskı Vidası Clamp Screw Винт прижима	Anahtar Allen Key Ключ	Montaj Vidası Mounting Screw Монтажный винт
AFM75C-SP12-D050-A22-Z04	●	50	4	22	42	8	SPKN 1203..	ACK-10	AKV-22-M8x1x14	AAL-05-4	2508-M10x30
AFM75C-SP12-D063-A22-Z05	●	63	5	22	40	8					2510-M12x35
AFM75C-SP12-D080-A27-Z06	●	80	6	27	50	8					2514-M16x35
AFM75C-SP12-D100-A32-Z07	●	100	7	32	50	8					-
AFM75C-SP12-D125-B40-Z08	●	125	8	40	63	8					-
AFM75C-SP12-D160-C40-Z09	●	160	9	40	63	8					-
AFM75C-SP12-D200-C60-Z12	●	200	12	60	63	8	-				

R: Sağ / Right / Правый L: Sol/Left/Левый

● Stokta / In Stock / В наличии ○ Stokta Yok / Non Stock Item / Нет в наличии

ISO Ucuna Uygun. / Compatible with ISO Insert. / Под пластину ISO

Sipariş Örneği/Ordering Example/Образец заказа

1 ad./pcs./шт AFM45C-XN0806-D063-A22-Z05

Kesme Hesabı : S 321 / Cutting Calculation : P 321 / Расчет режимов резания: стр. 321

Montaj Ölçüleri : S 318 / Mounting Reference : P 318 / Инструкция по установке фрез: стр. 318

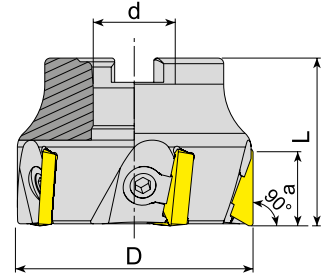

Takım Kodu Ordering Code Код для заказа	Stok Stock Наличие	Takım Ölçüleri (mm) Dimension (mm) Размеры (мм)					Kesici Uç Insert Пластина	Yedek Parçaları / Spare Parts / Запасные части			
		D	Z	d	L	a		Baskı Pabucu Wedge Clamp Прижим	Baskı Vidası Clamp Screw Винт прижима	Anahtar Allen Key Ключ	Montaj Vidası Mounting Screw Монтажный винт
AFM90C-TP16-D050-A22-Z04	●	50	4	22	40	12	TP.. 1603..	ACK-10	AKV-22-M8x14 AKV-13-M8x16	AAL-05-4	2407-M10x30
AFM90C-TP16-D063-A22-Z06	●	63	6	22	45	12					2508-M10x30
AFM90C-TP16-D080-A27-Z07	●	80	7	27	50	12					2510-M12x35
AFM90C-TP16-D100-A32-Z08	●	100	8	32	50	12					2514-M16x35
AFM90C-TP16-D125-B40-Z08	●	125	8	40	63	12					-
AFM90C-TP22-D063-A22-Z05	●	63	5	22	45	18	TP.. 2204..	ACK-11	AKV-14-M8x1x18	AAL-05-4	2508-M10x30
AFM90C-TP22-D080-A27-Z06	●	80	6	27	50	18					2510-M12x35
AFM90C-TP22-D100-A32-Z07	●	100	7	32	50	18					2514-M16x35
AFM90C-TP22-D125-B40-Z08	●	125	8	40	63	18					-
AFM90C-TP22-D160-C40-Z09	●	160	9	40	63	18					-
AFM90C-TP22-D200-C60-Z12	●	200	12	60	63	18					-
AFM90C-TP22-D250-C60-Z15	●	250	15	60	63	18					-
AFM90C-TP22-D315-D60-Z18	●	315	18	60	63	18	-				

R: Sağ / Right / Правый L: Sol/Left/Левый
● Stokta / In Stock / В наличии ○ Stokta Yok / Non Stock Item / Нет в наличии
ISO Ucuna Uygunudur. / Compatible with ISO Insert. / Под пластину ISO

Sipariş Örneği/Ordering Example/Образец заказа
1 ad./pcs./шт AFM90C-TP16-D050-A22-Z04
Kesme Hesabı : S 321 / Cutting Calculation : P 321 / Расчет режимов резания: стр. 321
Montaj Ölçüleri : S 318 / Mounting Reference : P 318 / Инструкция по установке фрез: стр. 318



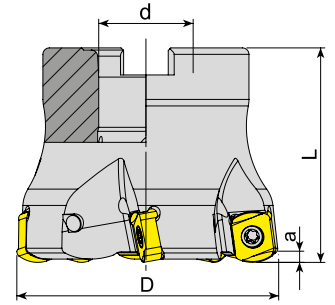

Takım Kodu Ordering Code Код для заказа	Stok Stock Наличие	Takım Ölçüleri (mm) Dimension (mm) Размеры (мм)					Kesici Uç Insert Пластина	Yedek Parçaları / Spare Parts / Запасные части		
		D	Z	d	L	a		Sıkma Vidası Screw Зажимной винт	Tork Anahtar Torx Key Торх Ключ	Montaj Vidası Mounting Screw Монтажный винт
AHFM-BL0904-D040-A16-Z05-H	●	40	5	16	40	2	BLMP 0904..		80-T10	2506-M8x30
AHFM-BL0904-D050-A22-Z06-H	●	50	6	22	50	2				2508-M10x30
AHFM-BL0904-D063-A22-Z05-H	●	63	5	22	50	2				
AHFM-BL0904-D063-A22-Z07-H	●	63	7	22	50	2				

TGTC Ucuna Uygundur. / Compatible with TGTC Insert. / Под пластину TGTC

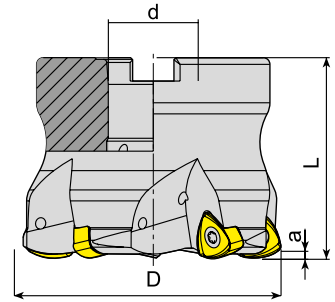

Takım Kodu Ordering Code Код для заказа	Stok Stock Наличие	Takım Ölçüleri (mm) Dimension (mm) Размеры (мм)					Kesici Uç Insert Пластина	Yedek Parçaları / Spare Parts / Запасные части		
		D	Z	d	L	a		Sıkma Vidası Screw Зажимной винт	Tork Anahtar Torx Key Торх Ключ	Montaj Vidası Mounting Screw Монтажный винт
AHFM-BL1205-D050-A22-Z03-H	●	50	3	22	40	2	BLMP 1205..		80-T15	2508-M10x30
AHFM-BL1205-D063-A22-Z04-H	●	63	4	22	40	2				2510-M12x35
AHFM-BL1205-D080-A27-Z05-H	●	80	5	27	50	2				

R: Sağ / Right / Правый L: Sol/Left/Левый
● Stokta / In Stock / В наличии ○ Stokta Yok / Non Stock Item / Нет в наличии
TGTC Ucuna Uygundur. / Compatible with TGTC Insert. / Под пластину TGTC

Sipariş Örneği/Ordering Example/Образец заказа
1 ad./pcs./шт AHFM-BL0904-D040-A16-Z05-H
Kesme Hesabı : S 321 / Cutting Calculation : P 321 / Расчет режимов резания: стр. 321
Montaj Ölçüleri : S 318 / Mounting Reference : P 318 / Инструкция по установке фрез: стр. 318

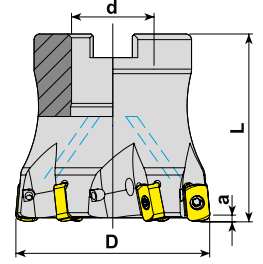

Takım Kodu Ordering Code Код для заказа	Stok Stock Наличие	Takım Ölçüleri (mm) Dimension (mm) Размеры (мм)					Kesici Uç Insert Пластина	Yedek Parçaları / Spare Parts / Запасные части		
		D	Z	d	L	a		Sıkma Vidası Screw Зажимной винт	Tork Anahtar Torx Key Торх Ключ	Montaj Vidası Mounting Screw Монтажный винт
AHFM-EN1004-D050-A22-Z05-H	●	50	5	22	50	1	ENMU 1004..	3008-M2.5X6	80-T08	2508-M10x30
AHFM-EN1004-D050-A22-Z06-H	●	50	6	22	50	1				
AHFM-EN1004-D052-A22-Z06-H	●	52	6	22	50	1				
AHFM-EN1004-D063-A22-Z06-H	●	63	6	22	50	1				

DJT Ucuna Uygunur. / Compatiple with DJT Insert. / Под пластину DJT

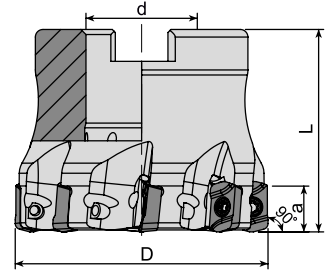

Takım Kodu Ordering Code Код для заказа	Stok Stock Наличие	Takım Ölçüleri (mm) Dimension (mm) Размеры (мм)					Kesici Uç Insert Пластина	Yedek Parçaları / Spare Parts / Запасные части		
		D	Z	d	L	a		Sıkma Vidası Screw Зажимной винт	Tork Anahtar Torx Key Торх Ключ	Montaj Vidası Mounting Screw Монтажный винт
AHFM-EP1003-D050-A22-Z08-H	●	50	8	22	40	1	EP.. 1003.. ZPMT 1003.. YPHW 1003..	3008-M2.5X6	80-T08	2508-M10x30
AHFM-EP1003-D063-A22-Z08-H	●	63	8	22	40	1				

R: Sağ / Right / Правый L: Sol/Left/Левый
● Stokta / In Stock / В наличии ○ Stokta Yok / Non Stock Item / Нет в наличии
DJT Ucuna Uygunur. / Compatiple with DJT Insert. / Под пластину DJT

Sipariş Örneği/Ordering Example/Образец заказа
1 ad./pcs./шт AHFM-EN1004-D050-A22-Z05-H

Kesme Hesabı : S 321 / Cutting Calculation : P 321 / Расчет режимов резания: стр. 321
Montaj Ölçüleri : S 318 / Mounting Reference : P 318 / Инструкция по установке фрез: стр. 318

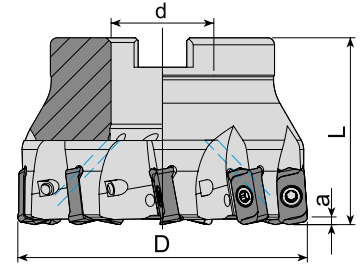

Takım Kodu Ordering Code Код для заказа	Stok Stock Наличие	Takım Ölçüleri (mm) Dimension (mm) Размеры (мм)					Kesici Uç Insert Пластина	Yedek Parçaları / Spare Parts / Запасные части				
		D	Z	d	L	a		Sıkma Vidası Screw Зажимной винт	Tork Anahtar Torx Key Торх Ключ	Montaj Vidası Mounting Screw Монтажный винт		
AHFM-L003-D040-A16-Z06-H	●	40	6	16	40	1	LOGU 0303..			2506-M8x30		
AHFM-L003-D050-A22-Z07-H	●	50	7	22	40	1				1108-M3x6.8	80-T08	2508-M10x30
AHFM-L003-D063-A22-Z09-H	●	63	9	22	40	1						

KYCR Ucuna Uygun. / Compatible with KYCR Insert. / Под пластину KYCR

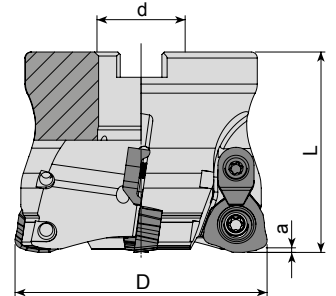

Takım Kodu Ordering Code Код для заказа	Stok Stock Наличие	Takım Ölçüleri (mm) Dimension (mm) Размеры (мм)					Kesici Uç Insert Пластина	Yedek Parçaları / Spare Parts / Запасные части					
		D	Z	d	L	a		Sıkma Vidası Screw Зажимной винт	Baskı Pabucu Wedge Clamp Прижим	Baskı Vidası Clamp Screw Винт прижима	Tork Anahtar Torx Key Торх Ключ	Montaj Vidası Mounting Screw Монтажный винт	
AHFMC-JD1204-D052-A22-Z03-H	●	52	3	22	50	1.5	JDMW 1204..	4615-M4x11		ACK-05	4015-M4x11		2508-M10x30
AHFMC-JD1204-D052-A22-Z04-H	●	52	4	22	50	1.5							
AHFMC-JD1405-D052-A22-Z03-H	●	52	3	22	40	2	JDMW 1405..	1020-M5x11					2408-M10x30
AHFMC-JD1405-D063-A22-Z04-H	●	63	4	22	40	2							2508-M10x30

R: Sağ / Right / Правый L: Sol/Left/Левый

● Stokta / In Stock / В наличии ○ Stokta Yok / Non Stock Item / Нет в наличии

MTSBH Ucuna Uygun. / Compatible with MTSBH Insert. / Под пластину MTSBH

Sipariş Örneği/Ordering Example/Образец заказа

1 ad./pcs./шт AHFM-L003-D040-A16-Z06-H

Kesme Hesabı : S 321 / Cutting Calculation : P 321 / Расчет режимов резания: стр. 321

Montaj Ölçüleri : S 318 / Mounting Reference : P 318 / Инструкция по установке фрез: стр. 318

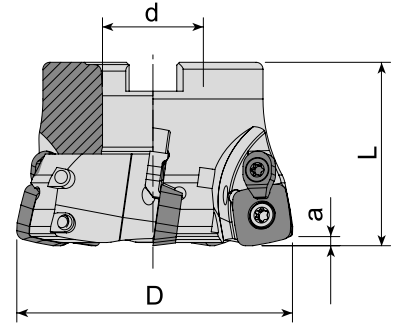

Takım Kodu Ordering Code Код для заказа	Stok Stock Наличие	Takım Ölçüleri (mm) Dimension (mm) Размеры (мм)					Kesici Uç Insert Пластина	Yedek Parçaları / Spare Parts / Запасные части					
		D	Z	d	L	a		Sıkma Vidası Screw Зажимной винт	Baskı Pabucu Wedge Clamp Прижим	Baskı Vidası Clamp Screw Винт прижима	Tork Anahtar Torx Key Торх Ключ	Montaj Vidası Mounting Screw Монтажный винт	
AHFMC-SD1204-D050-A22-Z04-H	●	50	4	22	40	1.8	SD.. 1204..						2508-M10x30
AHFMC-SD1204-D063-A22-Z05-H	●	63	5	22	40	1.8							2510-M12x35
AHFMC-SD1204-D080-A27-Z06-H	●	80	6	27	50	1.8							2514-M16x35
AHFMC-SD1204-D100-A32-Z08-H	●	100	8	32	50	1.8							

ZCC Ucuna Uygunur. / Compatible with ZCC Insert. / Под пластину ZCC

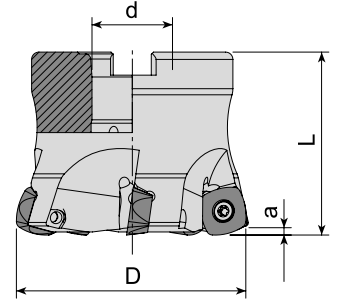

Takım Kodu Ordering Code Код для заказа	Stok Stock Наличие	Takım Ölçüleri (mm) Dimension (mm) Размеры (мм)					Kesici Uç Insert Пластина	Yedek Parçaları / Spare Parts / Запасные части					
		D	Z	d	L	a		Sıkma Vidası Screw Зажимной винт	Tork Anahtar Torx Key Торх Ключ	Montaj Vidası Mounting Screw Монтажный винт			
AHFM-SD1205-D052-A22-Z04-H	●	52	4	22	50	2	SD.. 1205..						2508-M10x30
AHFM-SD1205-D052-A22-Z05-H	●	52	5	22	50	2							2510-M12x35
AHFM-SD1205-D066-A22-Z05-H	●	66	5	22	50	2							
AHFM-SD1205-D066-A22-Z06-H	●	66	6	22	50	2							
AHFM-SD1205-D080-A27-Z06-H	●	80	6	27	70	2							

R: Sağ / Right / Правый L: Sol/Left/Левый
● Stokta / In Stock / В наличии ○ Stokta Yok / Non Stock Item / Нет в наличии
HTCH Ucuna Uygunur. / Compatible with HTCH Insert. / Под пластину HTCH

Sipariş Örneği/Ordering Example/Образец заказа
1 ad./pcs./шт AHFMC-SD1204-D050-A22-Z04-H
Kesme Hesabı : S 321 / Cutting Calculation : P 321 / Расчет режимов резания: стр. 321
Montaj Ölçüleri : S 318 / Mounting Reference : P 318 / Инструкция по установке фрез: стр. 318

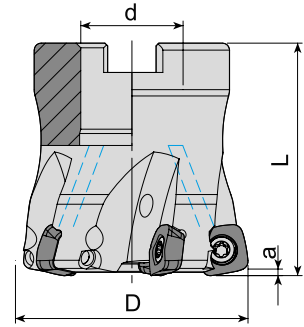

Takım Kodu Ordering Code Код для заказа	Stok Stock Наличие	Takım Ölçüleri (mm) Dimension (mm) Размеры (мм)					Kesici Uç Insert Пластина	Yedek Parçaları / Spare Parts / Запасные части		
		D	Z	d	L	a		Sıkma Vidası Screw Зажимной винт	Tork Anahtar Torx Key Торх Ключ	Montaj Vidası Mounting Screw Монтажный винт
AHFM-SO1004-D050-A22-Z05-H	●	50	5	22	50	1.5	SOMT 1004..			
AHFM-SO1004-D063-A22-Z06-H	●	63	6	22	50	1.5				
AHFM-SO1004-D080-A27-Z07-H	●	80	7	27	63	1.5				

KYCR Ucuna Uygunudur. / Compatible with KYCR Insert. / Под пластину KYCR

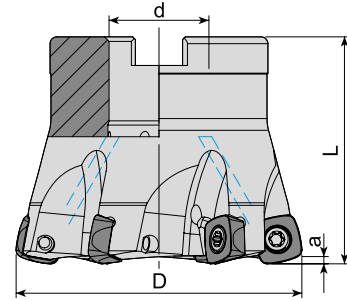

Takım Kodu Ordering Code Код для заказа	Stok Stock Наличие	Takım Ölçüleri (mm) Dimension (mm) Размеры (мм)					Kesici Uç Insert Пластина	Yedek Parçaları / Spare Parts / Запасные части		
		D	Z	d	L	a		Sıkma Vidası Screw Зажимной винт	Tork Anahtar Torx Key Торх Ключ	Montaj Vidası Mounting Screw Монтажный винт
AHFM-SP1004-D050-A22-Z05-H	●	50	5	22	50	1.5	SPNW 1004..			
AHFM-SP1004-D052-A22-Z05-H	●	52	5	22	50	1.5				
AHFM-SP1004-D063-A22-Z06-H	●	63	6	22	50	1.5				

R: Sağ / Right / Правый L: Sol/Left/Левый

● Stokta / In Stock / В наличии ○ Stokta Yok / Non Stock Item / Нет в наличии

DJT Ucuna Uygunudur. / Compatible with DJT Insert. / Под пластину DJT

Sipariş Örneği/Ordering Example/Образец заказа

1 ad./pcs./шт AHFM-SO1004-D050-A22-Z05-H

Kesme Hesabı : S 321 / Cutting Calculation : P 321 / Расчет режимов резания: стр. 321

Montaj Ölçüleri : S 318 / Mounting Reference : P 318 / Инструкция по установке фрез: стр. 318

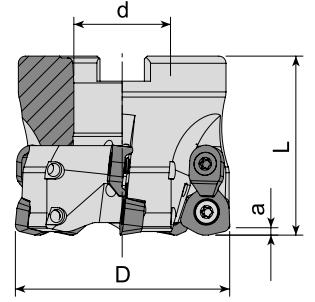

Takım Kodu Ordering Code Код для заказа	Stok Stock Наличие	Takım Ölçüleri (mm) Dimension (mm) Размеры (мм)					Kesici Uç Insert Пластина	Yedek Parçaları / Spare Parts / Запасные части				
		D	Z	d	L	a		Sıkma Vidası Screw Зажимной винт	Baskı Pabucu Wedge Clamp Прижим	Baskı Vidası Clamp Screw Винт прижима	Tork Anahtar Torx Key Торх Ключ	Montaj Vidası Mounting Screw Монтажный винт
AHFMC-WD06T3D-D042-A16-Z04-H	●	42	4	16	45	1.5	WD.W 06T3..	3015-M3.5x9	ACK-15	4015-M3.5x11	80-T15	2506-M8x30
AHFMC-WD06T3D-D050-A22-Z05-H	●	50	5	22	50	1.5						
AHFMC-WD06T3D-D052-A22-Z05-H	●	52	5	22	50	1.5						
AHFMC-WD0805D-D052-A22-Z04-H	●	52	4	22	50	2	WD.W 0805..	4020-M4.5x12	ACK-19	4020-M4.5x12	80-T20	2508-M10x30
AHFMC-WD0805D-D063-A22-Z05-H	●	63	5	22	50	2						
AHFMC-WD0805D-D063-A27-Z05-H	●	63	5	27	50	2						
AHFMC-WD0805D-D066-A27-Z05-H	●	66	5	27	50	2						
AHFMC-WD0805D-D080-A27-Z05	●	80	5	27	50	2						
AHFMC-WD0805D-D100-A32-Z06	●	100	6	32	50	2						
AHFMC-WD10X6D-D125-B40-Z06	●	125	6	40	63	2.5	WD.W 10X6..					2510-M12x35
AHFMC-WD10X6D-D160-C40-Z07	●	160	7	40	63	2.5						

DJT Ucuna Uygundur. / Compatible with DJT Insert. / Под пластину DJT

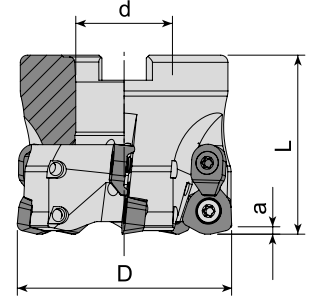

Takım Kodu Ordering Code Код для заказа	Stok Stock Наличие	Takım Ölçüleri (mm) Dimension (mm) Размеры (мм)					Kesici Uç Insert Пластина	Yedek Parçaları / Spare Parts / Запасные части				
		D	Z	d	L	a		Sıkma Vidası Screw Зажимной винт	Baskı Pabucu Wedge Clamp Прижим	Baskı Vidası Clamp Screw Винт прижима	Tork Anahtar Torx Key Торх Ключ	Montaj Vidası Mounting Screw Монтажный винт
AHFMC-WD0804-D040-A16-Z04-H	●	40	4	16	40	-	WDMT 0804..	4010-M3x8	ACK-15	4010-M3x8	80-T10	2506-M8x30
AHFMC-WD0804-D050-A22-Z04-H	●	50	4	22	50	-						
AHFMC-WD1205-D050-A22-Z04-H	●	50	4	22	50	-	WDMT 1205..	1415-M4x11	ACK-05	4015-M4x11	80-T15	2508-M10x30
AHFMC-WD1205-D052-A22-Z04-H	●	52	4	22	50	-						
AHFMC-WD1205-D063-A22-Z05-H	●	63	5	22	50	-						
AHFMC-WD1205-D080-A27-Z06-H	●	80	6	27	63	-						

R: Sağ / Right / Правый L: Sol/Left/Левый

● Stokta / In Stock / В наличии ○ Stokta Yok / Non Stock Item / Нет в наличии

SMTM Ucuna Uygundur. / Compatible with SMTM Insert. / Под пластину SMTM



Sipariş Örneği/Ordering Example/Образец заказа

1 ad./pcs./шт AHFMC-WD06T3D-D042-A16-Z04-H

Kesme Hesabı : S 321 / Cutting Calculation : P 321 / Расчет режимов резания: стр. 321

Montaj Ölçüleri : S 318 / Mounting Reference : P 318 / Инструкция по установке фрез: стр. 318

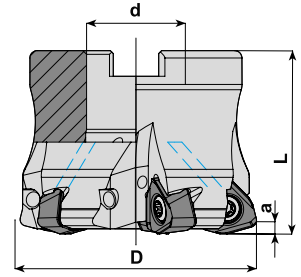

Takım Kodu Ordering Code Код для заказа	Stok Наличие	Takım Ölçüleri (mm) Dimension (mm) Размеры (мм)					Kesici Uç Insert Пластина	Yedek Parçaları / Spare Parts / Запасные части			
		D	Z	d	L	a		Sıkma Vidası Screw Зажимной винт	Tork Anahtar Torx Key Торх Ключ	Montaj Vidası Mounting Screw Монтажный винт	
AHFM-WN0907-D050-A22-Z04-H	●	50	4	22	50	3					
AHFM-WN0907-D052-A22-Z04-H	●	52	4	22	50	3					
AHFM-WN0907-D063-A22-Z05-H	●	63	5	22	50	3					
AHFM-WN0907-D066-A27-Z05-H	●	66	5	27	50	3					
AHFM-WN0907-D080-A27-Z06-H	●	80	6	27	50	3					
AHFM-WN0907-D100-A32-Z07-H	●	100	7	32	50	3					

DJT Ucuna Uygunudur. / Compatible with DJT Insert. / Под пластину DJT

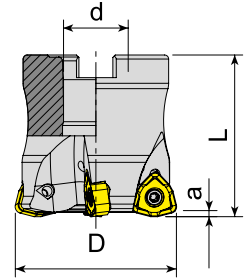

Takım Kodu Ordering Code Код для заказа	Stok Наличие	Takım Ölçüleri (mm) Dimension (mm) Размеры (мм)					Kesici Uç Insert Пластина	Yedek Parçaları / Spare Parts / Запасные части			
		D	Z	d	L	a		Sıkma Vidası Screw Зажимной винт	Tork Anahtar Torx Key Торх Ключ	Montaj Vidası Mounting Screw Монтажный винт	
AHFM-WN09T3-D040-A16-Z04-H	●	40	4	16	40	1.5					
AHFML-WN09T3-D040-A16-Z04-H	●	40	4	16	40	1.5					
AHFM-WN09T3-D050-A22-Z05-H	●	50	5	22	40	1.5					
AHFML-WN09T3-D050-A22-Z05-H	●	50	5	22	40	1.5					
AHFM-WN09T3-D063-A22-Z06-H	●	63	6	22	40	1.5					

R: Sağ / Right / Правый L: Sol/Left/Левый
● Stokta / In Stock / В наличии ○ Stokta Yok / Non Stock Item / Нет в наличии
KRLY Ucuna Uygunudur. / Compatible with KRLY Insert. / Под пластину KRLY

Sipariş Örneği/Ordering Example/Образец заказа
1 ad./pcs./шт AHFM-WN0907-D050-A22-Z04-H
Kesme Hesabı : S 321 / Cutting Calculation : P 321 / Расчет режимов резания: стр. 321
Montaj Ölçüleri : S 318 / Mounting Reference : P 318 / Инструкция по установке фрез: стр. 318

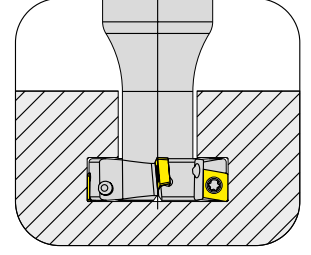
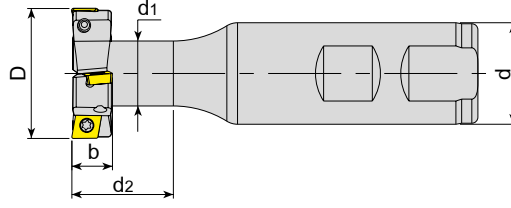

Takım Kodu
Ordering Code
Код для заказа

Takım Kodu Ordering Code Код для заказа	Stok Stock Наличие	Takım Ölçüleri (mm) Dimension (mm) Размеры (мм)								Kesici Uç Insert Пластина	Yedek Parçaları / Spare Parts / Залпасные части	
		Z		D	b	d	L	d ₁	d ₂		Sıkma Vidası Screw Зажимной винт	Tork Anahtar Torx Key Торх Ключ
		Toplam Total Общее	Etkili Effective Эффективное									
ATSM90-CC06-D17X8-W16-L85-Z02	●	2	1	17	8	16	85	10	16	CC.. 0602..	3008-M2.5x6	80-T08
ATSM90-CC06-D32X8-W25-L100-Z04	●	4	2	32	8	25	100	16	23			
ATSM90-CC06-D28X8-W20-L66-Z04	●	4	2	28	8	20	66	14	15.5			
ATSM90-CC06-D45.5X8-W25-L100-Z06	●	6	3	45.5	8	25	100	12	30			
ATSM90-CC06-D63X8-W32-L125-Z08	●	8	4	63	8	32	125	31.5	30			
ATSM90-CC06-D18X9-W16-L90-Z02	●	2	1	18	9	16	90	10	16			
ATSM90-CC06-D20X9-W16-L85-Z04	●	4	2	20	9	16	85	10	16			
ATSM90-CC06-D23X10-W20-L90-Z04	●	4	2	23	10	20	90	12	25			
ATSM90-CC06-D32X10-W25-L100-Z04	●	4	2	32	10	25	100	16	25			
ATSM90-CC06-D45X10-W32-L120-Z06	●	6	3	45	10	32	120	20	25			
ATSM90-CC06-D25X11-W25-L100-Z04	●	4	2	25	11	25	100	13	20	CC.. 09T3..	4015-M3.5x9	80-T15
ATSM90-CC09-D30X12-W25-L100-Z04	●	4	2	30	12	25	100	16	25			
ATSM90-CC09-D32X12-W25-L100-Z02	●	2	1	32	12	25	100	16	25			
ATSM90-CC09-D32X12-W25-L100-Z04	●	4	2	32	12	25	100	16	25			
ATSM90-CC09-D32X14-W25-L100-Z04	●	4	2	32	14	25	100	16	25			
ATSM90-CC09-D37X16-W32-L120-Z04	●	4	2	37	16	32	120	17	30			
ATSM90-CC09-D42X17-W32-L120-Z04	●	4	2	42	17	32	120	19	30			
ATSM90-CC09-D40X17-W32-L120-Z04-H	●	4	2	40	17	32	120	19	30			
ATSM90-CC12-D47X20-W32-L120-Z04	●	4	2	47	20	32	120	25	45			
ATSM90-CC12-D52X21-W32-L120-Z04	●	4	2	52	21	32	120	25	45			
ATSM90-CC12-D50X22-W32-L120-Z04	●	4	2	50	22	32	120	25	45	CC.. 1204..	1020-M5x11	80-T20
ATSM90-CC12-D55X22-W32-L120-Z04	●	4	2	55	22	32	120	25	45			

R: Sağ / Right / Правый L: Sol/Left/Левый

● Stokta / In Stock / В наличии ○ Stokta Yok / Non Stock Item / Нет в наличии

Sipariş Örneği/Ordering Example/Образец заказа

1 ad./pcs./шт. ATSM90-CC06-D17X8-W16-L85-Z02

Kesme Hesabı : S 321 / Cutting Calculation : P 321 / Расчет режимов резания : стр. 321



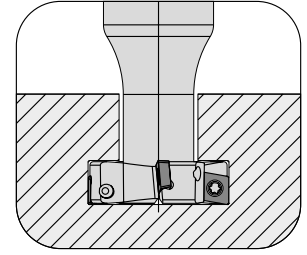
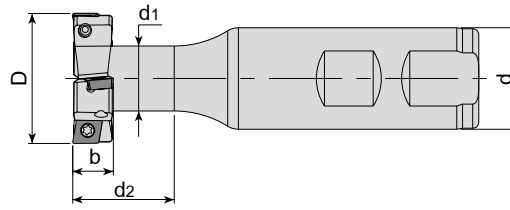

Takım Kodu
Ordering Code
Код для заказа

Stok Stock Наличие	Z		Takım Ölçüleri (mm) Dimension (mm) Размеры (мм)						Kesici Uç Insert Пластина	Yedek Parçaları / Spare Parts / Запасные части		
	Toplam Total Общее	Etkili Effective Эффективное	D	b	d	L	d ₁	d ₂		Sıkma Vidası Screw Зажимной винт	Tork Anahtar Torx Key Торх Ключ	
ATSM90-SP..05-D22.5X5-W25-L100-Z04	●	4	2	22.5	5	25	100	12	25	SPMG 050204 TGTC UCUNA UYGUNDUR. FOR TGTC INSERT. Под пластину TGTC	3006-M2x4	80-T06
ATSM90-SP..05-D30X5-W25-L100-Z04	●	4	2	30	5	25	100	10	25			
ATSM90-SPGT0502-D63X6-W32-L125-Z10	●	10	5	63	6	32	125	31	30	SPGT 050204		
ATSM90-SPGT0904-D32X14-W32-L120-Z04-H	●	4	2	32	14	32	120	17.5	30	SPGT 090408 ZCC UCUNA UYGUNDUR. FOR ZCC INSERT. Под пластину ZCC	4015-M3.5x9	80-T15
ATSM90-SPGT0904-D37X16-W32-L120-Z04-H	●	4	2	37	16	32	120	21	40			
ATSM90-SPGT0904-D42X17-W32-L120-Z04-H	●	4	2	42	17	32	120	21	40			
ATSM90-SPGT1104-D47X20-W32-L120-Z04-H	●	4	2	47	20	32	120	24	45	SPGT 110408	4015-M4x11	
ATSM90-SP..06-D80X7-W32-L120-Z10	●	10	5	80	7	32	120	32	30	SPMG 060204 TGTC UCUNA UYGUNDUR. FOR TGTC INSERT. Под пластину TGTC	3007-M2.2x5	80-T07

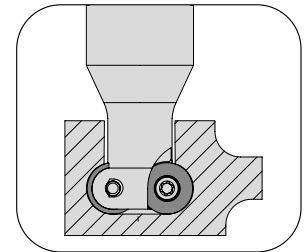
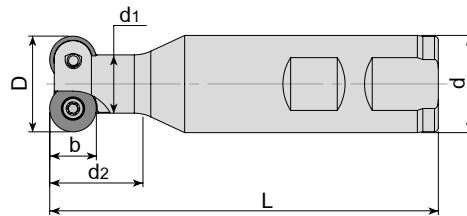

Takım Kodu
Ordering Code
Код для заказа

Stok Stock Наличие	Z	Takım Ölçüleri (mm) Dimension (mm) Размеры (мм)						Kesici Uç Insert Пластина	Yedek Parçaları / Spare Parts / Запасные части		
		D	b	d	L	d ₁	d ₂		Sıkma Vidası Screw Зажимной винт	Tork Anahtar Torx Key Торх Ключ	
ATSMR-RD0702-D17-W16-L90-Z02	●	2	17	7	16	90	10	12	RD.. 0702	3008-M2.5x6	80-T08
ATSMR-RD0702-D25-W16-L90-Z03	●	3	25	7	16	90	15	12			
ATSMR-RD0702-D35-W25-L100-Z05	●	5	35	7	25	100	20	20			
ATSMR-RD1003-D21-W25-L100-Z02	●	2	21	10	25	100	12	20	RD.. 1003	4015-M3.5x9	80-T15
ATSMR-RD1003-D80-W32-L165-Z06-H	●	6	80	10	32	165	30	31.5			
ATSMR-RD12T3-D25-W25-L100-Z02	●	2	25	12	25	100	15	24	RD.. 12T3	4015-M4.5x11	
ATSMR-RD12T3-D80-W32-L165-Z06-H	●	6	80	12	32	165	30	31.5			
ATSMR-RD1604-D34-W32-L110-Z02	●	2	34	16	32	110	20	30	RD.. 1604		

R: Sağ / Right / Правый L: Sol/Left/Левый
● Stokta / In Stock / В наличии ○ Stokta Yok / Non Stock Item / Нет в наличии
ISO Ucuna Uygunudur. / Compatiple with ISO Insert. / Под пластину ISO

Sipariş Örneği/Ordering Example/Образец заказа
1 ad./pcs./шт ATSM90-SP..05-D22.5X5-W25-L100-Z04
Kesme Hesabı : S 321 / Cutting Calculation : P 321 / Расчет режимов резания: стр. 321

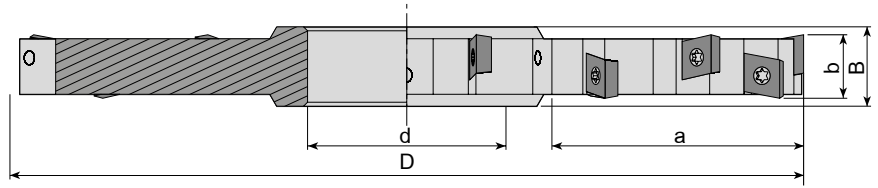

Takım Kodu
Ordering Code
Код для заказа

Stok
Stock
Наличие

Z

Toplam
Total
Общее

Etkili
Effective
Эффективное

D

b

a

d

B

Takım Ölçüleri (mm)
Dimension (mm)
Размеры (мм)

Kesici Uç
Insert
Пластина

Yedek Parçaları / Spare Parts / Запасные части

Sıkma Vidası
Screw
Зажимной винт

Tork Anahtar
Torx Key
Torx Ключ

ASDM-SPGT05-D80x6-d27-Z10	●	10	5	80	6	17	27	10	SPGT 050204 ZCC UCUNA UYGUNDUR. FOR ZCC INSERT. Под пластину ZCC	3006-M2x4	80-T06
ASDM-SPGT05-D100x6-d32-Z12	●	12	6	100	6	25	32	10			
ASDM-SPGT05-D125x6-d40-Z14	●	14	7	125	6	35	40	10			
ASDM-SPGT05-D160x6-d40-Z18	●	18	9	160	6	52	40	10			
ASDM-SPGT06-D80x7-d27-Z10	●	10	5	80	7	17	27	11	SPGT 060204 ZCC UCUNA UYGUNDUR. FOR ZCC INSERT. Под пластину ZCC	3007-M2.2x5	80-T07
ASDM-SPGT06-D100x7-d32-Z12	●	12	6	100	7	25	32	11			
ASDM-SPGT06-D125x7-d40-Z14	●	14	7	125	7	35	40	11			
ASDM-SPGT06-D160x7-d40-Z16	●	16	8	160	7	52	40	11			
ASDM-SPGT06-D200x7-d40-Z18	●	18	9	200	7	70	40	11			

R: Sağ / Right / Правый L: Sol/Left/Левый

● Stokta / In Stock / В наличии ○ Stokta Yok / Non Stock Item / Нет в наличии

Sipariş Örneği/Ordering Example/Образец заказа

1 ad./pcs./шт ASDM-SPGT05-D80x6-d27-Z10

Kesme Hesabı : S 321 / Cutting Calculation : P 321 / Расчет режимов резания: стр. 321



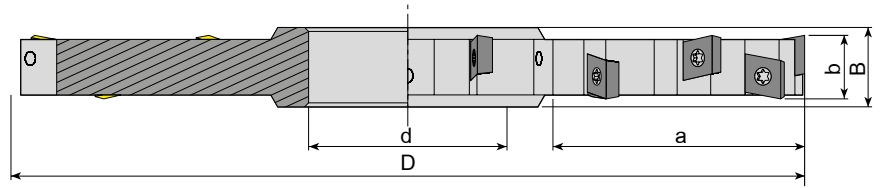

Takım Kodu
Ordering Code
Код для заказа

Takım Kodu Ordering Code Код для заказа	Stok Stock Наличие	Takım Ölçüleri (mm) Dimension (mm) Размеры (мм)						Kesici Uç Insert Пластина	Yedek Parçaları / Spare Parts / Запасные части		
		Z		D	b	a	d		B	Sıkma Vidası Screw Зажимной винт	Tork Anahtar Torx Key Торх Ключ
		Toplam Total Общие	Etkili Effective Эффективные								
ASDM-CC06-D80x8-d27-Z10	●	10	5	80	8	17	27	12	CC.. 0602.. ISO UCUNA UYGUNDUR. FOR ISO INSERT. Под пластину ISO	3008-M2.5x6	80-T08
ASDM-CC06-D100x8-d32-Z12	●	12	6	100	8	25	32	12			
ASDM-CC06-D125x8-d40-Z14	●	14	7	125	8	35	40	12			
ASDM-CC06-D160x8-d40-Z16	●	16	8	160	8	52	40	12			
ASDM-CC06-D200x8-d40-Z18	●	18	9	200	8	70	40	12			
ASDM-CC06-D80x10-d27-Z10	●	10	5	80	10	17	27	14			
ASDM-CC06-D100x10-d32-Z12	●	12	6	100	10	25	32	14			
ASDM-CC06-D125x10-d40-Z14	●	14	7	125	10	35	40	14			
ASDM-CC06-D160x10-d40-Z16	●	16	8	160	10	52	40	14			
ASDM-CC06-D200x10-d40-Z18	●	18	9	200	10	70	40	14			
ASDM-CC09-D80x12-d27-Z08	●	8	4	80	12	17	27	16	CC.. 09T3.. ISO UCUNA UYGUNDUR. FOR ISO INSERT. Под пластину ISO	4015-M3.5x11	80-T15
ASDM-CC09-D100x12-d32-Z10	●	10	5	100	12	25	32	16			
ASDM-CC09-D125x12-d40-Z12	●	12	6	125	12	35	40	16			
ASDM-CC09-D160x12-d40-Z14	●	14	7	160	12	52	40	16			
ASDM-CC09-D200x12-d40-Z16	●	16	8	200	12	70	40	16			
ASDM-CC09-D80x14-d27-Z08	●	8	4	80	14	17	27	18			
ASDM-CC09-D100x14-d32-Z10	●	10	5	100	14	25	32	18			
ASDM-CC09-D125x14-d40-Z12	●	12	6	125	14	35	40	18			
ASDM-CC09-D160x14-d40-Z14	●	14	7	160	14	52	40	18			
ASDM-CC09-D200x14-d40-Z16	●	16	8	200	14	70	40	18			
ASDM-CC12-D80x16-d27-Z06	●	6	3	80	16	17	27	20	CC.. 1204.. ISO UCUNA UYGUNDUR. FOR ISO INSERT. Под пластину ISO	1020-M5x11	80-T20
ASDM-CC12-D100x16-d32-Z08	●	8	4	100	16	25	32	20			
ASDM-CC12-D125x16-d40-Z10	●	10	5	125	16	35	40	20			
ASDM-CC12-D160x16-d40-Z12	●	12	6	160	16	52	40	20			
ASDM-CC12-D200x16-d40-Z14	●	14	7	200	16	70	40	20			
ASDM-CC12-D80x18-d27-Z06	●	6	3	80	18	17	27	22			
ASDM-CC12-D100x18-d32-Z08	●	8	4	100	18	25	32	22			
ASDM-CC12-D125x18-d40-Z10	●	10	5	125	18	35	40	22			
ASDM-CC12-D160x18-d40-Z12	●	12	6	160	18	52	40	22			
ASDM-CC12-D200x18-d40-Z14	●	14	7	200	18	70	40	22			
ASDM-CC12-D250x18-d40-Z16	●	16	8	250	18	90	40	22			
ASDM-CC12-D80x20-d27-Z06	●	6	3	80	20	17	27	24			
ASDM-CC12-D100x20-d32-Z08	●	8	4	100	20	25	32	24			
ASDM-CC12-D125x20-d40-Z10	●	10	5	125	20	35	40	24			
ASDM-CC12-D160x20-d40-Z12	●	12	6	160	20	52	40	24			
ASDM-CC12-D200x20-d40-Z14	●	14	7	200	20	70	40	24			
ASDM-CC12-D250x20-d40-Z16	●	16	8	250	20	90	40	24			

R: Sağ / Right / Правый L: Sol/Left/Левый

● Stokta / In Stock / В наличии ○ Stokta Yok / Non Stock Item / Нет в наличии

Sipariş Örneği/Ordering Example/Образец заказа

1 ad./pcs./шт ASDM-CC06-D80x8-d27-Z10

Kesme Hesabı : S 321 / Cutting Calculation : P 321 / Расчет режимов резания: стр. 321

A TİP / A TYPE / A Тип

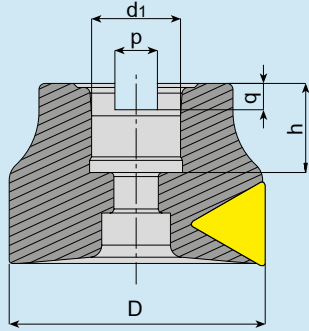

D	d1	d2	p	q	h
40	16	-	8.4	5.6	20
50	22	-	10.4	6.3	22
63	22	-	10.4	6.3	22
80	27	-	12.4	7	25
100	32	-	14.4	8	26

B TİP / B TYPE / B Тип

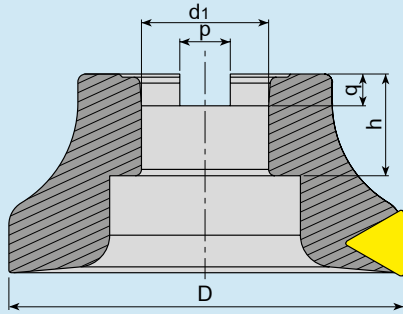

D	d1	d2	p	q	h
125	40	-	16.4	9	32

C TİP / C TYPE / C Тип

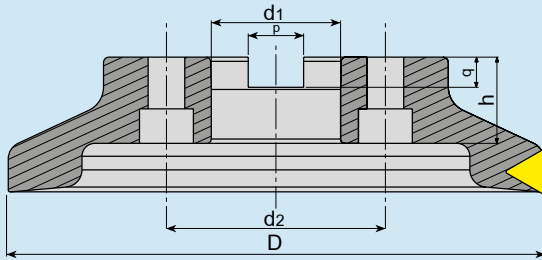

D	d1	d2	p	q	h
160	40	66.7	16.4	9	32
200	60	101.6	25.7	14	40
250	60	101.6	25.7	14	40

D TİP / D TYPE / D Тип

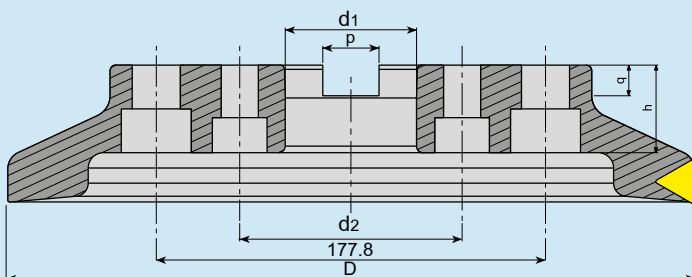

D	d1	d2	p	q	h
315	60	101.6	25.7	14	40

TAKMA UÇLU MATKAP (U-DRILL) KULLANMA KILAVUZU

Matkabınızı CNC torna tezgahına bağlamadan önce taretin merkezden kaçık olup olmadığını kontrol etmeniz gerekir. Şayet taretinizde kaçıklık varsa, takma uçlu matkabınızı kesinlikle kullanmayınız. Taretin düzeltilmesi için yapılması gereken işlemler ;

1. Taretin tutucusuna kullanacağınız takma uçlu matkabın çapında ve boyunda üzeri hassas olan silindirik bir parça bağlanır ve tezgahın X değeri sıfıra getirilir.
2. Tezgahın aynasına mıknatıslı komprotör saati yerleştirilir. Saatin uç kısmı tarete bağlanmış olduğumuz parçanın üstüne temas ettirilir.
3. Aynanın üzerine bağlanmış olduğumuz mıknatıslı komprotör ayna ile beraber 360 derece döndürülerek saatteki değişim oranına göre taretin sıfırlanması sağlanır.

TAKMA UÇLU MATKABINIZI CNC TORNANIZDA DAHA VERİMLİ KULLANMANIZ İÇİN GEREKLİ OLAN KESME HIZLARI ve DEVİRLERİ :

Grup No.	Malzemenin Cinsi	Malzemenin Öz.	Kesme Hızı Vc (m/dk)
1	Çok Yumuşak İş Çelikleri	C1010, Otomat vb.	220
2	İmalat Çelik ve Döküm Malz.	C1030 - 106 vb.	200
3	Takım ve İmalat Çeşitleri	CK-45, 4140, 7131 vb.	170
4	Sıcak İş ve Paslanmaz Çelikler	İmpaks vb.	150

Devir hesabı yapabilmek için önce malzemeyi seçiniz. Seçtiğiniz malzemenin kesme hızını (Vc) 1000 ile çarpıp 3.14'e bölmeliyiz. Çıkan değeri matkap çapına bölmeliyiz. **ÖRNEK** : Malzememiz takım ve imalat çeliği (3. grup), matkap çapı 25 mm kesme hızı 170 ise $170 \times 1000 = 170000 / 3.14 = 54140$, $54140 / 25 = 2166$ devir çıkar (Tezgahın İş Mili Devri). Tezgahın ilerlemesi kullanacağınız uç ile de alakalı olup 0.05 ile 0.10 arasında değişim gösterir. Kullanıcı kesici ucun kesişine göre bunu ayarlar.

İŞLEME MERKEZLERİ İÇİN İLERLEME HESABI :

Yukarıdaki hesaplamalarla bulmuş olduğunuz 2166 iş mili devrini, kesici uç ilerlemesi (mm/devir) 0.05 ile 0.10 arasındaki ilerleme seçenekleri ile çarpılır. **ÖRNEK 1** : $2166 \times 0.05 = 108$ **ÖRNEK 2** : $2166 \times 0.10 = 217$ çıkan sonuçlar 108 ve 217 işleme merkezleri için ilerleme mm/dakika hesabıdır.

Not: D4 ve üzeri takma uçlu matkaplarda tezgahın içten su verme basıncının en az 6 bar olması gerekmektedir.

USER'S GUIDE FOR AKKO U-DRILLS

Before connecting your U-Drill to CNC lathe, you have to check if the turret is eccentric from the center or not. If there is any eccentricity in your turret, never use your U-Drill;

Processes that should be done to fix the turret :

1. A cylindrical part whose surface is precision and whose length and diameter is the same with the U-Drill that you will use, should be mounted to the holder of turret and X value of the lathe should be brought to zero (0).
2. Comparator should be mounted to chuck. The end of the comparator should be contacted (touched) to the surface of the part that we mounted on the turret.
3. The comparator that we mounted on the chuck should be turned 360-degree with the chuck and turret should be zeroed by that turning according to changing rate of comparator.

CUTTING SPEED AND REVOLUTION THAT ARE NEEDED FOR USING (RUNNING) YOUR U-DRILLS MORE PRODUCTIVELY

Grup No.	Material	Material Type	Cutting Speed Vc (m/m)
1	Non-alloy steel and free cutting steel	C1010. Automat etc.	220
2	Low alloy steel and cast steel	C1030 - 106 etc.	200
3	Alloy steel and tool steel	CK-45, 4140, 7131 etc.	170
4	Hot Work Steel and Stainless Steel	Impax etc.	150

P.S. : The cutting speed may be concerned with the type of the insert that you use.

Fistly, choose the material to make calculation of revolution. You should multiply the cutting speed (Vc) of the material that you chose by 1000 and divide by 3.14. You should divide the value that you found by the diameter of U-Drill. For Example : If our material is alloy steel and tool steel (3rd group), diameter of the U-Drill is 25 mm, cutting speed is 170, we should calculate as following; $170 \times 1000 = 170000 / 3.14 = 54140$, $54140 / 25 = 2166$ rpm is the result that we found (Spindle Speed) Feed rate of the lathe is concerned with the U-Drill that you will use and changes between 0.05 and 0.10. The user sets it according to cut of cutting insert.

FEED CALCULATION FOR CENTRAL MACHINE :

2166 spindle speed, that we found as a result of above mentioned calculation, should be multiplied by cutting insert feed (mm/r) between 0.05 and 0.10 feed choisses. Example 1 : $2166 \times 0.05 = 108$

Example 2 : $2166 \times 0.10 = 217$ The results 108 and 217 are the feed mm/m calculation for central machine.

Note: Cooling water pressure of lathe must be minimum 6 bar for our D4 u-drills and u-drills longer than D4.

РУКОВОДСТВО ДЛЯ ЭКСПЛУАТАЦИИ СВЕРЕЛ АККО

Перед установкой сверла в станок с ЧПУ, вы должны проверить расположена ли револьверная головка эксцентрично относительно центра или нет. Если в вашей головке есть какой-то эксцентриситет, никогда не используйте сверло. Процессы, которые необходимо выполнить, чтобы зафиксировать головку:

1. Цилиндрическая часть, поверхность которой точна, и длина и диаметр которой совпадают с используемым сверлом, должны быть установлены в оправке револьверной головки, а значение X токарного станка должно быть доведено до нуля (0).
2. Компаратор должен быть установлен на патрон. Конец компаратора должен соприкоснуться с поверхностью детали, которую мы установили в револьверной головке.
3. Компаратор, который мы установили на патрон, должен быть повернут на 360 градусов, а патрон и головка должны быть обнулены этим поворотом в соответствии с изменением скорости компаратора.

РЕКОМЕНДУЕМЫЕ РЕЖИМЫ РЕЗАНИЯ СВЕРЕЛ

№	Материал	Марка	Скорость резания Vc (м/мин)
1	Нелегированная сталь и быстрорежущая сталь	C1010. Automat и т.д.	220
2	Низколегированная сталь и литая сталь	C1030 - 106 vb.	200
3	Инструментальная и легированная стал	CK-45, 4140, 7131 vb.	170
4	Закаленная и нержавеющая сталь	Imрах и т.д.	150

P.S.: Скорость резания может зависеть от типа используемой пластины. Во-первых, выберите материал для расчета режима резания. Вы должны умножить скорость резания (Vc) выбранного материала на 1000, и разделить на 3,14. Вы должны разделить значение, которое вы нашли на диаметр сверла.

Пример: если наш материал представляет собой легированную сталь и инструментальную сталь (3-я группа), диаметр сверла составляет 25 мм, скорость резания - 170, мы должны рассчитать следующее: $170 \times 1000 / 3.14 = 54140$, $54140 / 25 = 2166$ об / мин - результат, который мы получили скорость вращения шпинделя. Скорость подачи токарного станка зависи от сверла, которое вы будете использовать,

РАСЧЕТ ПОДАЧИ:

2166 скорость вращения шпинделя, которую мы нашли ранее, необходимо умножить на подачу (мм/об) в зависимости от сплава пластины от 0.05 до 0.10. Пример 1: $2166 \times 0.05 = 108$. Пример 2: $2166 \times 0.10 = 217$. Результаты 108 и 217 представляют собой исходный расчет мм/мин для центральной машины. Примечание: Давление охлаждающей жидкости токарного станка должна быть не менее 6 Бар для сверла D4 и длинее.

SIKMA TORKU TAVSİYELERİ - RECOMMENDED TIGHTENING TORQUE

Рекомендуемый момент затяжки

- Takımı Sıkmadan Önce Aşağıdaki Bilgileri Okuyunuz.
Read below information before tightening the tool.
Прочтите нижеследующую информацию, прежде чем затягивать инструмент.
- Vidalı Takımın Vida Ölçüsü ile Tutucunun İç Vida Ölçüsünü Sıkmadan Önce Kontrol Ediniz.
Check screw set's the screw size and together with mounting arbor inner dimension of screws.
Проверьте совпадают ли размеры резьбы фрезерной головки и оправки
- Takımı Tutucuya Sıkarken Tablodaki İlgili Değerlere Göre İşlem Yapınız.
When tightening head to an arbor, follow the related tightening torque in the table.
При затягивании фрезерной головки в оправке, следуйте значениям крутящего момента в таблице ниже

Vida Screw Резьба	Tork Torque (N.m) Крутящий момент (Н·м)
M6	8
M8	23
M10	46
M12	80
M16	90



FREZELEME İŞLEMİNDE DEVİR ve İLERLEME HESABI

Vc.	S	D	F	Z	fz	FORMÜLLER
Kesme Hızı (Uç Kutusunun Arkasından Okuyunuz)	İş Mili Devir Sayısı	Tarama Kafası Çapı	İlerleme	Tarama Kafası Ağız Sayısı	Diş Başına Düşen İlerleme Miktarı (Uç Kutusunun Arkasından Okuyunuz)	Devir Hesabı : $S=(Vc \times 1000) / (3,14 \times D)$ İlerleme Hesabı : $F=S \times Z \times fz$

Örnek : D=50 mm çapında, Z=5 ağızlı tarama kafası ile frezeleme yapacağız. Kesici uç kutusunun arkasında kesme hızı Vc=200m/dk. olarak verilmiş olsun. Tezgaha girilecek devri hesaplayalım: **Vc=200 m/dk. D=50 mm** S = Öncelikle Kesme Hızı 1000 ile çarpılır, çıkan sonuç 3,14 sayısına bölünür, buradan çıkan sonuç da tarama kafası çapına bölünür.

$S=200 \times 1000 = 200000 \rightarrow 200000/3,14=63663 \rightarrow 63663/50=1273$ devir **S=1273 dev/dakika** devri bulduktan sonra ilerlemeyi bulalım: **Z=5** ağızlı tarama kafası olsun **fz=0,12** olarak uç kutusunun arkasından okunmuş olsun F= yukarıda bulmuş olduğumuz devir sayısı ile ağız sayısı çarpılır, çıkan sonuç diş başına düşen ilerleme miktarı ile çarpılır.

$F=1273 \times 5 = 6365 \rightarrow 6365 \times 0,12 = 763$ $F=763$ mm/dakika

Tezgaha girilecek olan devir = S 1273 Tezgaha girilecek olan ilerleme : **F 763 ortalama değerdir.**

Not: Vc ve fz değerlerinin uç kutusunun arkasında verilmiş olması gerekir. Eğer bu değerler uç kutusunun üzerinde yoksa, kesici ucun katalogundan bulunuz. İşleyeceğiniz malzeme çelik ise P, paslanmaz çelik ise M, dökme demir ise K bölümünde yazılı olan Vc ve fz değerlerini okuyun.

CALCULATING SPINDLE SPEED and FEED RATE FOR MILLING PROCESS

Vc.	S	D	F	Z	fz	FORMULAS
Cutting Speed (Please read from the back- side of cutting insert box)	Spindle Revolution rpm	Milling Tool Diameter	Feed Rate	Number of Effective Tooth	Feed Per Tooth (Please Read From The Back Side of Cutting Insert Box)	Calculation of Revolution : $S=(Vc \times 1000) / (3,14 \times D)$ Feed Rate Calculation : $F=S \times Z \times fz$

For Example : We will make milling with milling tool whose diameter is D 50 mm, whose teeth number is Z=5. The spindle revolution was written as Vc=200m/mn at the back side of cutting insert box. Let's calculate the revolution that should be entered to the milling machine : Vc=200 m/mn D=50 mm

S = Firstly Cutting Speed is multiplied with 1000, the result should be divided by 3.14 , the last result should be divided by diameter of milling tool.

$S = 200 \times 1000 = 200000 \rightarrow 200000/3,14 = 63663 \rightarrow 63663/50 = 1273$ rev $S=1273$ rev / mn

After finding spindle revolution, let's find feed rate : milling tool with Z=5 teeth and we read fz=0,12 from the back side of cutting insert box.

F = Tooth number should be multiplied with revolution, the result should be multiplied with feed per tooth.

$F = 1273 \times 5 = 6365 \rightarrow 6365 \times 0,12 = 763$ $F = 763$ mm / mn

Revolution that should be entered to the milling machine = S 1273 Feed Rate that should be entered to the milling machine = F 763 average value.

P.S : The values Vc and fz has to be written at the back side of the cutting insert. If these values were not written on the cutting insert box, please find them from cutting insert catalogue. If the material that you will work is steel, please read Vc and fz values that were written on the part P, if it is stainless steel please read from the part M, if it is cast iron please read from the part K.

РАСЧЕТ СКОРОСТИ ВРАЩЕНИЯ ШПИНДЕЛЯ И ПОДАЧИ ДЛЯ ФРЕЗЕРОВАНИЯ

Vc.	S	D	F	Z	fz	FORMÜLLER
Скорость резания (Пожалуйста прочитайте на обратной стороне упаковки пластины)	Частота вращения шпинделя (мм/об*мин)	Диаметр фрезы	Скорость подачи	Число эффективных зубьев	Подача на зуб (Пожалуйста прочитайте на обратной стороне упаковки пластины)	Расчет частоты вращения шпинделя: $S=(Vc \times 1000) / (3,14 \times D)$ Расчет скорости подачи: $F=S \times Z \times fz$

Например: Мы будем фрезеровать фрезой диаметром D 50 мм. С числом зубьев Z=5. На упаковке мы нашли скорость резания Vc=200 м/мин. Чтобы рассчитать частоту вращения шпинделя фрезерного станка, необходимо подставить такие значения: Vc=200 м/мин D=50 мм, тогда S = Скорость резания умножаем на 1000, результат необходимо разделить на 3,14, и затем разделить на диаметр фрезы.

$S = 200 \times 1000 = 200000 \rightarrow 200000/3,14 = 63663 \rightarrow 63663/50 = 1273$ об $S=1273$ об/мин. После того, как мы нашли частоту вращения шпинделя, необходимо найти скорость подачи: Фреза с числом зубьев Z=5 и значением на упаковке пластины fz=0,12.

P.S.: Значения Vc и fz должны быть указаны на упаковке пластины. Если эти значения не указаны, пожалуйста, найдите эту пластину в каталоге производителя пластин. Если обрабатываемый материал сталь, найдите значения Vc и fz в группе применения P, если это нержавеющая сталь найдите в группе M, если это чугун - в группе применения K.

Gövde Malzemesine Göre Delik İçi Kater Uygulama Kılavuzu

Internal Boring Bars Application Guide, Related to Body Material

Рекомендации по выбору материала хвостовика резца в зависимости от вылета

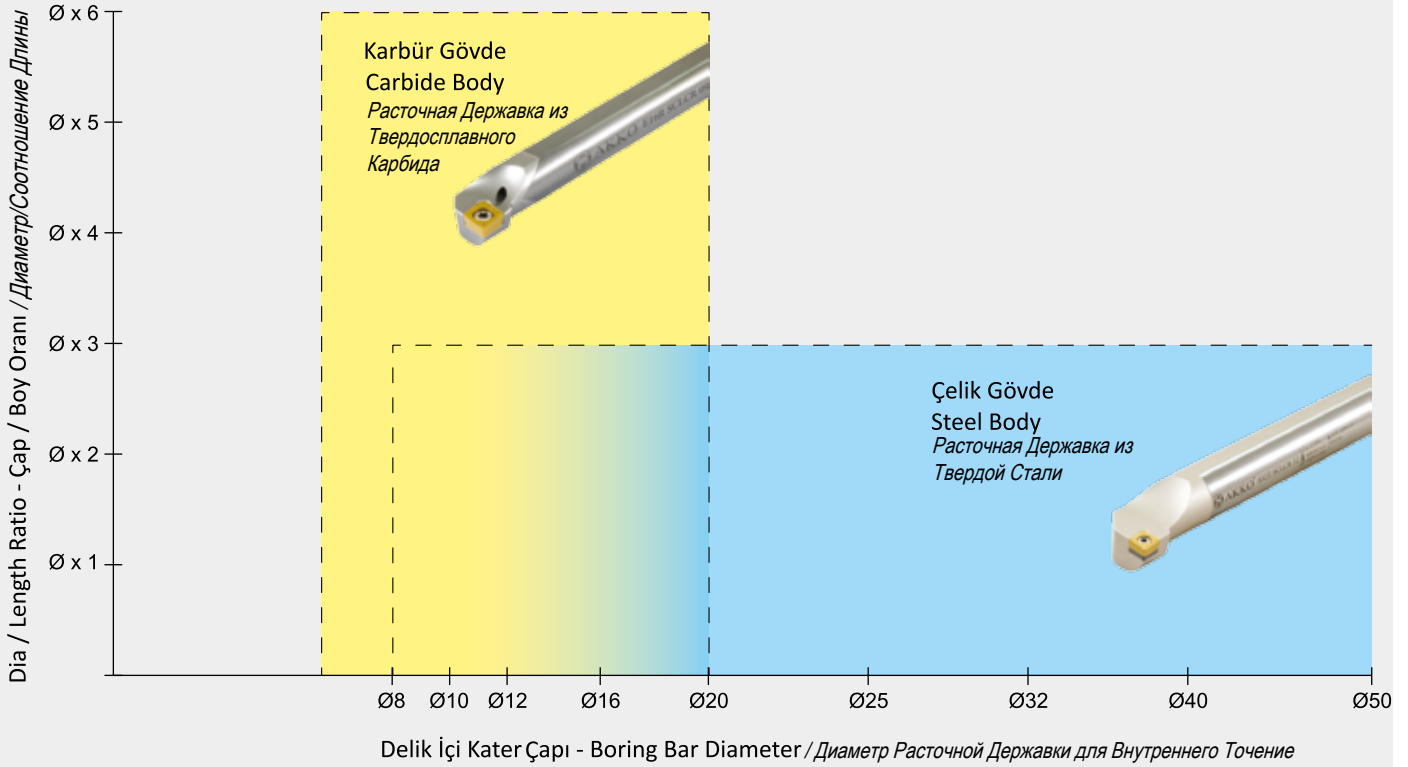

T Kanal Freze Kullanım ve Ön Hazırlama Kılavuzu

Application Guide For T-Slot Milling

Предварительная подготовка заготовки для прорезания Т-образных пазов

T kanal frezelemede talaşın rahat boşaltılması için iş parçası resimde gösterildiği şekilde işlenmelidir.

Örnek: ATSM90-CC06- D32X10-W25- L100-Z04 kodlu T freze ile kanal açmadan önce, takımın boğazının çalışacağı kısmın parmak freze ile işlenmesi gerekir. Bu durumda kanalın tamamen işlenmesi çok yanlıştır. Tabanda ($0.8 \times b = 0.8 \times 10$) 8mm işlenmeden bırakılmalıdır. Bu bölgeyi T frezenin işlemesi, takımın daha sağlıklı çalışması açısından gereklidir.

İşlenen kanallarda yumuşak kesim için talaşlar uzaklaştırılmış olmalıdır.

When T slot machining steel, the workpiece must be machined as shown in the drawing to ensure smooth chip evacuation.

Example: Before slotting with the T - slot milling cutter - code ATSM90-CC06-D32X10-W25-L100-Z04,

The area of the neck of the tools to be worked and must be machined by End-Mill.

In this case, it is very wrong to machining the slot completely.

Bottom area ($0.8 \times b = 0.8 \times 10$) should be left 8 mm without machining.

This area's operation must be machined by the T- slot milling cutter which is also necessary for the healthier work of the tool holder.

Slots to be machined must be free from chips for smooth machining.

При обработке Т-образных пазов необходимо прорезать предварительную канавку согласно эскиза.

Пример: ATSM90-CC06-d32x10-W25-L100-z04 - грибковая фреза $\varnothing 32$ мм и шириной 10 мм.

Первоначально фрезеруют прямоугольный паз шириной равной или меньшей узкой части "Т-паза" и глубиной равной полной глубине, либо с гарантированным перекрытием поднутрения. Максимальный припуск на грибковую фрезу не должен превышать 80% от ширины b. Для вышеуказанной фрезы допустимый припуск 8 мм.

После предварительной прорезки паза необходимо удалить стружку до начала работы грибковой фрезы.

KULLANIM İÇİN UYARI
CAUTION FOR USE
ВАЖНО ДЛЯ ИСПОЛЬЗОВАНИЯ

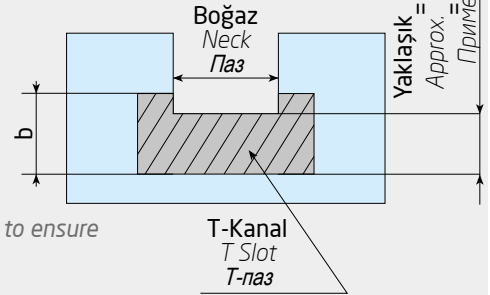

α = 5 Kat Dayanıklılık**α = 5 Times Long Life****α = В 5 раз больше устойчивости****Alfa Kaplamanın Avantajları***Alpha Coating Advantages***Преимущество Альфа покрытия**

- **Yüksek aşınma direnci**
High resistance to abrasion
Высокая стойкость к износу
- **Yüksek yüzey sertliği**
750-800 Vickers
High surface hardness
750-800 Vickers
Высокая твердость поверхности 750-800 Vickers
- **Temperlemeye karşı yüksek direnç**
High resistance to tempering
Высокая устойчивость температуры отпуска
- **Yüksek yorulma mukavemeti**
High fatigue strength
Высокая прочность от усталости
- **Yüksek çizik ve çentik direnci**
High scratch and impact resistance
Высокая устойчивость от царапин и вырезов
- **Paslanmaz olmayan çelikler için daha yüksek korozyon direnci**
Resistant to corrosion of non-stainless steel
Устойчивость от коррозии из нержавеющей стали

takımınız neden
daha uzun ömürlü
olmasın?...

longer tool life...**Более длительный срок лужбы инструмента****α Çevre Dostudur. α is friend of environment.**
α Является другом окружающей среды**İnsan sağlığı açısından zararlı değildir. Is not harmful to human health.**
Не вреден для здоровья человека**Gaz ve diğer atıkları çevreyi kirletmez. Gas and other wastes will not pollute the environment.**
Не загрязняет окружающую среду

ALTLIKLAR / SHIMS / ОПОРНЫЕ ПЛАСТИНЫ

ÜRÜN RESMİ/PICTURE ИЗОБРАЖЕНИЕ	ÜRÜN KODU/CODE КОД	ÜRÜN DETAYI / PRODUCT DETAIL ОПИСАНИЕ	
	AATN-2-0001	S-SİSTEM için / For S-SYSTEM / S-ТИП T-M SİSTEM için / For T-M SYSTEM / T-M ТИП	
	AATN-2-0002	C-SİSTEM için / For C-SYSTEM / C-ТИП	
	AATN-3-0025	P-SİSTEM için / For P-SYSTEM / P-ТИП	
	AATN-3-0015	T-M-P SİSTEM için / For T-M SYSTEM / T-M-P ТИП	
	AATN-2-0020	DİŞ VİDA 16 ALTLIK / For THREADING 16 SHIM / РЕЗЬБОВАЯ ОПОРНАЯ ПЛАСТИНА 16	
	AATN-2-0004	DİŞ VİDA 22 ALTLIK / For THREADING 22 SHIM / РЕЗЬБОВАЯ ОПОРНАЯ ПЛАСТИНА 22	
	ATS-16E	DİŞ VİDA 16, DİŞ ÇAP SAĞ - DELİK İÇİ SOL ALTLIK / For THREADING SYSTEM 16 SHIM, EXTERNAL RIGHT-INTERNAL LEFT / РЕЗЬБОВАЯ ОПОРНАЯ ПЛАСТИНА 16, НАРУЖНАЯ ПРАВЯЯ - ВНУТРЕННЯЯ ЛЕВАЯ	
	ATS-16I	DİŞ VİDA 16, DİŞ ÇAP SOL - DELİK İÇİ SAĞ ALTLIK / For THREADING SYSTEM 16 SHIM, EXTERNAL LEFT-INTERNAL RIGHT / РЕЗЬБОВАЯ ОПОРНАЯ ПЛАСТИНА 16, НАРУЖНАЯ ЛЕВАЯ - ВНУТРЕННЯЯ ПРАВЯЯ	
	ATS-22E	DİŞ VİDA 22, DİŞ ÇAP SAĞ - DELİK İÇİ SOL ALTLIK / For THREADING SYSTEM 22 SHIM, EXTERNAL RIGHT-INTERNAL LEFT / РЕЗЬБОВАЯ ОПОРНАЯ ПЛАСТИНА 22, НАРУЖНАЯ ПРАВЯЯ - ВНУТРЕННЯЯ ЛЕВАЯ	
	ATS-22I	DİŞ VİDA 22, DİŞ ÇAP SOL - DELİK İÇİ SAĞ ALTLIK / For THREADING SYSTEM 22 SHIM, EXTERNAL LEFT-INTERNAL RIGHT / РЕЗЬБОВАЯ ОПОРНАЯ ПЛАСТИНА 22, НАРУЖНАЯ ЛЕВАЯ - ВНУТРЕННЯЯ ПРАВЯЯ	
	ATS-27E	DİŞ VİDA 27, DİŞ ÇAP SAĞ - DELİK İÇİ SOL ALTLIK / For THREADING SYSTEM 27 SHIM, EXTERNAL RIGHT-INTERNAL LEFT / РЕЗЬБОВАЯ ОПОРНАЯ ПЛАСТИНА 27, НАРУЖНАЯ ПРАВЯЯ - ВНУТРЕННЯЯ ЛЕВАЯ	
	ATS-27I	DİŞ VİDA 27, DİŞ ÇAP SOL - DELİK İÇİ SAĞ ALTLIK / For THREADING SYSTEM 27 SHIM, EXTERNAL LEFT-INTERNAL RIGHT / РЕЗЬБОВАЯ ОПОРНАЯ ПЛАСТИНА 27, НАРУЖНАЯ ЛЕВАЯ - ВНУТРЕННЯЯ ПРАВЯЯ	
	AACN-2-0001	S-SİSTEM için / For S-SYSTEM / S-ТИП T-SİSTEM için / For T-SYSTEM / T-ТИП	
	AACN-2-0002	P-SİSTEM için / For P-SYSTEM / P-ТИП	
	AACN-2-0003	S-SİSTEM için / For S-SYSTEM / S-ТИП	
	AACN-3-0001	T-M-P SİSTEM için / For T-M-P SYSTEM / T-M-P ТИП C-SİSTEM için / For C-SYSTEM / C-ТИП	
	AACN-3-0002	T-P SİSTEM için / For T-P SYSTEM / T-P ТИП	
	AACN-3-0003	T-P SİSTEM için / For T-P SYSTEM / T-P ТИП	
	AACN-3-0008	T-P SİSTEM için / For T-P SYSTEM / T-P ТИП	
	AAWN-2-0003	T-M-P SİSTEM için / For T-M-P SYSTEM / T-M-P ТИП	
	AAWN-3-0001	T-M-P SİSTEM için / For T-M-P SYSTEM / T-M-P ТИП	
	AAWN-SW317	T-M-P SİSTEM için / For T-M-P SYSTEM / T-M-P ТИП	
	AKS-16L	C-SİSTEM için / For C-SYSTEM / C-ТИП	
	AKS-16R	C-SİSTEM için / For C-SYSTEM / C-ТИП	
	AASD-3-0001	S-SİSTEM FREZELEME için / For S-SYSTEM MILLING / S-ТИП ПРИЖИМ ДЛЯ ФРЕЗ ПОД	
	AASE-3-0001	S-SİSTEM FREZELEME için / For S-SYSTEM MILLING / S-ТИП ПРИЖИМ ДЛЯ ФРЕЗ ПОД	
	AASN-2-0001	S-SİSTEM için / For S-SYSTEM / S-ТИП	
	AASN-2-0002	P-SİSTEM için / For P-SYSTEM / P-ТИП	
	AASN-2-0004	S-SİSTEM için / For S-SYSTEM / S-ТИП	
	AASN-3-0004	T-P SİSTEM için / For T-P SYSTEM / T-P ТИП C-SİSTEM için / For C-SYSTEM / C-ТИП	
	AASN-3-0023	T-P SİSTEM için / For T-P SYSTEM / T-P ТИП	
	AASN-3-0005	T-P SİSTEM için / For T-P SYSTEM / T-P ТИП	
	AASN-3-0020	T-P SİSTEM için / For T-P SYSTEM / T-P ТИП	
	AASN-20020	PSDNN KARTUŞ için / For PSDNN CARTRIDGE / ДЛЯ КАРТРИДЖЕЙ	
		AADN-2-0001	S-SİSTEM için / For S-SYSTEM / S-ТИП T-SİSTEM için / For T-SYSTEM / T-ТИП
		AADN-SD317	P-SİSTEM için / For P-SYSTEM / P-ТИП
		AADN-3-0001	T-M-P SİSTEM için / For T-M-P SYSTEM / T-M-P ТИП C-SİSTEM için / For C-SYSTEM / C-ТИП
		AADN-2-0003	T-SİSTEM için / For T-SYSTEM / T-ТИП
		AAVN-2-0002	S-SİSTEM için / For S-SYSTEM / S-ТИП T-SİSTEM için / For T-SYSTEM / T-ТИП
		AARC-3-0001	C-SİSTEM için / For C-SYSTEM / C-ТИП
	AARC-3-0002	C-SİSTEM için / For C-SYSTEM / C-ТИП	
	AARC-3-0003	C-SİSTEM için / For C-SYSTEM / C-ТИП	

BASKI PABUÇLARI / CLAMPS / ПРИЖИМ

ÜRÜN RESMİ/PICTURE ИЗОБРАЖЕНИЕ	ÜRÜN KODU/CODE КОД	ÜRÜN DETAYI / PRODUCT DETAIL ОПИСАНИЕ
	ATK-01	T-SİSTEM için / For T-SYSTEM / T-ТИП DNMG 11, WNMG 06, TNMG 16, CNMG 09 BASKI PABUCU / CLAMP / ПРИЖИМ
	ATK-02	T-SİSTEM için / For T-SYSTEM / T-ТИП CNMG 12, WNMG 08, TNMG 22, DNMG 15, SNMG 12 BASKI PABUCU / CLAMP / ПРИЖИМ
	ATK-03	T-SİSTEM için / For T-SYSTEM / T-ТИП VNMG 16 BASKI PABUCU / CLAMP / ПРИЖИМ
	ATK-04	T-SİSTEM için / For T-SYSTEM / T-ТИП CNMG 16, SNMG 15 BASKI PABUCU / CLAMP / ПРИЖИМ
	AMK-01	M-SİSTEM için / For M-SYSTEM / M-ТИП WNMG 06 BASKI PABUCU / CLAMP / ПРИЖИМ
	AMK-02	M-SİSTEM için / For M-SYSTEM / M-ТИП DELİK İÇİ / INTERNAL Ø20 TNMG 16, Ø25 MT-NR/L 16 BASKI PABUCU / CLAMP M-ТИП ПРИЖИМ ДЛЯ РАСТОЧНЫХ ДЕРЖАВОК Ø20, Ø25 MT-NR/L 16 ПОД TNMG 16
	AMK-03	M-SİSTEM için / For M-SYSTEM / M-ТИП DNMG 11, CNMG 12 BASKI PABUCU / CLAMP / ПРИЖИМ
	AMK-04	M-SİSTEM için / For M-SYSTEM / M-ТИП DNMG 15, TNMG 16-22 BASKI PABUCU / CLAMP / ПРИЖИМ
	AMK-05	M-SİSTEM için / For M-SYSTEM / M-ТИП WNMG 08 BASKI PABUCU / CLAMP / ПРИЖИМ
	AMK-07	M-SİSTEM için / For M-SYSTEM / M-ТИП S20R MCLNR/L BASKI PABUCU / CLAMP / ПРИЖИМ
	ACK-01-R	C-SİSTEM için / For C-SYSTEM / C-ТИП KNUX-R BASKI PABUCU / CLAMP / ПРИЖИМ
	ACK-02-L	C-SİSTEM için / For C-SYSTEM / C-ТИП KNUX-L BASKI PABUCU / CLAMP / ПРИЖИМ
	ACK-03	C-SİSTEM için / For C-SYSTEM / C-ТИП 154.91 DIŞ ÇAP ve DELİK İÇİ/EXTERNAL and INTERNAL/Ø25-Ø32/ ДЛЯ НАРУЖНЫХ И ВНУТРЕННИХ ОБРАБОТОК / ПРИЖИМ BASKI PABUCU / CLAMP
	ACK-04	P-C SİSTEM için / For P-C SYSTEM / P-СТИП CTFPR KARTUŞ BASKI PABUCU / CARTRIDGE CLAMP / ПРИЖИМ ДЛЯ КАРТРИДЖЕЙ
	ACK-05	P-C SİSTEM için / For P-C SYSTEM / P-СТИП FREZELEME ve DIŞ VİDA AÇMA TAKIMLARINA GÖRE İLAVE BASKI PABUCU ADDITIONAL LITTLE CLAMP for MILLING and THREADING CLAMP / P-C-ТИП ДОПОЛНИТЕЛЬНЫЙ ПРИЖИМ ДЛЯ ФРЕЗ И РЕЗЬБОВЫХ ДЕРЖАВОК
	ACK-06	C-SİSTEM için / For C-SYSTEM / C-ТИП 154.91 DELİK İÇİ / INTERNAL Ø16-Ø20 BASKI PABUCU / CLAMP C-ТИП ПРИЖИМ ДЛЯ РАСТОЧНЫХ ДЕРЖАВОК Ø16-Ø20
	ACK-07	C-SİSTEM için / For C-SYSTEM / C-ТИП SERAMİK CNGN, SNGN, DNGN YEDEK TAKIMI SPARE PART SET of CERAMIC CNGN, SNGN, DNGN C-ТИП ЗАПАСНОЙ КОМПЛЕКТ ПОД КЕРАМИЧЕСКИЕ ПЛАСТИНЫ CNGN, SNGN, DNGN
	ACK-08	C-SİSTEM için / For C-SYSTEM / C-ТИП SERAMİK TNGN, YEDEK TAKIMI SPARE PART SET of CERAMIC TNGN C-ТИП ЗАПАСНОЙ КОМПЛЕКТ ПОД КЕРАМИЧЕСКУЮ ПЛАСТИНУ TNGN
	ACK-09	P-SİSTEM için / For P-SYSTEM / P-ТИП CNMG 16-19, SNMG 15-19 İLAVE BÜYÜK BASKI PABUCU ADDITIONAL BIG CLAMP / P-ТИП ДОПОЛНИТЕЛЬНЫЙ БОЛЬШОЙ ПРИЖИМ ПОД CNMG 16-19, SNMG 15-19
	ACK-10	C-SİSTEM FREZELEME için / For C-SYSTEM MILLING C-ТИП ПРИЖИМ ДЛЯ ФРЕЗ ПОД SPKN 12, Ø50-Ø63 TPKN 16 BASKI PABUCU / CLAMP / ПРИЖИМ (M8x8)
	ACK-11	C-SİSTEM FREZELEME için / For C-SYSTEM MILLING C-ТИП ПРИЖИМ ДЛЯ ФРЕЗ ПОД Ø80-Ø100 TPKN 16-TPKN 22, OFKR 07, HNMX 09 BASKI PABUCU / CLAMP / ПРИЖИМ (M8x10)
	ACK-12	C-SİSTEM için / For C-SYSTEM / C-ТИП CTSPR KARTUŞ BASKI PABUCU / CARTRIDGE CLAMP / ПРИЖИМ ДЛЯ КАРТРИДЖЕЙ
	ACK-15	S-SİSTEM FREZELEME için / For S-SYSTEM MILLING S-ТИП ПРИЖИМ ДЛЯ ФРЕЗ ПОД RD.. 10-12 BASKI PABUCU / CLAMP / ПРИЖИМ
	ACK-19	S-SİSTEM FREZELEME için / For S-SYSTEM MILLING S-ТИП ПРИЖИМ ДЛЯ ФРЕЗ ПОД WD0805D BASKI PABUCU / CLAMP / ПРИЖИМ
	ACK-23	C-SİSTEM için / For C-SYSTEM SERAMİK DNGN 11, YEDEK TAKIMI SPARE PART SET of CERAMIC DNGN 11 C-ТИП ЗАПАСНОЙ КОМПЛЕКТ ПОД КЕРАМИЧЕСКИЕ ПЛАСТИНЫ DNGN 11
	ACK-24	S-SİSTEM FREZELEME için / For S-SYSTEM MILLING S-ТИП ПРИЖИМ ДЛЯ ФРЕЗ ПОД XD0806D BASKI PABUCU / CLAMP / ПРИЖИМ
	ACK-26	C-SİSTEM için / For C-SYSTEM / C-ТИП XNMU 0806.. BASKI PABUCU / CLAMP / ПРИЖИМ
	ACK-27	C-SİSTEM için / For C-SYSTEM / C-ТИП RCGX 06 BASKI PABUCU / CLAMP / ПРИЖИМ
	ACK-28	C-SİSTEM için / For C-SYSTEM / C-ТИП RCGX 09 BASKI PABUCU / CLAMP / ПРИЖИМ
	ACK-29	C-SİSTEM için / For C-SYSTEM / C-ТИП RCGX 12 BASKI PABUCU / CLAMP / ПРИЖИМ

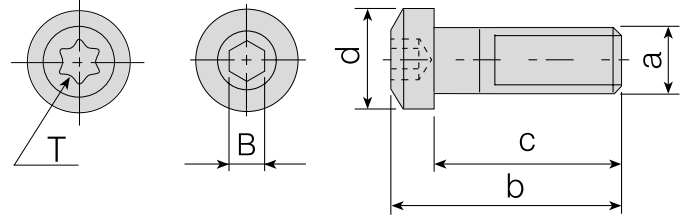

BASKI PABUÇ VİDALARI / CLAMP SCREWS / ВИНТЫ ДЛЯ ПРИЖИМОВ

Таким Kodu Ordering Code Код для заказа	a (M)	b	c	d	B(T)	Ürün Detayı / Product Detail / ОПИСАНИЕ
AKV-01-M5X22	M5x0.8	25.1	22	11	3	T-SİSTEM için / For T-SYSTEM / Т-ТИП DNMG 11, WNMG 06, TNMG 16
AKV-02-M6X22	M6x1.0	25.3	22	11	3	T-SİSTEM için / For T-SYSTEM / Т-ТИП CNMG 12, WNMG 08, TNMG 22, DNMG 15, SNMG 12, VNMG 16 M-SİSTEM için / For M-SYSTEM / М-ТИП TNMG 16, TNMG 22 KANAL KATERİ için / For EXTERNAL GROOVING 2mm Dış Çap Kanal Kater Vidası / External Grooving Tools Screw ДЛЯ КАНАВОЧНЫХ ДЕРЖАВОК 2мм Винт Резец для наружных канавочных резцов
AKV-03-M6X22	M6x1.0	25.3	22	10	3	M-SİSTEM için / For M-SYSTEM / М-ТИП WNMG 08
AKV-04-M5X17	M5x0.8	20	17	8.5	3	M-SİSTEM için / For M-SYSTEM / М-ТИП S20R MT-NR/L 16, S20R-S25S MWLN/R/L 06, S25S MDUNR/L 11-Dış Çap / External / наружных MWLN/R 06
AKV-05-M6X25	M6x1.0	29.5	25	13.8	4	T-SİSTEM için / For T-SYSTEM / Т-ТИП Eski Ürün Vidası / Old Products Screws / Винт устаревшей конструкции CNMG 16, SNMG 15
AKV-06-M6X20	M6x1.0	26.5	20	10.6	4	C-SİSTEM için / For C-SYSTEM / С-ТИП KNUX 16
AKV-07-M6X22	M6x1.0	23.5	22	8.5	3	C-SİSTEM için / For C-SYSTEM / С-ТИП ADKT-154.91, AIKT-154.91-R/L-32
AKV-10-M6X14	M6x1.0	16	14	8.8	4	C-SİSTEM için / For C-SYSTEM / С-ТИП AIKT-154.91-R/L-16, AIKT-154.91-R/L-20, AIKT-154.91-R/L-25
AKV-11-M8X29	M8x1.25	33.6	29	11	4	C-SİSTEM için / For C-SYSTEM / С-ТИП TNGN 16, CNGN 12, DNGN 15, SNGN 12
AKV-17-M5X15	M5x0.8	18	15	8.55	3	M-SİSTEM için / For M-SYSTEM / М-ТИП S16P MWLN/R/L 06
AKV-19-M7X25	M7x1.0	29.6	25	14	4	T-SİSTEM için / For T-SYSTEM / Т-ТИП Yeni / New / Новинка CNMG 16, SNMG 15
AKV-20-M6X19	M6x1.0	22	19	11	3	M-SİSTEM için / For M-SYSTEM / М-ТИП S25S MDUNR/L 15
AKV-21-M6X18	M6x1.0	20	18	8.5	3	C-SİSTEM için / For C-SYSTEM / С-ТИП AIKT-154.91-R/L-25
AKV-23-M4X10	M4x0.7	12.2	10	7.4	15	KARTUŞ için / For CARTRIDGE/ ДЛЯ КАРТРИДЖЕЙ MONTAJ VİDASI / MOUNTING SCREW / МОНТАЖНЫЙ ВИНТ
AKV-27-M6X20	M6x1.0	23.3	20	10	3	M-SİSTEM için / For M-SYSTEM / М-ТИП S25S MWLN/R/L 08

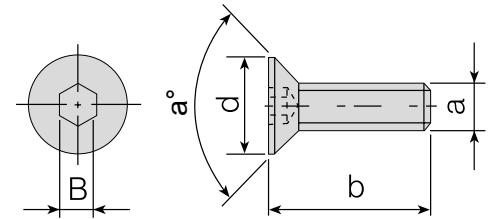

ALTLIK VİDALARI / SHIM SCREWS / ВИНТ ДЛЯ ОПОРНОЙ ПЛАСТИНЫ

Таким Kodu Ordering Code Код для заказа	a (M)	b	d	B	a°	Ürün Detayı / Product Detail / ОПИСАНИЕ
AAV-01-M3x10	M3x0.5	10	5.9	2	90°	T-SİSTEM için / For T-SYSTEM / Т-ТИП WNMG 06, KNUX 16
AAV-02-M5X12	M5x0.8	12	7	3	56°	T-SİSTEM için / For T-SYSTEM / Т-ТИП CNMG 12, WNMG 08, TNMG 22, DNMG 15, SNMG 12
AAV-05-M6X15	M6x1.0	16	9	4	60°	T-SİSTEM için / For T-SYSTEM / Т-ТИП CNMG 16, SNMG 15
AKV-12-M5X12	M5x0.8	12	7.8	3	90°	C-SİSTEM için / For C-SYSTEM / С-ТИП CTSPR Baskı Pabuç Vidası / Clamp Screw / ВИНТ ДЛЯ ПРИЖИМА
AKV-16-M6X16	M6x1.0	16	10	4	76°	C-SİSTEM için / For C-SYSTEM / С-ТИП CTFPR 13CS 16 Baskı Pabuç Vidası / Clamp Screw / ВИНТ ДЛЯ ПРИЖИМА
AAV-13-M5X8	M5x0.8	8	7	3	56°	T-SİSTEM için / For T-SYSTEM / Т-ТИП S25S TSKNR/L 12, S25S TCLNR/L 12, S25S TWLNR/L 08, S25S TDUNR/L 15
AAV-14-M5X14	M5x0.8	14	8.8	3	45°	ADCR için / For ADCR / ADCR-ТИП ADCR Montaj Vidası / Mounting Screw / ADCR Монтажный винт

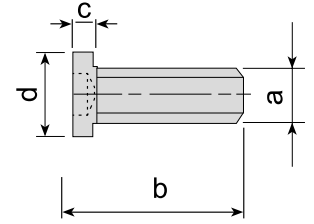
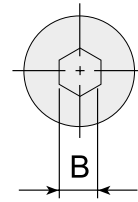

ALTIK VİDALARI / SHIM SCREWS / ВИНТ ДЛЯ ОПОРНОЙ ПЛАСТИНЫ

Takım Kodu Ordering Code Код для заказа						Ürün Detayı / Product Detail / ОПИСАНИЕ	
	a (M)	b	c	d	B		
AAV-03-M5X12	M5X0.8	12	1.4	6	3	T-SİSTEM için / For T-SYSTEM / T-ТИП	TNMG 16
						C-SİSTEM için / For C-SYSTEM / C-ТИП	TNGN 16
AAV-04-M5X12	M5X0.8	12	1.2	6.5	3	T-SİSTEM için / For T-SYSTEM / T-ТИП	VNMG 16, DNMG 11, CNMG 09
AAV-09-M5X9	M5X0.8	9	1.4	6	3	T-SİSTEM için / For T-SYSTEM / T-ТИП	S25S TCLNR/L 09, S25S TDUNR/L 11, S25S TDQNR/L 11

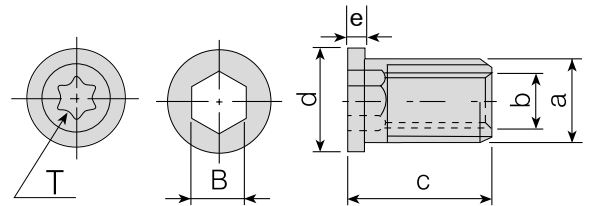

BUKSE VİDALAR / BUKSE SCREWS / КРЕПЁЖНЫЙ ВИНТ ФАСОЧНЫХ КОЛЕЦ

Takım Kodu Ordering Code Код для заказа							Ürün Detayı / Product Detail / ОПИСАНИЕ	
	a (M)	b	c	d	B(T)	e		
AAV-06-M3.5X11	M5x0.5	M3.5x0.6	11.3	6	3.5	1.2	S-SİSTEM için / For S-SYSTEM / S-ТИП	CCMT 09, DCMT 11, VBMT 16, VCMT 16, TCMT 16, SCMT 09, 16 ER/L, 16 IR/L
AAV-07-M4.5X13	M6X0.75	M4.5X0.75	13	7.5	4.5	1.6	S-SİSTEM için / For S-SYSTEM / S-ТИП	CCMT 12, SCMT 12, 22 ER/L, 22 IR/L
AAV-08-M3.5X8	M5X0.5	M3.5x0.6	8	6	20	1.2	S-SİSTEM için / For S-SYSTEM / S-ТИП	Ø25 DCMT 11, Ø25-Ø32 CCMT 09, Ø25 TCMT 16, S25S-S32T SVJBR/L 16,
AAV-10-M4.5X8	M6X0.75	M4.5X0.75	8	7.5	4.5	1.05	S-SİSTEM için / For S-SYSTEM / S-ТИП	Ø25-Ø32 CCMT 12, Ø25-Ø32 SCMT 12, SSSCN 1616 H12, SSSCR/L 1616 H12, SIR/L S25R 22
AAV-16-M3.5X8	M5X0.5	M3.5x0.6	8	6	20	1.1	S-SİSTEM için / For S-SYSTEM / S-ТИП	SEMT 13

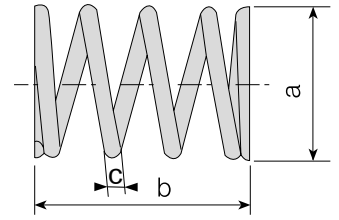
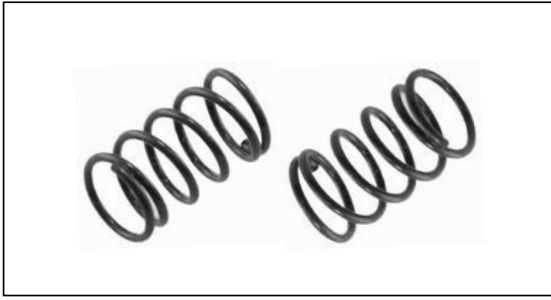

Takım Kodu Ordering Code Код для заказа	BASKI YAYI / CLAMP SPRING / ПРУЖИНЫ			Ürün Detayı / Product Detail / ОПИСАНИЕ	
	a	b	c		
AKY-01	7.7	11.2	0.9	T-SİSTEM için / For T-SYSTEM / Т-ТИП	CNMG 12, WNMG 08, TNMG 22, DNMG 15, SNMG 12, VNMG 16
AKY-02	8.5	13.5	0.7	C-SİSTEM için / For C-SYSTEM / С-ТИП	KNUX 16

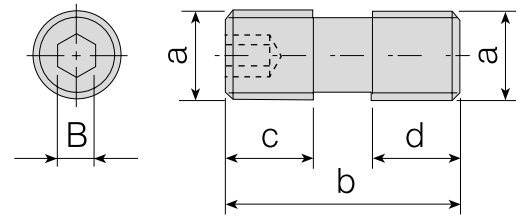

Takım Kodu Ordering Code Код для заказа	BASKI PABUÇ VİDALARI / CLAMP SCREWS / ВИНТЫ ДЛЯ ПРИЖИМОВ					Ürün Detayı / Product Detail / ОПИСАНИЕ	
	a (M)	b	c	d	B		
AKV-13-M8X1X16	M8x1.0	16	6.8	6.8	4	C-SİSTEM FREZELEME için / MILLING For C- SYSTEM / С-ТИП ПРИЖИМ	SPKN 12, Ø63 TPKN 16
AKV-14-M8X1X18	M8x1.0	18	8	8	4	C-SİSTEM FREZELEME için / MILLING For C- SYSTEM / С-ТИП ПРИЖИМ	Ø80-Ø100 TPKN 16, Ø63-Ø315 TPKN 22
AKV-15-M8X1X20	M8x1.0	20	8.5	8.5	4	C-SİSTEM FREZELEME için / MILLING For C- SYSTEM / С-ТИП ПРИЖИМ	OFKR 07, HNMX 09
AKV-18-M5X14	M5X0.8	15	5	6.8	2.5	C-SİSTEM FREZELEME için / MILLING For C- SYSTEM / С-ТИП ПРИЖИМ	SN19
AKV-22-M8X1X14	M8x1.0	14	6.8	4.8	4	C-SİSTEM FREZELEME için / MILLING For C- SYSTEM / С-ТИП ПРИЖИМ	Ø50 TPKN 16
AKV-26-M6X0.75X20	M6x0.75	20	8.5	8.5	3	C-SİSTEM FREZELEME için / MILLING For C- SYSTEM / С-ТИП ПРИЖИМ	AFM45C-XN0806

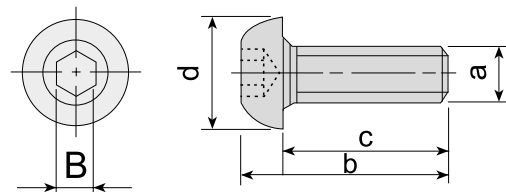

KANAL KATER ve MANTAR VİDALAR / GROOVING TOOL and CLAMP SCREWS / ДЕРЖАВКА ДЛЯ ОБРАБОТКИ КАНАВOK и ВИНТ ПРИХВАТА

Takım Kodu Ordering Code Код для заказа	Kanal Kater ve Mantar Vidalar / Grooving Tool and Clamp Screws / Державка для обработки канавок и винт прихвата					Ürün Detayı / Product Detail / ОПИСАНИЕ
	a (M)	b	c	d	B	
1904-M8X1X20	M8X1.0	25.9	20	11.3	4	S-SİSTEM için / For S-SYSTEM / S-ТИП RCMT 32 Sıkma Vidası / Clamp Screw / Зажимной винт
2004-M8X1X20	M8X1.0	25.9	20	11.4	4	KANAL KATER için / For EXTERNAL GROOVING / ДЛЯ КАНАВочных ДЕРЖАВОК Kanal Kater Vidası / External Grooving Tools Screw / ДЛЯ НЕКОТОРЫХ КАНАВочных ДЕРЖАВОК
2004-M8X20	M8X1.25	30	25	25	4	KANAL KATER için / For EXTERNAL GROOVING / ДЛЯ КАНАВочных ДЕРЖАВОК Eski Kanal Kater Vidası / Old External Grooving Tools Screw / ДЛЯ НЕКОТОРЫХ КАНАВочных ДЕРЖАВОК
AKV-08-M6X12	M6x1.0	17	12	14.3	4	C-SİSTEM FREZELEME için / MILLING For C-SYSTEM / C-ТИП ПРИЖИМ Baskı ve Sıkma Vidası, Mantar Vida / Clamp Screw / Винт прижима
AKV-09-M8X18	M8X1.0	24	18	17.2	5	C-SİSTEM FREZELEME için / MILLING For C-SYSTEM / C-ТИП ПРИЖИМ Baskı ve Sıkma Vidası, Mantar Vida / Clamp Screw / Винт прижима

LEVYELER / LEVERS / РЫЧАГИ

Ürün Resmi Product Picture Изображение продукта	Ürün Kodu Product Code / КОД	Ürün Detayı / Product Detail / ОПИСАНИЕ	
		APL-01	P-SİSTEM için / For P-SYSTEM / P-ТИП
APL-02		P-SİSTEM için / For P-SYSTEM / P-ТИП	CNMG 12, SNMG 12, TNMG 22, WNMG 08 LEVYESİ / LEVER / РЫЧАГИ
APL-03		P-SİSTEM için / For P-SYSTEM / P-ТИП	DNMG 15 LEVYESİ / LEVER / РЫЧАГИ
APL-04		P-SİSTEM için / For P-SYSTEM / P-ТИП	CNMG 16, SNMG 15 LEVYESİ / LEVER / РЫЧАГИ
APL-05		P-SİSTEM için / For P-SYSTEM / P-ТИП	CNMG 19, SNMG 19 LEVYESİ / LEVER / РЫЧАГИ
APL-06		P-SİSTEM için / For P-SYSTEM / P-ТИП	CNMG 25, SNMG 25 LEVYESİ / LEVER / РЫЧАГИ
APL-07		P-SİSTEM için / For P-SYSTEM / P-ТИП	S16P PCLNR/L 09 LEVYESİ / LEVER / РЫЧАГИ
APL-08		P-SİSTEM için / For P-SYSTEM / P-ТИП	S16P PTUNR/L 16 LEVYESİ / LEVER / РЫЧАГИ

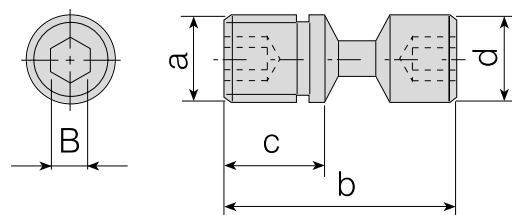

LEVYE VİDALARI / LEVER SCREWS / ФУТОРКА (ВИНТ ОПОРНОЙ ПЛАСТИН)

Takım Kodu Ordering Code Код для заказа	Levyevi Vidaları / Lever Screws / Футорка (винт опорной пластины)					Ürün Detayı / Product Detail / ОПИСАНИЕ
	a (M)	b	c	d	B	
ALV-01-M6X14	M6x1.0	14	10	5.85	2.5	P-SİSTEM için / For P-SYSTEM / P-ТИП S20R PCLNR/L 09, S20R PDUNR/L 11, S20R PDQNR/L 11, S20R PVLNR/L 06, S20R PTUNR/L 16
ALV-02-M6X17	M6x1.0	17	10	5.85	2.5	P-SİSTEM için / For P-SYSTEM / P-ТИП CNMG 09, DNMG 11, SNMG 09, TNMG 16, WNMG 06
ALV-03-M8X19	M8X1.0	19.8	11	7.9	3	P-SİSTEM için / For P-SYSTEM / P-ТИП CNMG 12, SNMG 12, TNMG 22, WNMG 08, DNMG 15
ALV-04-M8X22	M8X1.0	21.5	13	7.75	3	P-SİSTEM için / For P-SYSTEM / P-ТИП CNMG 16, SNMG 15
ALV-05-M10X27	M10X1.0	27.5	15	9.9	4	P-SİSTEM için / For P-SYSTEM / P-ТИП CNMG 19, SNMG 19
ALV-06-M12X36	M12X1.0	36	20	12	5	P-SİSTEM için / For P-SYSTEM / P-ТИП CNMG 25, SNMG 25
ALV-07-M6X13	M6X0.1	12.6	6.5	5.9	2.5	P-SİSTEM için / For P-SYSTEM / P-ТИП S16P PCLNR/L 09, S16P PTUNR/L 16
ALV-08-M8X16	M8X1.0	16	10	7.9	3	P-SİSTEM için / For P-SYSTEM / P-ТИП S25S PCLNR/L 12, S25S PDUNR/L 15, S25S PSKNR/L 12

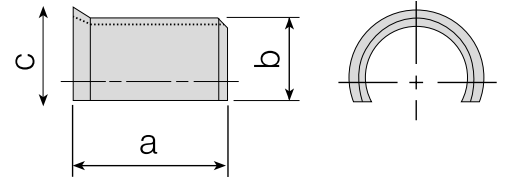

ALTLIK YAYLARI / SHIM SPRINGS / ВТУЛКА РЫЧАГА

Takım Kodu Ordering Code Код для заказа	a	b	c	Ürün Detayı / Product Detail / ОПИСАНИЕ	
				Ürün Detayı / Product Detail / ОПИСАНИЕ	Ürün Detayı / Product Detail / ОПИСАНИЕ
AAV-01	5.6	4.9	6	P-SİSTEM için / For P-SYSTEM / P-ТИП	CNMG 09 ,DNMG 11 ,SNMG 09 ,TNMG 16 ,WNMG 06
AAV-02	6	6.9	7.9	P-SİSTEM için / For P-SYSTEM / P-ТИП	CNMG 12 ,SNMG 12 ,TNMG 22 ,WNMG 08 ,DNMG 15
AAV-03	8.9	8	9.5	P-SİSTEM için / For P-SYSTEM / P-ТИП	CNMG 16 ,SNMG 15
AAV-04	11	9.8	10.7	P-SİSTEM için / For P-SYSTEM / P-ТИП	CNMG 19 ,SNMG 19
AAV-05	12	13	15	P-SİSTEM için / For P-SYSTEM / P-ТИП	CNMG 25 ,SNMG 25

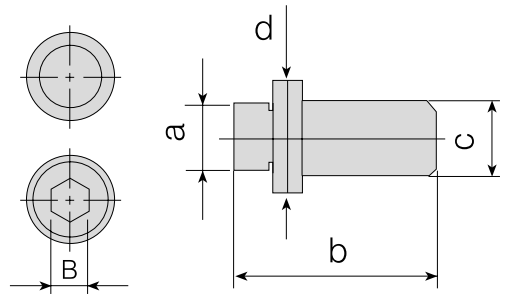

PİMLER / PINS / ШТИФТЫ

Takım Kodu Ordering Code Код для заказа	a	b	c	d	B	Ürün Detayı / Product Detail / ОПИСАНИЕ	
						Ürün Detayı / Product Detail / ОПИСАНИЕ	Ürün Detayı / Product Detail / ОПИСАНИЕ
APM-01	3.55	18	5	6	-	M-SİSTEM için / For M-SYSTEM / M-ТИП	Delik İçi / Internal / Для Внутренних Обработок Ø32-Ø40 TNMG 16 / Dış Çap / External / Для Наружных Обработок TNMG 16
APM-02	5	18	6	7.3	-	M-SİSTEM için / For M-SYSTEM / M-ТИП	TNMG 22 , WNMG 08
APM-03	3.5	12	5	6.5	-	M-SİSTEM için / For M-SYSTEM / M-ТИП	S20R MTFNR/L 16, S20R MT-NR/L 16, S20R MTUNR/L 16, S20R MTQNR/L 16, S20R MDUNR/L 11
APM-04	5	15	6	7.3	-	M-SİSTEM için / For M-SYSTEM / M-ТИП	S32T MCLNR/L 12, DNMG 15, S25S MWLNR/L 08
APM-05	5	11.5	6.5	6.5	3	M-SİSTEM için / For M-SYSTEM / M-ТИП	MSYNR 11.5CS 12 Kartuş için / for Cartridge / Для картриджа
APM-06	3	15.7	-	-	-	C-SİSTEM için / For C-SYSTEM / C-ТИП	154.91
APM-07	3.5	11.5	6.5	6.5	3	M-SİSTEM için / For M-SYSTEM / M-ТИП	S20R ET-NR 16
APM-08	3.5	12	5	5.4	-	M-SİSTEM için / For M-SYSTEM / M-ТИП	S25S MWLNR/L 06, Dış Çap / External / Для Наружных Обработок
APM-09	3.5	10	5	5.4	-	M-SİSTEM için / For M-SYSTEM / M-ТИП	S16P MWLNR/L 06
APM-10	3.5	11	5	5.4	-	M-SİSTEM için / For M-SYSTEM / M-ТИП	S20R MWLNR/L 06
APM-11	3.5	11	5	6.5	-	M-SİSTEM için / For M-SYSTEM / M-ТИП	S20R MTQNR/L 16
APM-12	5	12	6	7.3	-	M-SİSTEM için / For M-SYSTEM / M-ТИП	S20R MCLNR/L 12, S25S MCLNR/L 12-Z
APM-13	5	14	6	7.3	-	M-SİSTEM için / For M-SYSTEM / M-ТИП	S25S MCLNR/L 12
APM-14	3.55	15	5	6	-	M-SİSTEM için / For M-SYSTEM / M-ТИП	S25S MTFNR/L 16, S25S MT-NR/L 16, S25S MTUNR/L 16, S25S MTQNR/L 16
APM-15	4.40	16	6.40	6.40	3	M-SİSTEM için / For M-SYSTEM / M-ТИП	MSYNR 16CS 12 Kartuş için / for Cartridge / Для картриджа

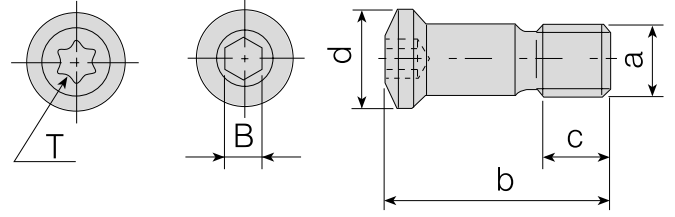

KÜRESEL FİNİŞ VİDALARI / BALL NOSE SCREWS / ВИНТЫ С ПРОТОЧКОЙ

Takım Kodu Ordering Code Код для заказа	KÜRESEL FİNİŞ VİDALARI / BALL NOSE SCREWS / ВИНТЫ С ПРОТОЧКОЙ					Ürün Detayı / Product Detail / ОПИСАНИЕ	
	a (M)	b	c	d	B(T)		
1208-M3x7	M3x0.5	6.9	2.7	4.1	8	KÜRESEL FREZE VİDASI / BALL NOSE SCREW / ВИНТ С ПРОТОЧКОЙ	P3208
1215-M4X0.5X9	M4X0.5	8.6	3.2	5.75	15	KÜRESEL FREZE VİDASI / BALL NOSE SCREW / ВИНТ С ПРОТОЧКОЙ	P3210-ROHX 12
1220-M5X0.5X9	M5X0.5	9.6	3.4	6.8	20	KÜRESEL FREZE VİDASI / BALL NOSE SCREW / ВИНТ С ПРОТОЧКОЙ	P3212
1220-M5X0.5X12	M5X0.5	12.9	4.4	7.4	20	KÜRESEL FREZE VİDASI / BALL NOSE SCREW / ВИНТ С ПРОТОЧКОЙ	P3216-ROHX 16
1220-M5X0.5X15	M5X0.5	16.4	6	7.8	20	KÜRESEL FREZE VİDASI / BALL NOSE SCREW / ВИНТ С ПРОТОЧКОЙ	P3220-ROHX 20
1220-M6X0.75X20	M6X0.75	20	6	9.4	20	KÜRESEL FREZE VİDASI / BALL NOSE SCREW / ВИНТ С ПРОТОЧКОЙ	P3225
1204-M8X0.75X26	M8X0.75	26	7.5	12	4	KÜRESEL FREZE VİDASI / BALL NOSE SCREW / ВИНТ С ПРОТОЧКОЙ	P3232
1210-M3.5X9.6	M3.5X0.6	9.6	4	4.7	10	KÜRESEL FREZE VİDASI / BALL NOSE SCREW / ВИНТ С ПРОТОЧКОЙ	BNM 12
1215-M4X13.5	M4X0.7	13.5	5	5.8	15	KÜRESEL FREZE VİDASI / BALL NOSE SCREW / ВИНТ С ПРОТОЧКОЙ	BNM 16

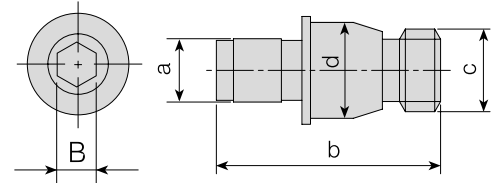
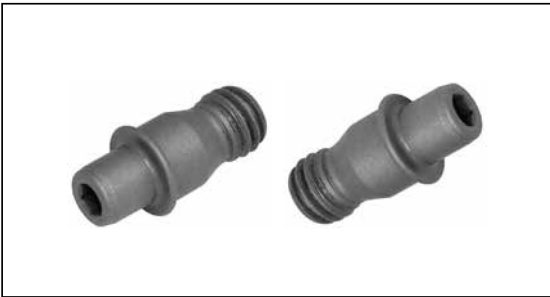

EKSANTRİK VİDA / ECCENTRIC SCREW / ВИНТ С ЭКСЦЕНТРИКОМ

Takım Kodu Ordering Code Код для заказа	EKSANTRİK VİDA / ECCENTRIC SCREW / ВИНТ С ЭКСЦЕНТРИКОМ					Ürün Detayı / Product Detail / ОПИСАНИЕ	
	a	b	c	d	B		
AEV-01-M6x16	4.85	16	M6x1.0	6.5	2.5	Eksantrik Vida / Eccentric Screw / Эксцентрикный винт	PSDNN Kartuş için / for Cartridge / Для картриджа

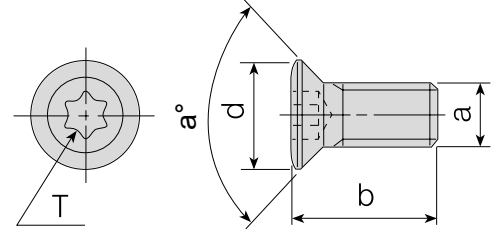

TORK VİDALARI / TORX SCREWS / ВИНТЫ TORX

Takım Kodu Ordering Code Код для заказа	a (M)	b	T	d	a°	Ürün Detayı / Product Detail / ОПИСАНИЕ
4006-M1.6x3.2	M1.6X0.35	3.2	6	2.50	60	S-SİSTEM için / For S-SYSTEM / S-TIPI TORK VİDA / TORX SCREW / TORX ВИНТ
3006-M1.8x4	M1.8X0.35	4	6	2.45	60	S-SİSTEM için / For S-SYSTEM / S-TIPI TORK VİDA / TORX SCREW / TORX ВИНТ
3006-M2x4	M2X0.4	4.3	6	2.7	60	S-SİSTEM için / For S-SYSTEM / S-TIPI TORK VİDA / TORX SCREW / TORX ВИНТ
4006-M2x5	M2X0.4	5	6	3	55	S-SİSTEM için / For S-SYSTEM / S-TIPI TORK VİDA / TORX SCREW / TORX ВИНТ
3007-M2.2x5	M2.2X0.45	5.2	7	3.15	60	S-SİSTEM için / For S-SYSTEM / S-TIPI TORK VİDA / TORX SCREW / TORX ВИНТ
4006-M2.2x5	M2.2X0.45	5	6	2.8	55	S-SİSTEM için / For S-SYSTEM / S-TIPI TORK VİDA / TORX SCREW / TORX ВИНТ
1008-M2.5x5	M2.5X0.45	5.5	8	3.5	45	S-SİSTEM için / For S-SYSTEM / S-TIPI TORK VİDA / TORX SCREW / TORX ВИНТ
1008-M2.5x7	M2.5X0.45	7	8	3.6	45	S-SİSTEM için / For S-SYSTEM / S-TIPI TORK VİDA / TORX SCREW / TORX ВИНТ
1108-M2.5x6	M2.5X0.45	6	8	3.9	R	S-SİSTEM için / For S-SYSTEM / S-TIPI TORK VİDA / TORX SCREW / TORX ВИНТ
3008-M2.5x5	M2.5X0.45	5	8	3.5	60	S-SİSTEM için / For S-SYSTEM / S-TIPI TORK VİDA / TORX SCREW / TORX ВИНТ
3008-M2.5x6	M2.5X0.45	6	8	3.5	60	S-SİSTEM için / For S-SYSTEM / S-TIPI TORK VİDA / TORX SCREW / TORX ВИНТ
4008-M2.5x4	M2.5X0.45	4	8	3.5	45	S-SİSTEM için / For S-SYSTEM / S-TIPI TORK VİDA / TORX SCREW / TORX ВИНТ
4008-M2.5x4.5	M2.5X0.45	4.5	8	3.5	45	S-SİSTEM için / For S-SYSTEM / S-TIPI TORK VİDA / TORX SCREW / TORX ВИНТ
4008-M2.5x6	M2.5X0.45	5.8	8	3.5	45	S-SİSTEM için / For S-SYSTEM / S-TIPI TORK VİDA / TORX SCREW / TORX ВИНТ
4008-M2.5x6.5	M2.5X0.45	6.5	8	4	60	S-SİSTEM için / For S-SYSTEM / S-TIPI TORK VİDA / TORX SCREW / TORX ВИНТ
4108-M2.5x6.5	M2.5X0.45	6.5	8	3.5	50	S-SİSTEM için / For S-SYSTEM / S-TIPI TORK VİDA / TORX SCREW / TORX ВИНТ
4108-M2.5x8	M2.5X0.45	8	8	3.5	50	S-SİSTEM için / For S-SYSTEM / S-TIPI TORK VİDA / TORX SCREW / TORX ВИНТ
1008-M3x6	M3X0.5	6	8	4	60	S-SİSTEM için / For S-SYSTEM / S-TIPI TORK VİDA / TORX SCREW / TORX ВИНТ
1008-M3x8	M3X0.5	8	8	3.9	60	S-SİSTEM için / For S-SYSTEM / S-TIPI TORK VİDA / TORX SCREW / TORX ВИНТ
1108-M3x6.8	M3X0.5	6.8	8	4	60	S-SİSTEM için / For S-SYSTEM / S-TIPI TORK VİDA / TORX SCREW / TORX ВИНТ
3008-M3x6	M3X0.5	6	8	4	45	S-SİSTEM için / For S-SYSTEM / S-TIPI TORK VİDA / TORX SCREW / TORX ВИНТ
3008-M3x7	M3X0.5	7	8	4	55	S-SİSTEM için / For S-SYSTEM / S-TIPI TORK VİDA / TORX SCREW / TORX ВИНТ
3008-M3x8	M3X0.5	8	8	4	45	S-SİSTEM için / For S-SYSTEM / S-TIPI TORK VİDA / TORX SCREW / TORX ВИНТ
3108-M3x6	M3X0.5	6	8	3.8	60	S-SİSTEM için / For S-SYSTEM / S-TIPI TORK VİDA / TORX SCREW / TORX ВИНТ
3108-M3x8	M3X0.5	8	8	3.8	60	S-SİSTEM için / For S-SYSTEM / S-TIPI TORK VİDA / TORX SCREW / TORX ВИНТ
4008-M3x8	M3X0.5	8	8	4	60	S-SİSTEM için / For S-SYSTEM / S-TIPI TORK VİDA / TORX SCREW / TORX ВИНТ
4010-M3x6	M3X0.5	6	10	4.2	45	S-SİSTEM için / For S-SYSTEM / S-TIPI TORK VİDA / TORX SCREW / TORX ВИНТ
4010-M3x8	M3X0.5	8	10	4.2	45	S-SİSTEM için / For S-SYSTEM / S-TIPI TORK VİDA / TORX SCREW / TORX ВИНТ
1015-M3.5x9	M3.5X0.6	9	15	5.3	60	S-SİSTEM için / For S-SYSTEM / S-TIPI TORK VİDA / TORX SCREW / TORX ВИНТ
1015-M3.5x11	M3.5X0.6	11.1	15	5.3	60	S-SİSTEM için / For S-SYSTEM / S-TIPI TORK VİDA / TORX SCREW / TORX ВИНТ
1015-M3.5x14	M3.5X0.6	14	15	5.3	66	S-SİSTEM için / For S-SYSTEM / S-TIPI TORK VİDA / TORX SCREW / TORX ВИНТ
1015-M3.5x16	M3.5X0.6	16	15	5.3	55	S-SİSTEM için / For S-SYSTEM / S-TIPI TORK VİDA / TORX SCREW / TORX ВИНТ
1315-M3.5x11	M3.5X0.6	10.6	15	7.9	-	S-SİSTEM için / For S-SYSTEM / S-TIPI TORK VİDA / TORX SCREW / TORX ВИНТ
1510-M3.5x7	M3.5X0.6	7.1	10	5.1	55	S-SİSTEM için / For S-SYSTEM / S-TIPI TORK VİDA / TORX SCREW / TORX ВИНТ
1510-M3.5x9	M3.5X0.6	9.1	10	5	55	S-SİSTEM için / For S-SYSTEM / S-TIPI TORK VİDA / TORX SCREW / TORX ВИНТ
1615-M3.5x10	M3.5X0.6	10	15	5.8	60	S-SİSTEM için / For S-SYSTEM / S-TIPI TORK VİDA / TORX SCREW / TORX ВИНТ
1615-M3.5x11	M3.5X0.6	11	15	5.8	60	S-SİSTEM için / For S-SYSTEM / S-TIPI TORK VİDA / TORX SCREW / TORX ВИНТ
1615-M3.5x15	M3.5X0.6	15	15	5.8	60	S-SİSTEM için / For S-SYSTEM / S-TIPI TORK VİDA / TORX SCREW / TORX ВИНТ
3010-M3.5x7	M3.5X0.6	7	10	5	55	S-SİSTEM için / For S-SYSTEM / S-TIPI TORK VİDA / TORX SCREW / TORX ВИНТ
3010-M3.5x9	M3.5X0.6	9	10	5	55	S-SİSTEM için / For S-SYSTEM / S-TIPI TORK VİDA / TORX SCREW / TORX ВИНТ
3015-M3.5x9	M3.5X0.6	8.8	15	5.4	60	S-SİSTEM için / For S-SYSTEM / S-TIPI TORK VİDA / TORX SCREW / TORX ВИНТ
4015-M3.5x8	M3.5X0.6	7.9	15	5.3	55	S-SİSTEM için / For S-SYSTEM / S-TIPI TORK VİDA / TORX SCREW / TORX ВИНТ
4015-M3.5x9	M3.5X0.6	8.7	15	5.3	60	S-SİSTEM için / For S-SYSTEM / S-TIPI TORK VİDA / TORX SCREW / TORX ВИНТ
4015-M3.5x10	M3.5X0.6	9.8	15	5.3	60	S-SİSTEM için / For S-SYSTEM / S-TIPI TORK VİDA / TORX SCREW / TORX ВИНТ
4015-M3.5x11	M3.5X0.6	10.7	15	5.3	60	S-SİSTEM için / For S-SYSTEM / S-TIPI TORK VİDA / TORX SCREW / TORX ВИНТ

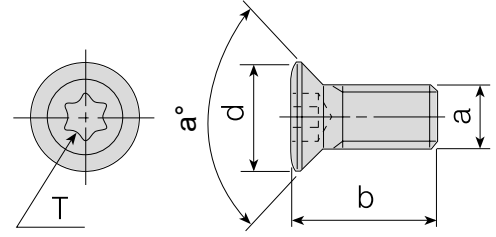

TORK VİDALARI / TORX SCREWS / ВИНТЫ TORX

Такım Kodu Ordering Code Код для заказа	a (M)	b	T	d	a°	Ürün Detayı / Product Detail / ОПИСАНИЕ
4015-M3.5x12	M3.5X0.6	12	15	5.3	60	S-SİSTEM için / For S-SYSTEM / S-ТИП TORK VİDA / TORX SCREW / TORX ВИНТ
4015-M3.5x14	M3.5X0.6	13.7	15	5.3	60	S-SİSTEM için / For S-SYSTEM / S-ТИП TORK VİDA / TORX SCREW / TORX ВИНТ
1015-M4x8	M4X0.7	8	15	6.8	R	S-SİSTEM için / For S-SYSTEM / S-ТИП TORK VİDA / TORX SCREW / TORX ВИНТ
1015-M4x9	M4X0.7	9	15	6.8	R	S-SİSTEM için / For S-SYSTEM / S-ТИП TORK VİDA / TORX SCREW / TORX ВИНТ
1515-M4x9	M4X0.7	9	15	5.7	50	S-SİSTEM için / For S-SYSTEM / S-ТИП TORK VİDA / TORX SCREW / TORX ВИНТ
1015-M4x11	M4X0.7	10.8	15	6.8	R	S-SİSTEM için / For S-SYSTEM / S-ТИП TORK VİDA / TORX SCREW / TORX ВИНТ
1115-M4x10	M4X0.7	10	15	5.9	R	S-SİSTEM için / For S-SYSTEM / S-ТИП TORK VİDA / TORX SCREW / TORX ВИНТ
1315-M4x11	M4X0.7	11.1	15	5	45	S-SİSTEM için / For S-SYSTEM / S-ТИП TORK VİDA / TORX SCREW / TORX ВИНТ
1415-M4x11	M4X0.7	11	15	5.6	50	S-SİSTEM için / For S-SYSTEM / S-ТИП TORK VİDA / TORX SCREW / TORX ВИНТ
1515-M4x11	M4X0.7	11.1	15	5.6	50	S-SİSTEM için / For S-SYSTEM / S-ТИП TORK VİDA / TORX SCREW / TORX ВИНТ
1615-M4x11	M4X0.7	11.1	15	6	50	S-SİSTEM için / For S-SYSTEM / S-ТИП TORK VİDA / TORX SCREW / TORX ВИНТ
3015-M4x9	M4X0.7	9	15	5.6	50	S-SİSTEM için / For S-SYSTEM / S-ТИП TORK VİDA / TORX SCREW / TORX ВИНТ
3015-M4x11	M4X0.7	11	15	5.6	50	S-SİSTEM için / For S-SYSTEM / S-ТИП TORK VİDA / TORX SCREW / TORX ВИНТ
4015-M4x9	M4X0.7	9	15	5.6	50	S-SİSTEM için / For S-SYSTEM / S-ТИП TORK VİDA / TORX SCREW / TORX ВИНТ
4015-M4x10	M4X0.7	10	15	5.6	50	S-SİSTEM için / For S-SYSTEM / S-ТИП TORK VİDA / TORX SCREW / TORX ВИНТ
4015-M4x11	M4X0.7	11	15	5.6	50	S-SİSTEM için / For S-SYSTEM / S-ТИП TORK VİDA / TORX SCREW / TORX ВИНТ
4015-M4x12	M4X0.7	12	15	5.7	50	S-SİSTEM için / For S-SYSTEM / S-ТИП TORK VİDA / TORX SCREW / TORX ВИНТ
4115-M4x12	M4X0.7	12	15	5.6	55	S-SİSTEM için / For S-SYSTEM / S-ТИП TORK VİDA / TORX SCREW / TORX ВИНТ
4515-M4x8	M4X0.7	8	15	5.1	50	S-SİSTEM için / For S-SYSTEM / S-ТИП TORK VİDA / TORX SCREW / TORX ВИНТ
4515-M4x11	M4X0.7	11	15	5.1	50	S-SİSTEM için / For S-SYSTEM / S-ТИП TORK VİDA / TORX SCREW / TORX ВИНТ
4615-M4x11	M4X0.7	11	15	6	50	S-SİSTEM için / For S-SYSTEM / S-ТИП TORK VİDA / TORX SCREW / TORX ВИНТ
1015-M4.5x12	M4.5X0.75	12	15	6.6	50	S-SİSTEM için / For S-SYSTEM / S-ТИП TORK VİDA / TORX SCREW / TORX ВИНТ
1020-M4.5x14	M4.5X0.75	14	20	6.5	45	S-SİSTEM için / For S-SYSTEM / S-ТИП TORK VİDA / TORX SCREW / TORX ВИНТ
1020-M4.5x16	M4.5X0.75	16	20	6.5	45	S-SİSTEM için / For S-SYSTEM / S-ТИП TORK VİDA / TORX SCREW / TORX ВИНТ
1120-M4.5x12	M4.5X0.75	12.1	20	7.9	R	S-SİSTEM için / For S-SYSTEM / S-ТИП TORK VİDA / TORX SCREW / TORX ВИНТ
1515-M4.5x11	M4.5X0.75	11	15	6.4	45	S-SİSTEM için / For S-SYSTEM / S-ТИП TORK VİDA / TORX SCREW / TORX ВИНТ
4015-M4.5x11	M4.5X0.75	11	15	6.4	45	S-SİSTEM için / For S-SYSTEM / S-ТИП TORK VİDA / TORX SCREW / TORX ВИНТ
4020-M4.5x10	M4.5X0.75	10	20	6.5	55	S-SİSTEM için / For S-SYSTEM / S-ТИП TORK VİDA / TORX SCREW / TORX ВИНТ
4020-M4.5x12	M4.5X0.75	12	20	6.5	55	S-SİSTEM için / For S-SYSTEM / S-ТИП TORK VİDA / TORX SCREW / TORX ВИНТ
1020-M5x11	M5X0.8	11	20	6.6	50	S-SİSTEM için / For S-SYSTEM / S-ТИП TORK VİDA / TORX SCREW / TORX ВИНТ
1020-M5x14	M5X0.8	14.1	20	6.8	50	S-SİSTEM için / For S-SYSTEM / S-ТИП TORK VİDA / TORX SCREW / TORX ВИНТ
1120-M5x13	M5X0.8	13	20	7	R	S-SİSTEM için / For S-SYSTEM / S-ТИП TORK VİDA / TORX SCREW / TORX ВИНТ
1615-M5x14	M5X0.8	14	15	7.3	50	S-SİSTEM için / For S-SYSTEM / S-ТИП TORK VİDA / TORX SCREW / TORX ВИНТ
1620-M5x18	M5X0.8	18	20	8.15	50	S-SİSTEM için / For S-SYSTEM / S-ТИП TORK VİDA / TORX SCREW / TORX ВИНТ
1620-M5x22	M5X0.8	22	20	8.15	50	S-SİSTEM için / For S-SYSTEM / S-ТИП TORK VİDA / TORX SCREW / TORX ВИНТ
4420-M5x14	M5X0.8	14	20	6.60	60	S-SİSTEM için / For S-SYSTEM / S-ТИП TORK VİDA / TORX SCREW / TORX ВИНТ
1020-M6x16	M6X1.0	16	20	8.5	50	S-SİSTEM için / For S-SYSTEM / S-ТИП TORK VİDA / TORX SCREW / TORX ВИНТ
1420-M6x16	M6X1.0	16	20	7.6	50	S-SİSTEM için / For S-SYSTEM / S-ТИП TORK VİDA / TORX SCREW / TORX ВИНТ
1520-M6x16	M6X1.0	16	20	8.2	50	S-SİSTEM için / For S-SYSTEM / S-ТИП TORK VİDA / TORX SCREW / TORX ВИНТ
1710-U5-40x12.2	UNC 5-40	12.2	10	5.6	60	S-SİSTEM için / For S-SYSTEM / S-ТИП TORK VİDA / TORX SCREW / TORX ВИНТ
1720-U8-32x10	UNC 8-32	10	20	7.5	60	S-SİSTEM için / For S-SYSTEM / S-ТИП TORK VİDA / TORX SCREW / TORX ВИНТ
1720-U8-32x15	UNC 8-32	15	20	7.5	60	S-SİSTEM için / For S-SYSTEM / S-ТИП TORK VİDA / TORX SCREW / TORX ВИНТ
1707-U4-48x6	UNF 4-48	6	7	3.27	60	S-SİSTEM için / For S-SYSTEM / S-ТИП TORK VİDA / TORX SCREW / TORX ВИНТ
1707-U4-48x6.5	UNF 4-48	6.5	7	3.27	60	S-SİSTEM için / For S-SYSTEM / S-ТИП TORK VİDA / TORX SCREW / TORX ВИНТ
1707-U4-48x8.2	UNF 4-48	8.2	7	3.27	60	S-SİSTEM için / For S-SYSTEM / S-ТИП TORK VİDA / TORX SCREW / TORX ВИНТ

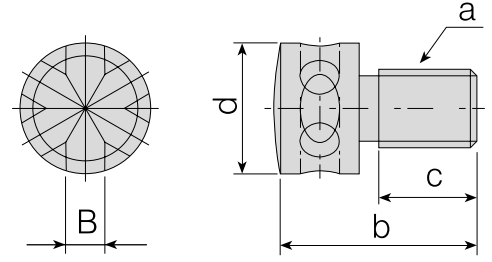

Takım Kodu Ordering Code Код для заказа	EKSENEL AYAR VİDALARI / AXIAL ADJUSTING SCREWS / Осевого регулировочный винт					Ürün Detayı / Product Detail / ОПИСАНИЕ
	a (M)	b	c	d	B	
2600-M4x9.5	M4X0.5	5.5	4	4	1.5	Kartuş için / for Cartridge / Для картриджа
2600-M5x13	M5x0.5	12.8	7	8.7	2.5	Kartuş için / for Cartridge / Для картриджа
2600-M6x18	M6x1.0	18.2	9	10	3.5	Kartuş için / for Cartridge / Для картриджа

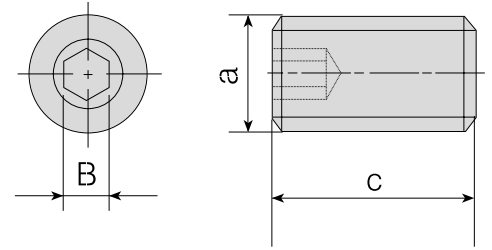

Takım Kodu Ordering Code Код для заказа	RADYAL AYAR VİDALARI / RADIAL ADJUSTING SCREWS / РЕГУЛИРОВОЧНЫЙ ВИНТ			Ürün Detayı / Product Detail / ОПИСАНИЕ
	a (M)	c	B	
2715-M3x4	M3x0.5	4	1.5	KABA BARA için / for ROUGH BORING HEADS ДЛЯ ЧЕРНОВЫХ РАСТОЧНЫХ ГОЛОВОК
2715-M3x5	M3x0.5	5	1.5	KABA BARA için / for ROUGH BORING HEADS ДЛЯ ЧЕРНОВЫХ РАСТОЧНЫХ ГОЛОВОК
2715-M3x8	M3x0.5	8	1.5	KABA BARA için / for ROUGH BORING HEADS ДЛЯ ЧЕРНОВЫХ РАСТОЧНЫХ ГОЛОВОК
2702-M4x4	M4x0.7	4	2	KARTUŞ için / for CARTRIDGE / КАРТРИДЖИ
2702-M4x10	M4x0.7	10	2	KARTUŞ için / for CARTRIDGE / КАРТРИДЖИ
2702-M4x12	M4x0.7	12	2	KABA BARA için / for ROUGH BORING HEADS ДЛЯ ЧЕРНОВЫХ РАСТОЧНЫХ ГОЛОВОК
2725-M5x6	M5x0.8	5	2.5	KARTUŞ için / for CARTRIDGE / КАРТРИДЖИ
2725-M5x10	M5x0.8	10	2.5	KARTUŞ için / for CARTRIDGE / КАРТРИДЖИ
2725-M5x12	M5x0.8	12	2.5	KABA BARA için / for ROUGH BORING HEADS ДЛЯ ЧЕРНОВЫХ РАСТОЧНЫХ ГОЛОВОК
2725-M5x14	M5x0.8	14	2.5	KABA BARA için / for ROUGH BORING HEADS ДЛЯ ЧЕРНОВЫХ РАСТОЧНЫХ ГОЛОВОК
2703-M6x16	M6x1	16	3	KABA BARA için / for ROUGH BORING HEADS ДЛЯ ЧЕРНОВЫХ РАСТОЧНЫХ ГОЛОВОК
2704-M8x25	M8x1.25	25.9	4	KABA BARA için / for ROUGH BORING HEADS ДЛЯ ЧЕРНОВЫХ РАСТОЧНЫХ ГОЛОВОК

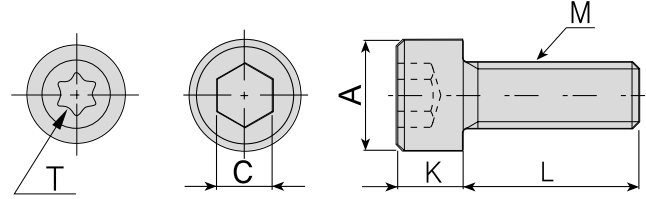

İNBUS CİVATALAR / INBUS SCREWS / ВИНТЫ С ПОТАЙНОЙ ГОЛОВКОЙ

Takım Kodu Ordering Code Код для заказа						Ürün Detayı / Product Detail / ОПИСАНИЕ	
	M	A	C	K	L		
2503-M4x10	M4x0.7	6.85	3	4	10	KANAL KATER VİDASI / SOME GROOVING TOOLS SCREW	ДЛЯ НЕКОТОРЫХ КАНАВОЧНЫХ ДЕРЖАВОК
2525-M3X14	M3X0.5	5.4	2.5	2.9	14	BARA KARTUŞU için SIKMA VİDASI / for BORING HEADS CARTRIDGE SCREW	ВИНТ ДЛЯ КАРТРИДЖЕЙ РАСТОЧНЫХ ГОЛОВОК
2503-M4X20	M4x0.7	7	3	3.9	20	BARA KARTUŞU için SIKMA VİDASI / for BORING HEADS CARTRIDGE SCREW	ВИНТ ДЛЯ КАРТРИДЖЕЙ РАСТОЧНЫХ ГОЛОВОК
2503-M4X12	M4x0.7	6.85	3	4	12	KANAL KATER VİDASI / SOME GROOVING TOOLS SCREW	ДЛЯ НЕКОТОРЫХ КАНАВОЧНЫХ ДЕРЖАВОК
2503-M4X15	M4x0.7	6.85	3	4	15	BARA KARTUŞU için SIKMA VİDASI / for BORING HEADS CARTRIDGE SCREW	ВИНТ ДЛЯ КАРТРИДЖЕЙ РАСТОЧНЫХ ГОЛОВОК
2504-M5X16	M5X0.8	8.5	4	5	16	KANAL KATER VİDASI / SOME GROOVING TOOLS SCREW	ДЛЯ НЕКОТОРЫХ КАНАВОЧНЫХ ДЕРЖАВОК
2504-M5X12	M5X0.8	8.5	4	5	12	KANAL KATER VİDASI / SOME GROOVING TOOLS SCREW	ДЛЯ НЕКОТОРЫХ КАНАВОЧНЫХ ДЕРЖАВОК
2504-M5X25	M5X0.8	8.5	4	5	25	BARA KARTUŞU için SIKMA VİDASI / for BORING HEADS CARTRIDGE SCREW	ВИНТ ДЛЯ КАРТРИДЖЕЙ РАСТОЧНЫХ ГОЛОВОК
2505-M6X16	M6X1	9.9	5	6	16	KANAL KATER VİDASI / SOME GROOVING TOOLS SCREW	ДЛЯ НЕКОТОРЫХ КАНАВОЧНЫХ ДЕРЖАВОК
2505-M6X20	M6X1	9.9	5	6	20	KANAL KATER VİDASI / SOME GROOVING TOOLS SCREW	ДЛЯ НЕКОТОРЫХ КАНАВОЧНЫХ ДЕРЖАВОК
2505-M6X25	M6X1	9.9	5	6	25	BLOK BASKI PABUÇ VİDASI / for BLOCK CLAMP SCREW	ВИНТ ДЛЯ ПРИЖИМА БЛОКОВ
2505-M6X30	M6X1	9.9	5	6	30	BARA KARTUŞU için SIKMA VİDASI / for BORING HEADS CARTRIDGE SCREW	ВИНТ ДЛЯ КАРТРИДЖЕЙ РАСТОЧНЫХ ГОЛОВОК
2405-M8X30	M8X1.25	13	5	5	30	A16 MONTAJ VİDASI (KAFASI KÜÇÜK) / MOUNTING SCREW (SMALL HEAD)	МОНТАЖНЫЙ ВИНТ (МАЛЕНЬКАЯ ГОЛОВКА)
2506-M8X20	M8X1.25	13	6	7.9	20	KARTUŞ MONTAJ VİDASI / CARTRIDGE MOUNTING SCREW	МОНТАЖНЫЙ ВИНТ ДЛЯ КАРТРИДЖА
2506-M8X30	M8X1.25	13	6	7.9	30	A16 MONTAJ VİDASI / MOUNTING SCREW	МОНТАЖНЫЙ ВИНТ (МАЛЕНЬКАЯ ГОЛОВКА)
2506-M8X35	M8X1.25	13	6	7.9	35	BARA KARTUŞU için SIKMA VİDASI / for BORING HEADS CARTRIDGE SCREW	ВИНТ ДЛЯ КАРТРИДЖЕЙ РАСТОЧНЫХ ГОЛОВОК
2406-M8X30	M8X1.25	12	6	7.9	30	A16 MONTAJ VİDASI / MOUNTING SCREW	МОНТАЖНЫЙ ВИНТ (МАЛЕНЬКАЯ ГОЛОВКА)
2407-M10X30	M10X1.5	16	7	6	30	A16 MONTAJ VİDASI / MOUNTING SCREW	МОНТАЖНЫЙ ВИНТ (МАЛЕНЬКАЯ ГОЛОВКА)
2408-M10X30	M10X1.5	13.90	8	10	30	A22 MONTAJ VİDASI / MOUNTING SCREW	МОНТАЖНЫЙ ВИНТ (МАЛЕНЬКАЯ ГОЛОВКА)
2508-M10X30	M10X1.5	16	8	10	30	A22 MONTAJ VİDASI / MOUNTING SCREW	МОНТАЖНЫЙ ВИНТ (МАЛЕНЬКАЯ ГОЛОВКА)
2508-M10X40	M10X1.5	16	8	10	40	BARA KARTUŞU için SIKMA VİDASI / for BORING HEADS CARTRIDGE SCREWS	ВИНТ ДЛЯ КАРТРИДЖЕЙ РАСТОЧНЫХ ГОЛОВОК
2408-M12X35	M12X1.75	18	8	7	35	A27 MONTAJ VİDASI / MOUNTING SCREW	МОНТАЖНЫЙ ВИНТ (МАЛЕНЬКАЯ ГОЛОВКА)
2510-M12X35	M12X1.75	18	10	12	35	A27 MONTAJ VİDASI / MOUNTING SCREW	МОНТАЖНЫЙ ВИНТ (МАЛЕНЬКАЯ ГОЛОВКА)
2514-M16X35	M16X2.0	23.7	14	16	35	A32 MONTAJ VİDASI / MOUNTING SCREW	МОНТАЖНЫЙ ВИНТ (МАЛЕНЬКАЯ ГОЛОВКА)
AAV-11-U5-40x4.5	UNC 5-40	5.4	T10	2.8	4.5	16 ER/L, 16 IR/L ALTLIK VİDASI / SHIM SCREW	ВИНТ ДЛЯ ОПОРНОЙ ПЛАСТИНЫ
AAV-12-U8-32x5.5	UNC 8-32	6.7	T20	3.8	5.5	22 ER/L, 22 IR/L ALTLIK VİDASI / SHIM SCREW	ВИНТ ДЛЯ ОПОРНОЙ ПЛАСТИНЫ
AAV-15-M5x5.7	M5X0.8	8.5	T20	3.15	5.7	27 ER/L, 27 IR/L ALTLIK VİDASI / SHIM SCREW	ВИНТ ДЛЯ ОПОРНОЙ ПЛАСТИНЫ

SEKMAN / RING / КОЛЬЦО

Takım Kodu Ordering Code Код для заказа	Ürün Kodu Product Code / КОД	Ürün Detayı / Product Detail / ОПИСАНИЕ	
		ACS-01	C-SİSTEM için / For C-SYSTEM / С-ТИП
AS-01		T-M-SİSTEM için / For T-M SYSTEM / Т-М ТИП	AKV-30-M6x20 SEKMANI / RING / КОЛЬЦО

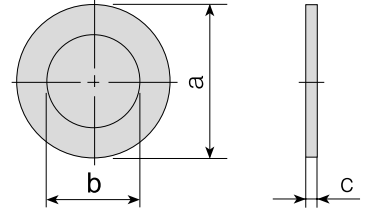
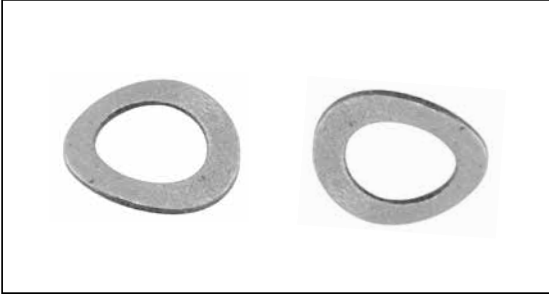

BASKI PULU / STAMP / ШАЙБА

Takım Kodu Ordering Code Код для заказа	a	b	c	Ürün Detayı / Product Detail / ОПИСАНИЕ	
				PUL/STAMP/ШАЙБА	BASKI PULU / ШАЙБА
ABPL-01	11	6.5	0.5	PUL/STAMP/ШАЙБА	BASKI PULU / ШАЙБА
ABPL-02	12.75	7.1	0.45	PUL/STAMP/ШАЙБА	BASKI PULU / ШАЙБА

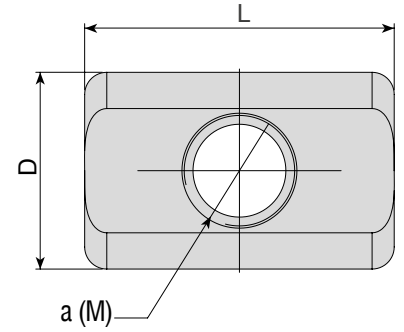

BARA PABUÇLARI / BORING HEADS CARTRIDGE / КАРТРИДЖЕЙ РАСТОЧНЫХ ГОЛОВОК

Takım Kodu Ordering Code Код для заказа	a (M)	D	L	Ürün Detayı / Product Detail / ОПИСАНИЕ	
				KABA BARA için / for ROUGH BORING HEADS / ДЛЯ ЧЕРНОВЫХ РАСТОЧНЫХ ГОЛОВОК	ABHR-D16x42-W16-L90
ABKS-D16	M3x0.5	4.9	6	KABA BARA için / for ROUGH BORING HEADS / ДЛЯ ЧЕРНОВЫХ РАСТОЧНЫХ ГОЛОВОК	ABHR-D16x42-W16-L90
ABKS-D20	M4x0.7	5.9	9	KABA BARA için / for ROUGH BORING HEADS / ДЛЯ ЧЕРНОВЫХ РАСТОЧНЫХ ГОЛОВОК	ABHR-D20x50-W20-L100
ABKS-D25	M4x0.7	5.9	12	KABA BARA için / for ROUGH BORING HEADS / ДЛЯ ЧЕРНОВЫХ РАСТОЧНЫХ ГОЛОВОК	ABHR-D25x60-W20-L110
ABKS-D32	M5x0.8	8.9	14	KABA BARA için / for ROUGH BORING HEADS / ДЛЯ ЧЕРНОВЫХ РАСТОЧНЫХ ГОЛОВОК	ABHR-D32x64-W25-L120
ABKS-D40	M6x1	10.9	18	KABA BARA için / for ROUGH BORING HEADS / ДЛЯ ЧЕРНОВЫХ РАСТОЧНЫХ ГОЛОВОК	ABHR-D40x80-W32-L140
ABKS-D50	M8x1.25	13.9	28	KABA BARA için / for ROUGH BORING HEADS / ДЛЯ ЧЕРНОВЫХ РАСТОЧНЫХ ГОЛОВОК	ABHR-D50x100-W32-L160
ABKS-D63	M10x1.5	15.9	35	KABA BARA için / for ROUGH BORING HEADS / ДЛЯ ЧЕРНОВЫХ РАСТОЧНЫХ ГОЛОВОК	ABHR-D63x80-W32-L140, ABHR-D63x130-W40-L200
ABKS-D80	M12x1.75	17.9	45	KABA BARA için / for ROUGH BORING HEADS / ДЛЯ ЧЕРНОВЫХ РАСТОЧНЫХ ГОЛОВОК	ABHR-D80x140-W40-L210, ABHR-D80x140-W40-L210 -B



Ürün Resmi Product Picture ИЗОБРАЖЕНИЕ	KESME ve KANAL LAMA AÇMA BLOK PABUÇLARI / BLOCKS FOR PARTING AND DEEP GROOVING BLADES CLAMPS ПРИЖИМ БЛОКА СМЕННОГО ЛЕЗВИЯ ДЛЯ ОТРЕЗКИ И ОБРАБОТКИ ГЛУБОКИХ КАНАВOK		
	Ürün Kodu Product Code / КОД	Ürün Detayı / Product Detail / ОПИСАНИЕ	
	ABK-01	LAMA BLOĞU için / For BLADE BLOCK / ДЛЯ БЛОКА СМЕННОГО ЛЕЗВИЯ	ALBU-20-26 BASKI PABUCU / CLAMP / Прижим
	ABK-02	LAMA BLOĞU için / For BLADE BLOCK / ДЛЯ БЛОКА СМЕННОГО ЛЕЗВИЯ	ALBU-25-26 BASKI PABUCU / CLAMP / Прижим
	ABK-03	LAMA BLOĞU için / For BLADE BLOCK / ДЛЯ БЛОКА СМЕННОГО ЛЕЗВИЯ	ALBU-20-32 BASKI PABUCU / CLAMP / Прижим
	ABK-04	LAMA BLOĞU için / For BLADE BLOCK / ДЛЯ БЛОКА СМЕННОГО ЛЕЗВИЯ	ALBU-25-32, ALBU-32-32 BASKI PABUCU / CLAMP / Прижим

Ürün Resmi Product Picture ИЗОБРАЖЕНИЕ	LAMA ANAHTARI / BLADE KEY / КЛЮЧ ДЛЯ ОТРЕЗНОГО НOЖА	
	Ürün Kodu Product Code / КОД	Ürün Detayı / Product Detail / ОПИСАНИЕ
	ALA-01	AKL LAMA ANAHTARI / for BLADE KEY / КЛЮЧ ДЛЯ ОТРЕЗНОГО НOЖА

Ürün Resmi Product Picture ИЗОБРАЖЕНИЕ	ALYAN ANAHTARLARI / ALLEN KEYS / ШЕСТИГРАННЫЕ КЛЮЧИ		
	Ürün Kodu Product Code / КОД	Ürün Detayı / Product Detail / ОПИСАНИЕ	
	AAL-01-2	2 mm	ALYAN ANAHTARI / ALLEN KEYS / ШЕСТИГРАННЫЕ КЛЮЧИ
	AAL-02-2.5	2.5 mm	ALYAN ANAHTARI / ALLEN KEYS / ШЕСТИГРАННЫЕ КЛЮЧИ
	AAL-03-3	3 mm	ALYAN ANAHTARI / ALLEN KEYS / ШЕСТИГРАННЫЕ КЛЮЧИ
	AAL-05-4	4 mm	ALYAN ANAHTARI / ALLEN KEYS / ШЕСТИГРАННЫЕ КЛЮЧИ
	AAL-07-5	5 mm	ALYAN ANAHTARI / ALLEN KEYS / ШЕСТИГРАННЫЕ КЛЮЧИ
	AAL-08-6	6 mm	ALYAN ANAHTARI / ALLEN KEYS / ШЕСТИГРАННЫЕ КЛЮЧИ
	AAL-09-1.5	1.5 mm	ALYAN ANAHTARI / ALLEN KEYS / ШЕСТИГРАННЫЕ КЛЮЧИ
	AAL-11-8	8 mm	ALYAN ANAHTARI / ALLEN KEYS / ШЕСТИГРАННЫЕ КЛЮЧИ
	AAL-12-10	10 mm	ALYAN ANAHTARI / ALLEN KEYS / ШЕСТИГРАННЫЕ КЛЮЧИ

Ürün Resmi Product Picture ИЗОБРАЖЕНИЕ	TORK ANAHTARLARI / TORX KEYS / КЛЮЧ TORX		
	Ürün Kodu Product Code / КОД	Ürün Detayı / Product Detail / ОПИСАНИЕ	
	80-T06	T06 TORK ANAHTARI / TORX KEY / КЛЮЧ TORX	
	80-T07	T07 TORK ANAHTARI / TORX KEY / КЛЮЧ TORX	
	80-T08	T08 TORK ANAHTARI / TORX KEY / КЛЮЧ TORX	
	80-T10	T10 TORK ANAHTARI / TORX KEY / КЛЮЧ TORX	
	80-T15	T15 TORK ANAHTARI / TORX KEY / КЛЮЧ TORX	
	80-T20	T20 TORK ANAHTARI / TORX KEY / КЛЮЧ TORX	
	81-T15	T15 T-TİP TORK ANAHTARI / T-TYPE TORX KEY / T-ТИП КЛЮЧ TORX	
	81-T20	T20 T-TİP TORK ANAHTARI / T-TYPE TORX KEY / T-ТИП КЛЮЧ TORX	

KOD / CODE Код	AÇIKLAMA / DESCRIPTION	ОПИСАНИЕ	S.N. / P.N. СТР.	KOD / CODE Код	AÇIKLAMA / DESCRIPTION	ОПИСАНИЕ	S.N. / P.N. СТР.
A/SCLCR/L ..	Boring Bars SET	Наборы Расточных Державок	110	AEMR-QP..	Face and Copy Mills	Концевые Радиусные Фрезы	233
A/SDUCR/L ..	Boring Bars SET	Наборы Расточных Державок	111	AEMR-QP..	Modular End Mills	Сменные Фрезерные Головки (Крепление под Резьбу)	251
AAKT-IG-R/L ..	Face External Grooving Tool Holders	Державки для Обработки Торцевых Канавок	149	AEMR-RC..	Modular End Mills	Сменные Фрезерные Головки (Крепление под Резьбу)	249
AAKT-KG-R/L ..	Face External Grooving Tool Holders	Державки для Обработки Торцевых Канавок	147	AEMR-RD..	Modular End Mills	Сменные Фрезерные Головки (Крепление под Резьбу)	252
AAKT-KZ-R/L ..	Face External Grooving Tool Holders	Державки для Обработки Торцевых Канавок	148	AEMR-RP..	Face and Copy Mills	Концевые Радиусные Фрезы	232-233
AAUT-T20-R/L ..	Corner Reliefs Grooving Toolholders	Используйте резцы серии AAUT-T20R...	14	AEMR-RA..	Modular End Mills	Сменные Фрезерные Головки (Крепление под Резьбу)	250
ABHR ..	Adjustable Rough Boring Heads	Регулируемые Расточные Головки для Чернового Точения	199	AEMR-RV..	Face and Copy End Mills	Концевые Радиусные Фрезы	232
ABHRS ..	Adjustable Rough Boring Heads Body	Корпус Регулируемой Расточной Головки для Чернового Точения	200	AEMR-RY..	Modular End Mills	Сменные Фрезерные Головки (Крепление под Резьбу)	251
ABT-B4..	Broaching Toolholders	Долбяки с СМП	16	AET	Eccentric Adaptor For U-Drill	Эксцентрический Адаптер для Сверел	191
ACBM ..	Countersink Open Milling Tools	Зенковки для Отверстий	207	AFM42C-XD..	Face Milling	Торцевые Фрезы	268
ACM ..	Chamfering End Mills	Концевые Фрезы Для Снятия Фаски (Зенковки)	205	AFM43(C)-OD..	Face Milling	Торцевые Фрезы	268-269
ACM45-SP..	Chamfering End Mills	Концевые Фрезы Для Снятия Фаски (Зенковки)	206	AFM43(C)-OF..	Face Milling	Торцевые Фрезы	269-304
ACPB7..	Pipe Beveling Tools	Торцевочная Головка для Цилиндрических Заготовок	121	AFM43-ON..	Face Milling	Торцевые Фрезы	270
ADCR	Drill Chamfering Ring Tools	Кольца для Снятия Фаски	189	AFM44-ON..	Face Milling	Торцевые Фрезы	270
ADKT-123-R/L ..	External Grooving Tool Holders	Державки для Обработки Наружных Канавок	138	AFM45(L)-HN..	Face Milling	Торцевые Фрезы	271
ADKT-151.22-R/L ..	External Grooving Tool Holders	Державки для Обработки Наружных Канавок	139	AFM45(L)-SE..	Face Milling	Торцевые Фрезы	272
ADKT-151.23-R/L ..	External Grooving Tool Holders	Державки для Обработки Наружных Канавок	139	AFM45(S)-SE	Face Milling	Торцевые Фрезы	272
ADKT-154.91-R/L ..	External Grooving Tool Holders	Державки для Обработки Наружных Канавок	140	AFM45C(L)-HN..	Face Milling	Торцевые Фрезы	304
ADKT-ARN-R/L ..	External Grooving Tool Holders	Державки для Обработки Наружных Канавок	140	AFM45C(L)-SN..	Face Milling	Торцевые Фрезы	273-274-275
ADKT-CD-R/L ..	External Grooving Tool Holders	Державки для Обработки Наружных Канавок	144	AFM45C-XN..	Face Milling	Торцевые Фрезы	305
ADKT-GP-R/L ..	External Grooving Tool Holders	Державки для Обработки Наружных Канавок	143	AFM45-NN..	Face Milling	Торцевые Фрезы	271
ADKT-H22-R/L ..	External Grooving Tool Holders	Державки для Обработки Наружных Канавок	142	AFM45-ON..	Face Milling	Торцевые Фрезы	275
ADKT-HK-R/L ..	External Grooving Tool Holders	Державки для Обработки Наружных Канавок	134	AFM45-SA..	Face Milling	Торцевые Фрезы	274
ADKT-H-R/L ..	External Grooving Tool Holders	Державки для Обработки Наружных Канавок	134	AFM45-XN..	Face Milling	Торцевые Фрезы	276
ADKT-HS223-R/L ..	External Grooving Tool Holders	Державки для Обработки Наружных Канавок	134	AFM66-PN..	Face Milling	Торцевые Фрезы	276
ADKT-IDC-R/L ..	External Grooving Tool Holders	Державки для Обработки Наружных Канавок	137	AFM67-PN..	Face Milling	Торцевые Фрезы	277
ADKT-IGI-R/L ..	External Grooving Tool Holders	Державки для Обработки Наружных Канавок	137	AFM75-AP..	Face Milling	Торцевые Фрезы	277
ADKT-IG-R/L ..	External Grooving Tool Holders	Державки для Обработки Наружных Канавок	137	AFM75C-SP..	Face Milling	Торцевые Фрезы	305
ADKT-IGTN-R/L ..	External Grooving Tool Holders	Державки для Обработки Наружных Канавок	137	AFM75-XO..	Face Milling	Торцевые Фрезы	278
ADKT-I-R/L ..S	External Grooving (Swiss Type) Tool Holders	Державки для Обработки Наружных Канавок для Токарных Станков Швейцарского Типа	146	AFM88C-SN..	Face Milling	Торцевые Фрезы	279-280
ADKT-ITG-R/L ..	External Grooving Tool Holders	Державки для Обработки Наружных Канавок	136	AFM88-SN..	Face Milling	Торцевые Фрезы	278-279
ADKT-KG-R/L ..S	External Grooving (Swiss Type) Tool Holders	Державки для Обработки Наружных Канавок для Токарных Станков Швейцарского Типа	145	AFM89-SN..	Face Milling	Торцевые Фрезы	281
ADKT-KM-R/L ..	External Grooving Tool Holders	Державки для Обработки Наружных Канавок	138	AFM90(L)-LN..	Face Milling	Торцевые Фрезы	288-289-290-291
ADKT-K-R/L ..	External Grooving Tool Holders	Державки для Обработки Наружных Канавок	132	AFM90(L)-SD..	Face Milling	Торцевые Фрезы	293-294
ADKT-LGC-R/L ..	External Grooving Tool Holders	Державки для Обработки Наружных Канавок	142	AFM90-3P..	Face Milling	Торцевые Фрезы	299
ADKT-SDC-R/L ..S	External Grooving (Swiss Type) Tool Holders	Державки для Обработки Наружных Канавок для Токарных Станков Швейцарского Типа	144	AFM90-490..	Face Milling	Торцевые Фрезы	292
ADKT-SWC-R/L ..	External Grooving Tool Holders	Державки для Обработки Наружных Канавок	141	AFM90-4N..	Face Milling	Торцевые Фрезы	299
ADKT-T12P-R/L	Poly-V Grooving Toolholders	РПЧУИ Инструмент для обработки канавок под клиновые ремни	12	AFM90-AD..	Face Milling	Торцевые Фрезы	281-282
ADKT-TD-R/L ..	External Grooving (Swiss Type) Tool Holders	Державки для Обработки Наружных Канавок для Токарных Станков Швейцарского Типа	144	AFM90-AN..	Face Milling	Торцевые Фрезы	283-284
ADKT-TD-R/L ..S	External Grooving (Swiss Type) Tool Holders	Державки для Обработки Наружных Канавок для Токарных Станков Швейцарского Типа	144	AFM90-AO..	Face Milling	Торцевые Фрезы	285
ADKT-WGX..R/L ..	External Grooving (Swiss Type) Tool Holders	Державки для Обработки Наружных Канавок для Токарных Станков Швейцарского Типа	146	AFM90-AP..	Face Milling	Торцевые Фрезы	285-286
ADKT-WGX..R/L ..	External Grooving (Swiss Type) Tool Holders	Державки для Обработки Наружных Канавок	143	AFM90-AX..	Face Milling	Торцевые Фрезы	287
ADKT-ZCC1-R/L ..	External Grooving Tool Holders	Державки для Обработки Наружных Канавок	135	AFM90-BD..	Face Milling	Торцевые Фрезы	287
ADKT-ZCC2-R/L ..	External Grooving Tool Holders	Державки для Обработки Наружных Канавок	135	AFM90C-TP..	Face Milling	Торцевые Фрезы	306
ADKT-ZCC2-R/L ..S	External Grooving (Swiss Type) Tool Holders	Державки для Обработки Наружных Канавок для Токарных Станков Швейцарского Типа	145	AFM90-R290..	Face Milling	Торцевые Фрезы	291
AEKR/L ..	Economic Cutting Tools	MULTI TOOL - Сверление	196	AFM90-R390..	Face Milling	Торцевые Фрезы	292
AEM90-3P..	End Mills	Концевые Фрезы	230	AFM90-RT..	Face Milling	Торцевые Фрезы	293
AEM90-4N..	End Mills	Концевые Фрезы	231	AFM90-SE..	Face Milling	Торцевые Фрезы	294-295
AEM90-AD..	End Mills	Концевые Фрезы	208-209-210	AFM90-SP..	Face Milling	Торцевые Фрезы	295
AEM90-AD..	Modular End Mills	Сменные Фрезерные Головки (Крепление под Резьбу)	245	AFM90-TN..	Face Milling	Торцевые Фрезы	296
AEM90-AN..	End Mills	Концевые Фрезы	210-211	AFM90-TP..	Face Milling	Торцевые Фрезы	296
AEM90-AO..	End Mills	Концевые Фрезы	217	AFM90-WN..	Face Milling	Торцевые Фрезы	297
AEM90-AO..	Modular End Mills	Сменные Фрезерные Головки (Крепление под Резьбу)	244	AFM90-XN..	Face Milling	Торцевые Фрезы	298
AEM90-AP..	End Mills	Концевые Фрезы	212-213-214-215-216-217	AFM90-XO..	Face Milling	Торцевые Фрезы	298
AEM90-AP..	Modular End Mills	Сменные Фрезерные Головки (Крепление под Резьбу)	246	AFMR(C)-RD..	Face and Copy Milling	Торцевые и Копировальные Фрезы	301
AEM90-AX..	End Mills	Концевые Фрезы	218-219	AFMR-QP..	Face and Copy Milling	Торцевые и Копировальные Фрезы	303
AEM90-AX..	Modular End Mills	Сменные Фрезерные Головки (Крепление под Резьбу)	245	AFMR-RC..	Face and Copy Milling	Торцевые и Копировальные Фрезы	300
AEM90-AZ..	End Mills	Концевые Фрезы	220	AFMR-RP..	Face and Copy Milling	Торцевые и Копировальные Фрезы	302
AEM90-BD..	End Mills	Концевые Фрезы	221	AFMR-RY..	Face and Copy Milling	Торцевые и Копировальные Фрезы	303
AEM90-DC..	Modular End Mills	Сменные Фрезерные Головки (Крепление под Резьбу)	247	AHFM(C)-SD..	High Feed End Mills	Высокопроизводительные Концевые Фрезы	239
AEM90-ED..	End Mills	Концевые Фрезы	222	AHFM(C)-SD..	High Feed Milling Tools	Высокопроизводительные Торцевые Фрезы	310
AEM90-LN..	End Mills	Концевые Фрезы	222-223	AHFM(C)-SD..	Modular High Feed End Mills	Высокопроизводительные Сменные Фрезерные Головки	256
AEM90-R390..	End Mills	Концевые Фрезы	224	AHFM(C)-WD..	High Feed End Mills	Высокопроизводительные Концевые Фрезы	242-243
AEM90-R390..	Modular End Mills	Сменные Фрезерные Головки (Крепление под Резьбу)	248	AHFM(C)-WD..	Modular High Feed End Mills	Высокопроизводительные Сменные Фрезерные Головки	259
AEM90-RT..	End Mills	Концевые Фрезы	225	AHFM-BL..	High Feed End Mills	Высокопроизводительные Концевые Фрезы	236
AEM90-RT..	Modular End Mills	Сменные Фрезерные Головки (Крепление под Резьбу)	247	AHFM-BL..	High Feed Milling Tools	Высокопроизводительные Торцевые Фрезы	307
AEM90-SE..	End Mills	Концевые Фрезы	226	AHFM-BL..	Modular High Feed End Mills	Высокопроизводительные Сменные Фрезерные Головки	253
AEM90-SO..	End Mills	Концевые Фрезы	226	AHFM-BN..	High Feed End Mills	Высокопроизводительные Концевые Фрезы	235
AEM90-SPGT..	End Mills	Концевые Фрезы	227	AHFM-C-JD..	High Feed End Mills	Высокопроизводительные Концевые Фрезы	237
AEM90-TNG..	End Mills	Концевые Фрезы	227	AHFM-C-JD..	High Feed Milling Tools	Высокопроизводительные Торцевые Фрезы	309
AEM90-WN..	End Mills	Концевые Фрезы	228	AHFM-C-JD..	Modular High Feed End Mills	Высокопроизводительные Сменные Фрезерные Головки	256
AEM90-WN..	Modular End Mills	Сменные Фрезерные Головки (Крепление под Резьбу)	248	AHFM-C-WD..	High Feed Milling Tools	Высокопроизводительные Торцевые Фрезы	312
AEM90-XC..	End Mills	Концевые Фрезы	228	AHFM-ED..	Modular High Feed End Mills	Высокопроизводительные Сменные Фрезерные Головки	253
AEM90-XD..	End Mills	Концевые Фрезы	229	AHFM-EN..	High Feed End Mills	Высокопроизводительные Концевые Фрезы	237
AEM90-XO..	End Mills	Концевые Фрезы	229	AHFM-EN..	High Feed Milling Tools	Высокопроизводительные Торцевые Фрезы	308
AEM90-ZC..	End Mills	Концевые Фрезы	230	AHFM-EN..	Modular High Feed End Mills	Высокопроизводительные Сменные Фрезерные Головки	254
AEM90-ZP..	End Mills	Концевые Фрезы	231	AHFM-EO..	High Feed End Mills	Высокопроизводительные Концевые Фрезы	235
AEM95(C)-XD..	Modular End Mills	Сменные Фрезерные Головки (Крепление под Резьбу)	249	AHFM-EP..	High Feed End Mills	Высокопроизводительные Концевые Фрезы	236
AEMR(C)-RD..	Face and Copy End Mills	Концевые Радиусные Фрезы	234	AHFM-EP..	High Feed Milling Tools	Высокопроизводительные Торцевые Фрезы	308
				AHFM-EP..	Modular High Feed End Mills	Высокопроизводительные Сменные Фрезерные Головки	254
				AHFM-LN..	High Feed End Mills	Высокопроизводительные Концевые Фрезы	238
				AHFM-LN..	Modular High Feed End Mills	Высокопроизводительные Сменные Фрезерные Головки	255

KOD / CODE Код	AÇIKLAMA / DESCRIPTION	ОПИСАНИЕ	S.N. / P.N. СТР.
AHFM-LO..	High Feed End Mills	Высокопроизводительные Концевые Фрезы	238
AHFM-LO..	High Feed Milling Tools	Высокопроизводительные Торцевые Фрезы	309
AHFM-LO..	Modular High Feed End Mills	Высокопроизводительные Сменные Фрезерные Головки	255
AHFM-LP..	High Feed End Mills	Высокопроизводительные Концевые Фрезы	239
AHFM-SO..	High Feed End Mills	Высокопроизводительные Концевые Фрезы	240
AHFM-SO..	High Feed Milling Tools	Высокопроизводительные Торцевые Фрезы	311
AHFM-SO..	Modular High Feed End Mills	Высокопроизводительные Сменные Фрезерные Головки	257
AHFM-SP..	High Feed End Mills	Высокопроизводительные Концевые Фрезы	240
AHFM-SP..	High Feed Milling Tools	Высокопроизводительные Торцевые Фрезы	311
AHFM-SP..	Modular High Feed End Mills	Высокопроизводительные Сменные Фрезерные Головки	258
AHFM-WN..	High Feed End Mills	Высокопроизводительные Концевые Фрезы	243
AHFM-WN..	High Feed Milling Tools	Высокопроизводительные Торцевые Фрезы	313
AHFM-WN..	Modular High Feed End Mills	Высокопроизводительные Сменные Фрезерные Головки	260
AHFM-WO..	High Feed End Mills	Высокопроизводительные Концевые Фрезы	244
AHFM-YO..	High Feed End Mills	Высокопроизводительные Концевые Фрезы	242
AHFM-YP..	High Feed End Mills	Высокопроизводительные Концевые Фрезы	241
AHFM-YP..	Modular High Feed End Mills	Высокопроизводительные Сменные Фрезерные Головки	258
AHM ..	Helix Chamfer Milling Tools	Спиральные Фрезы для Снятия Фаски	206
AHM90-AP..	Helix End Mills	Спиральная Концевая Фреза (Кукурузная Фреза)	267
AIKT ..	Mini Grooving Tool	Мини Державка Для Обработки Внутренних Канавок	161
AIKT-123-R/L ..	Internal Grooving Tool Holders	Державки для Обработки Внутренних Канавок	155
AIKT-154-91-R/L ..	Internal Grooving Tool Holders	Державки для Обработки Внутренних Канавок	155
AIKT-GP-R/L ..	Internal Grooving Tool Holders	Державки для Обработки Внутренних Канавок	159
AIKT-HK-R/L ..	Internal Grooving Tool Holders	Державки для Обработки Внутренних Канавок	154
AIKT-H-R/L ..	Internal Grooving Tool Holders	Державки для Обработки Внутренних Канавок	153
AIKT-HS223-R/L ..	Internal Grooving Tool Holders	Державки для Обработки Внутренних Канавок	154
AIKT-IGE-R/L ..	Internal Grooving Tool Holders	Державки для Обработки Внутренних Канавок	157
AIKT-IGI-R/L ..	Internal Grooving Tool Holders	Державки для Обработки Внутренних Канавок	157
AIKT-IG-R/L ..	Internal Grooving Tool Holders	Державки для Обработки Внутренних Канавок	158
AIKT-I-R/L ..	Internal Grooving Tool Holders	Державки для Обработки Внутренних Канавок	158
AIKT-ITG-R/L ..	Internal Grooving Tool Holders	Державки для Обработки Внутренних Канавок	159
AIKT-KG-R/L ..	Internal Grooving Tool Holders	Державки для Обработки Внутренних Канавок	153
AIKT-KM-R/L ..	Internal Grooving Tool Holders	Державки для Обработки Внутренних Канавок	154
AIKT-K-R/L ..	Internal Grooving Tool Holders	Державки для Обработки Внутренних Канавок	152
AIKT-QC...-R/L ..	Internal Grooving Tool Holders	Державки для Обработки Внутренних Канавок	160
AIKT-SGC-R ..	Internal Grooving Tool Holders	Державки для Обработки Внутренних Канавок	160
AIKT-TD-R/L ..	Internal Grooving Tool Holders	Державки для Обработки Внутренних Канавок	156
AIKT-ZCC2-R/L ..	Internal Grooving Tool Holders	Державки для Обработки Внутренних Канавок	156
AKCR ..	Adjustable Rough Boring Heads Cartridge	Картриджи Регулируемой Расточной Головки для Чернового Точения	201
AKL-123 ..	Blades	Ножи	151
AKL-I ..	Blades	Ножи	150
AKL-TD ..	Blades	Ножи	150
AKSR ..	Adjustable Rough Boring Heads Cartridge	Картриджи Регулируемой Расточной Головки для Чернового Точения	201
ALBU ..	Blocks For Blades	Блоки к Сменным Ножам	151
ALKT-ZCC2-R/L ..	Face External Grooving Tool Holders	Державки для Обработки Торцевых Канавок	149
APMR-BNM..	Ball Nose End Mills	Сферические Концевые Фрезы	260
APMR-P32..	Ball Nose End Mills	Сферические Концевые Фрезы	261
APMR-P32..	Ball Nose Modular End Mills	Сферические Фрезерные Головки (Крепление под Резьбу)	262
APMR-RO..	Ball Nose End Mills	Сферические Концевые Фрезы	261
APMR-SWB..	Ball Nose Modular End Mills	Сферические Фрезерные Головки (Крепление под Резьбу)	263
APMR-XP..	Ball Nose End Mills	Сферические Концевые Фрезы	262
APMR-XP..	Ball Nose Modular End Mills	Сферические Фрезерные Головки (Крепление под Резьбу)	263
ASDM-CC..	Disc Milling	Дисковые Трехсторонние Фрезы	317
ASDM-SPGT..	Disc Milling	Дисковые Трехсторонние Фрезы	316
ATM..	Thread Milling Tools	Резьбонарезные Фрезы	265
ATM60..	Thread Milling Tools	Резьбонарезные Фрезы	266
ATSM90-CC..	T Slot Milling	T-Образные Фрезы	314
ATSM90-SP..	T Slot Milling	T-Образные Фрезы	315
ATSMR-RD..	T Slot Milling	T-Образные Фрезы	315
ATUM .. xD2 KDR ..	U-Drill	Сверла	183
ATUM .. xD2 SP ..	U-Drill	Сверла	172-173
ATUM .. xD2 SPGT ..	U-Drill	Сверла	177
ATUM .. xD2 WCM ..	U-Drill	Сверла	166-167
ATUM .. xD3 KDR ..	U-Drill	Сверла	184
ATUM .. xD3 SO ..	U-Drill	Сверла	181
ATUM .. xD3 SP ..	U-Drill	Сверла	174-175
ATUM .. xD3 SPGT ..	U-Drill	Сверла	178-179
ATUM .. xD3 WCM ..	U-Drill	Сверла	168-169
ATUM .. xD4 KDR ..	U-Drill	Сверла	183
ATUM .. xD4 SO ..	U-Drill	Сверла	182
ATUM .. xD4 SP ..	U-Drill	Сверла	176
ATUM .. xD4 SPGT ..	U-Drill	Сверла	180
ATUM .. xD4 WCM ..	U-Drill	Сверла	170-171
ATUM xD2 SOMT ..	U-Drill	Сверла	185
ATUM xD3 SOMT ..	U-Drill	Сверла	186
ATUM xD4 SOMT ..	U-Drill	Сверла	187
ATUM xD5 SOMT ..	U-Drill	Сверла	188
ATW...	Whirling Toolholders	Инструмент для вихревого резьбозаготовки	25
AVTT..	Screwed Tool Holders	Оправки для Сменных Головок	264
B11..	Valve Seat Inserts	Инструмент для Обработки Вкладышей Седла Клапана	22-23
B41.. - B42..	Broaching Inserts	Долбяки с СМП	16-17-18
CCLNR/L ..	External Tool Holders	Державки для Наружного Точения	53

KOD / CODE Код	AÇIKLAMA / DESCRIPTION	ОПИСАНИЕ	S.N. / P.N. СТР.
CDJNR/L ..	External Tool Holders	Державки для Наружного Точения	53
CDNNN ..	External Tool Holders	Державки для Наружного Точения	54
CKJNR/L ..	External Tool Holders	Державки для Наружного Точения	52
CKUNR/L ..	Internal Tool Holders	Расточные Державки	84
CRDCN ..	External Tool Holders	Державки для Наружного Точения	54
CRDCR/L ..	External Tool Holders	Державки для Наружного Точения	55
CSDNN ..	External Tool Holders	Державки для Наружного Точения	55
CSKNR/L ..	External Tool Holders	Державки для Наружного Точения	56
CSRNR/L ..	External Tool Holders	Державки для Наружного Точения	56
CSSNR/L ..	External Tool Holders	Державки для Наружного Точения	57
CTJNR/L ..	External Tool Holders	Державки для Наружного Точения	57
E/SCLCR/L ..	Boring Bars SET	Наборы Расточных Державок	110
E/SDUCR/L ..	Boring Bars SET	Наборы Расточных Державок	111
MCLNR/L ..	Internal Tool Holders	Расточные Державки	86
MDUNR/L ..	Internal Tool Holders	Расточные Державки	86
MTENN ..	External Tool Holders	Державки для Наружного Точения	41
MTFNR/L ..	Internal Tool Holders	Расточные Державки	87
MTJNR/L ..	External Tool Holders	Державки для Наружного Точения	41
MT-NR/L ..	Internal Tool Holders	Расточные Державки	87
MTQNR/L ..	Internal Tool Holders	Расточные Державки	88
MTUNR/L ..	Internal Tool Holders	Расточные Державки	88
MwLNR/L ..	External Tool Holders	Державки для Наружного Точения	42
MwLNR/L ..	Internal Tool Holders	Расточные Державки	89
MwMNN ..	External Tool Holders	Державки для Наружного Точения	42
PCBNR/L ..	External Tool Holders	Державки для Наружного Точения	44
PCLNR/L ..	External Tool Holders	Державки для Наружного Точения	44
PCLNR/L ..	Internal Tool Holders	Расточные Державки	91
PCMNN ..	External Tool Holders	Державки для Наружного Точения	45
PDJNR/L ..	External Tool Holders	Державки для Наружного Точения	45
PDNNN ..	External Tool Holders	Державки для Наружного Точения	46
PDQNR/L ..	Internal Tool Holders	Расточные Державки	92
PDUNR/L ..	Internal Tool Holders	Расточные Державки	93
PDXNR/L ..	Internal Tool Holders	Расточные Державки	92
PSBNR/L ..	External Tool Holders	Державки для Наружного Точения	46
PSDNN ..	Cartridge	Картриджи	120
PSDNN ..	External Tool Holders	Державки для Наружного Точения	47
PSKNR/L ..	Cartridge	Картриджи	119
PSKNR/L ..	External Tool Holders	Державки для Наружного Точения	47
PSKNR/L ..	Internal Tool Holders	Расточные Державки	93
PSSNR/L ..	External Tool Holders	Державки для Наружного Точения	48
PTFNR/L ..	Cartridge	Картриджи	119
PTFNR/L ..	External Tool Holders	Державки для Наружного Точения	48
PTGNR/L ..	External Tool Holders	Державки для Наружного Точения	49
PTJNR/L ..	External Tool Holders	Державки для Наружного Точения	49
PTTNR/L ..	External Tool Holders	Державки для Наружного Точения	50
PTUNR/L ..	Internal Tool Holders	Расточные Державки	94
PwLNR/L ..	External Tool Holders	Державки для Наружного Точения	50
PwLNR/L ..	Internal Tool Holders	Расточные Державки	95
S/SCLCR/L ..	Boring Bars SET	Наборы Расточных Державок	110
S/SDUCR/L ..	Boring Bars SET	Наборы Расточных Державок	111
SCACR/L ..	Engine Overhaul Cartridge	Хонингованные Картриджи	114
SCACR/L ..	External Tool Holders	Державки для Наружного Точения	59
SCACR/L ..-S	External Tool Holders Swiss Type	Державки для Наружного Точения Швейцарских Станков Автоматов	71
SCFCR/L	Spare Parts Of Cartridge	Запасные Части к Картриджам	120
SCFCR/L ..	Cartridge	Картриджи	116
SCFCR/L ..	Internal Tool Holders	Расточные Державки	98
SCLCR/L ..	Boring Bars With Carbide Shank	Расточная державка из Твердосплавного Карбида	109
SCLCR/L ..	External Tool Holders	Державки для Наружного Точения	59
SCLCR/L ..	Internal Tool Holders	Расточные Державки	97
SCLCR/L ..-S	External Tool Holders Swiss Type	Державки для Наружного Точения Швейцарских Станков Автоматов	72
SCMCN ..	Engine Overhaul Cartridge	Хонингованные Картриджи	115
SCMCN ..	External Tool Holders	Державки для Наружного Точения	60
SCSCR/L	Spare Parts Of Cartridge	Запасные Части к Картриджам	120
SCSCR/L ..	Cartridge	Картриджи	116
SDACR/L ..-S	External Tool Holders Swiss Type	Державки для Наружного Точения Швейцарских Станков Автоматов	72
SD-CR/L ..	Internal Tool Holders	Расточные Державки	98
SDHCR/L ..	External Tool Holders	Державки для Наружного Точения	60
SDJCR/L ..	External Tool Holders	Державки для Наружного Точения	61
SDJCR/L ..-S	External Tool Holders Swiss Type	Державки для Наружного Точения Швейцарских Станков Автоматов	73
SDNCN ..	External Tool Holders	Державки для Наружного Точения	61
SDPCR/L ..	Internal Tool Holders	Расточные Державки	99
SDQCR/L ..	Internal Tool Holders	Расточные Державки	99
SDUCR/L ..	Boring Bars With Carbide Shank	Расточная державка из Твердосплавного Карбида	109
SDUCR/L ..	Internal Tool Holders	Расточные Державки	100
SDXCR/L ..	Internal Tool Holders	Расточные Державки	101
SER/L ..	External Threading Tool Holders	Державка для Нарезания Наружной Резьбы	124
SIR/L ..	Internal Threading Tool Holders	Державка для Нарезания Внутренней Резьбы	125
SRDCN ..	External Tool Holders	Державки для Наружного Точения	62
SRDCR/L ..	External Tool Holders	Державки для Наружного Точения	63
SRGCR/L ..	External Tool Holders	Державки для Наружного Точения	63
SRGCR/L ..	Internal Tool Holders	Расточные Державки	101
SRHCR/L ..	External Tool Holders	Державки для Наружного Точения	64

KOD / CODE Код	AÇIKLAMA / DESCRIPTION	ОПИСАНИЕ	S.N. / P.N. СТР.	KOD / CODE Код	AÇIKLAMA / DESCRIPTION	ОПИСАНИЕ	S.N. / P.N. СТР.
SRXCR/L ..	External Tool Holders	Державки для Наружного Точения	64	1220-..	Spare Parts	Запасные Части	331
SSDCN ..	External Tool Holders	Державки для Наружного Точения	65	1315-..	Spare Parts	Запасные Части	332-333
SSKCR/L ..	Cartridge	Картриджи	117	1415-..	Spare Parts	Запасные Части	332-333
SSSCR/L ..	External Tool Holders	Державки для Наружного Точения	65	1420-..	Spare Parts	Запасные Части	332-333
SSSCR/L ..	Internal Tool Holders	Расточные Державки	102	1510-..	Spare Parts	Запасные Части	332-333
STCCN ..	External Tool Holders	Державки для Наружного Точения	67	1515-..	Spare Parts	Запасные Части	332-333
ST-CR/L ..	Internal Tool Holders	Расточные Державки	102	1520-..	Spare Parts	Запасные Части	332-333
STFCR/L	Spare Parts Of Cartridge	Запасные Части к Картриджам	120	1615-..	Spare Parts	Запасные Части	332-333
STFCR/L ..	Cartridge	Картриджи	117	1620-..	Spare Parts	Запасные Части	332-333
STFCR/L ..	External Tool Holders	Державки для Наружного Точения	66	1707-..	Spare Parts	Запасные Части	332-333
STFCR/L ..	Internal Tool Holders	Расточные Державки	103	1710-..	Spare Parts	Запасные Части	332-333
STGCR/L ..	External Tool Holders	Державки для Наружного Точения	66	1720-..	Spare Parts	Запасные Части	332-333
STGCR/L ..-S	External Tool Holders Swiss Type	Державки для Наружного Точения Швейцарских Станков Автоматов	73	1904-..	Spare Parts	Запасные Части	329
STJCR/L ..	External Tool Holders	Державки для Наружного Точения	67	2004-..	Spare Parts	Запасные Части	329
STSCR/L	Spare Parts Of Cartridge	Запасные Части к Картриджам	120	2405-..	Spare Parts	Запасные Части	335
STSCR/L ..	Cartridge	Картриджи	118	2406-..	Spare Parts	Запасные Части	335
STTCR/L	Spare Parts Of Cartridge	Запасные Части к Картриджам	120	2407-..	Spare Parts	Запасные Части	335
STTCR/L ..	Cartridge	Картриджи	118	2408-..	Spare Parts	Запасные Части	335
STUCR/L ..	External Tool Holders	Державки для Наружного Точения	68	2503-..	Spare Parts	Запасные Части	335
STUCR/L ..	Internal Tool Holders	Расточные Державки	103	2504-..	Spare Parts	Запасные Части	335
STUPR/L ..	Internal Tool Holders	Расточные Державки	104	2505-..	Spare Parts	Запасные Части	335
STXCR/L ..	Engine Overhaul Cartridge	Хонингованные Картриджи	115	2506-..	Spare Parts	Запасные Части	335
SVACR/L ..-S	External Tool Holders Swiss Type	Державки для Наружного Точения Швейцарских Станков Автоматов	74	2508-..	Spare Parts	Запасные Части	335
SVHBR/L ..	External Tool Holders	Державки для Наружного Точения	68	2510-..	Spare Parts	Запасные Части	335
SVHCR/L ..	External Tool Holders	Державки для Наружного Точения	69	2514-..	Spare Parts	Запасные Части	335
SVJBR/L ..	External Tool Holders	Державки для Наружного Точения	69	2525-..	Spare Parts	Запасные Части	335
SVJBR/L ..	Internal Tool Holders	Расточные Державки	104	2600-..	Spare Parts	Запасные Части	334
SVJBR/L ..-S	External Tool Holders Swiss Type	Державки для Наружного Точения Швейцарских Станков Автоматов	74	2702-..	Spare Parts	Запасные Части	334
SVJCR/L ..	External Tool Holders	Державки для Наружного Точения	70	2703-..	Spare Parts	Запасные Части	334
SVJCR/L ..	Internal Tool Holders	Расточные Державки	107	2704-..	Spare Parts	Запасные Части	334
SVJCR/L ..-S	External Tool Holders Swiss Type	Державки для Наружного Точения Швейцарских Станков Автоматов	75	2715-..	Spare Parts	Запасные Части	334
SVQBR/L ..	Internal Tool Holders	Расточные Державки	105	2725-..	Spare Parts	Запасные Части	334
SVQCR/L ..	Internal Tool Holders	Расточные Державки	105	3006-..	Spare Parts	Запасные Части	332-333
SVUBR/L ..	Internal Tool Holders	Расточные Державки	106	3007-..	Spare Parts	Запасные Части	332-333
SVUCR/L ..	Internal Tool Holders	Расточные Державки	106	3008-..	Spare Parts	Запасные Части	332-333
SVVBN ..	External Tool Holders	Державки для Наружного Точения	70	3010-..	Spare Parts	Запасные Части	332-333
SVVCN ..	External Tool Holders	Державки для Наружного Точения	71	3015-..	Spare Parts	Запасные Части	332-333
SVXBR/L ..	Internal Tool Holders	Расточные Державки	107	3108-..	Spare Parts	Запасные Части	332-333
SwLCR ..	Internal Tool Holders	Расточные Державки	108	4006-..	Spare Parts	Запасные Части	332-333
SwUBR ..	Internal Tool Holders	Расточные Державки	108	4008-..	Spare Parts	Запасные Части	332-333
TO9..	Whirling Inserts	Пластины для вихревого резьбозероования	26	4010-..	Spare Parts	Запасные Части	332-333
T12.10	Poly-V Grooving Inserts	POLY-V Пластины для обработки канавок под клинковые ремни	12	4015-..	Spare Parts	Запасные Части	332-333
T20	Corner Reliefs Grooving Inserts	Используйте резыцы серии AAUT-T20R...	14	4020-..	Spare Parts	Запасные Части	332-333
TCBNR/L ..	External Tool Holders	Державки для Наружного Точения	31	4420-..	Spare Parts	Запасные Части	332-333
TCKNR/L ..	External Tool Holders	Державки для Наружного Точения	31	4615-..	Spare Parts	Запасные Части	332-333
TCLNR/L ..	External Tool Holders	Державки для Наружного Точения	32	80-..	Spare Parts	Запасные Части	337
TCLNR/L ..	Internal Tool Holders	Расточные Державки	80	81-..	Spare Parts	Запасные Части	337
TCMNN ..	External Tool Holders	Державки для Наружного Точения	32	AACN-..	Spare Parts	Запасные Части	324
TCZNN ..	External Tool Holders	Державки для Наружного Точения	33	AADN-..	Spare Parts	Запасные Части	324
TDHNR/L ..	External Tool Holders	Державки для Наружного Точения	33	AAL-..	Spare Parts	Запасные Части	337
TDJNR/L ..	External Tool Holders	Державки для Наружного Точения	34	AARC-..	Spare Parts	Запасные Части	324
TDNNN ..	External Tool Holders	Державки для Наружного Точения	34	AASD-..	Spare Parts	Запасные Части	324
TD-NR/L ..	Internal Tool Holders	Расточные Державки	80	AASE-..	Spare Parts	Запасные Части	324
TDQNR/L ..	Internal Tool Holders	Расточные Державки	81	AASN-..	Spare Parts	Запасные Части	324
TDUNR/L ..	Internal Tool Holders	Расточные Державки	81	AATN-..	Spare Parts	Запасные Части	324
TER/L ..	External Threading Tool Holders	Державка для Нарезания Наружной Резьбы	126	AAV-..	Spare Parts	Запасные Части	326-327
TIR/L ..	Internal Threading Tool Holders	Державка для Нарезания Внутренней Резьбы	127	AAVN-..	Spare Parts	Запасные Части	324
TSDNN ..	External Tool Holders	Державки для Наружного Точения	35	AAWN-..	Spare Parts	Запасные Части	324
TSKNR/L ..	External Tool Holders	Державки для Наружного Точения	35	AAY-..	Spare Parts	Запасные Части	330
TSKNR/L ..	Internal Tool Holders	Расточные Державки	82	ABK-..	Spare Parts	Запасные Части	337
TSSNR/L ..	External Tool Holders	Державки для Наружного Точения	36	ABKS-..	Spare Parts	Запасные Части	336
TTENN ..	External Tool Holders	Державки для Наружного Точения	36	ABPL-..	Spare Parts	Запасные Части	336
TTGNR/L ..	External Tool Holders	Державки для Наружного Точения	37	ACK-..	Spare Parts	Запасные Части	325
TTJNR/L ..	External Tool Holders	Державки для Наружного Точения	37	ACS-..	Spare Parts	Запасные Части	335
TT-NR/L ..	Internal Tool Holders	Расточные Державки	82	AS-01	Spare Parts	Запасные Части	335
TTUNR/L ..	Internal Tool Holders	Расточные Державки	83	AEV-..	Spare Parts	Запасные Части	331
TVHNR/L ..	External Tool Holders	Державки для Наружного Точения	38	AKS-..	Spare Parts	Запасные Части	324
TVJNR/L ..	External Tool Holders	Державки для Наружного Точения	38	AKV-..	Spare Parts	Запасные Части	326-328-329
TVUNR/L ..	Internal Tool Holders	Расточные Державки	83	AKY-..	Spare Parts	Запасные Части	328
TVVNN ..	External Tool Holders	Державки для Наружного Точения	39	ALA-..	Spare Parts	Запасные Части	337
TWLNR/L ..	External Tool Holders	Державки для Наружного Точения	39	ALV-..	Spare Parts	Запасные Части	329
TWLNR/L ..	Internal Tool Holders	Расточные Державки	84	AMK-..	Spare Parts	Запасные Части	325
VST-B11..	Valve Seat Toolholders	Инструмент для Обработки Вкладышей Седла Клапана	21-22	APL-..	Spare Parts	Запасные Части	329
1008-..	Spare Parts	Запасные Части	332-333	APM-..	Spare Parts	Запасные Части	330
1015-..	Spare Parts	Запасные Части	332-333	ATK-..	Spare Parts	Запасные Части	325
1020-..	Spare Parts	Запасные Части	332-333	ATS-..	Spare Parts	Запасные Части	324
1108-..	Spare Parts	Запасные Части	332-333				
1120-..	Spare Parts	Запасные Части	332-333				
1204-..	Spare Parts	Запасные Части	332-333				
1208-..	Spare Parts	Запасные Части	331				
1210-..	Spare Parts	Запасные Части	331				
1215-..	Spare Parts	Запасные Части	331				